

REP.	REFERENCE	PDS	NB	MZ
1	899.7001	3,9	1	260
2	899.7002	3,9	1	260
5	899.7005	2,6	1	260
6	899.7006	3,5	1	602
7	899.7007	2,3	1	260
8	899.7008	2,3	1	260
12	899.7012	1,8	1	140/080
13	899.7013	1,8	1	140/080
30	899.7030	3,0	1	602
31	899.7031	3,0	1	601
32	864.7032	1,3	2	
37	864.7037	0,2	2	
38	864.7038	3,4	1	
39	864.7039	3,4	1	
40	864.7040	2,2	1	080
41	864.7041	2,2	1	080
42	864.7042	1,9	1	260/080
43	864.7043	1,9	1	260/080
44	864.7044	0,8	2	
45	864.7045	0,3	2	
46	864.7046	1,9	1	200
47	864.7047	3,0	1	142
48	864.7048	3,0	1	141
49	864.7049	2,0	1	
50	864.7050	2,0	1	
51	864.7051	1,4	1	260
52	864.7052	1,4	1	260
53	864.7053	0,02	4	
54	864.7054	0,1	2	
55	864.7055	3,2	1	200
56	864.7056	3,2	1	200
57	864.7057	0,8	2	
58	864.7058	2,8	3	
59	899.7059	1,0	1	

M 8-25	2
M 10-20	4
M 10-25	2
M 10-35	4
M 10-60	2
M 12-25	16
M 12-30	10
M 12-80	4
M 12-150	2
M 14-80	2
M 16-30	2
CHc TB 12-25	12
M 14	2
M 16	2

○ Avec ou sans mécanique  
With or without mechanical elements  
Con o senza parti meccaniche  
Mit oder ohne Aggregate  
Con ó sin mecanica desmontada

## RENAULT

# 899.300

83 Kg 12.04.2002 427-D-29G

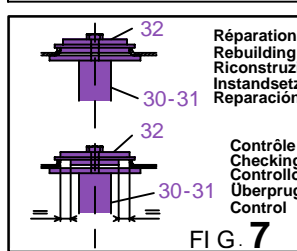
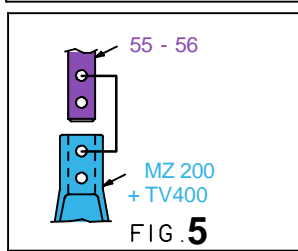
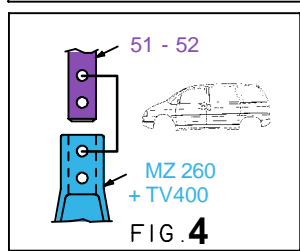
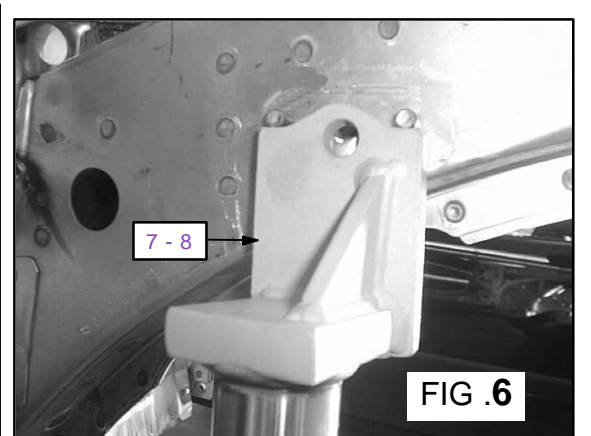
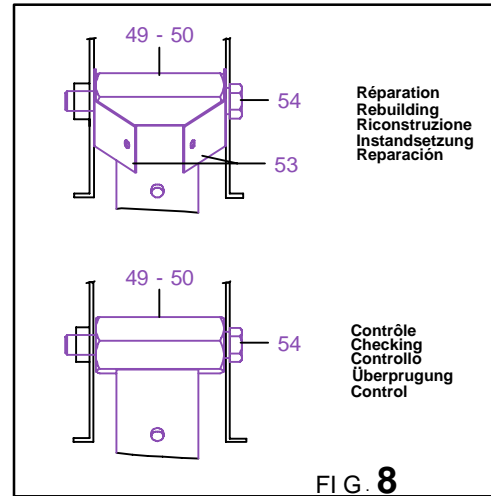
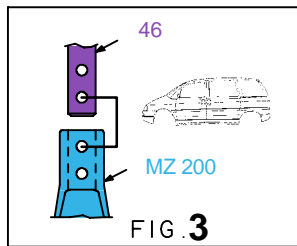
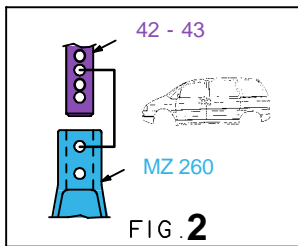
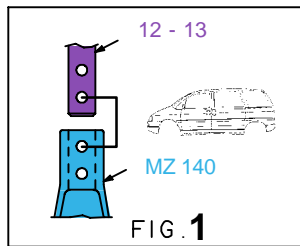
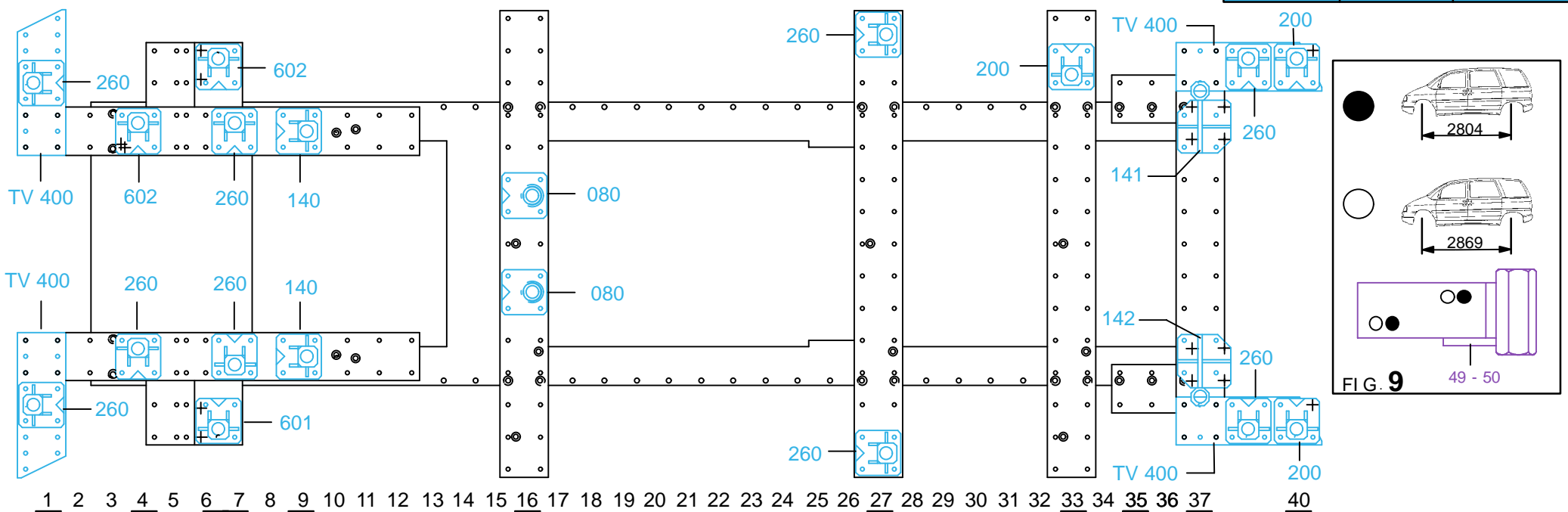

899.300-RVA3-1 00

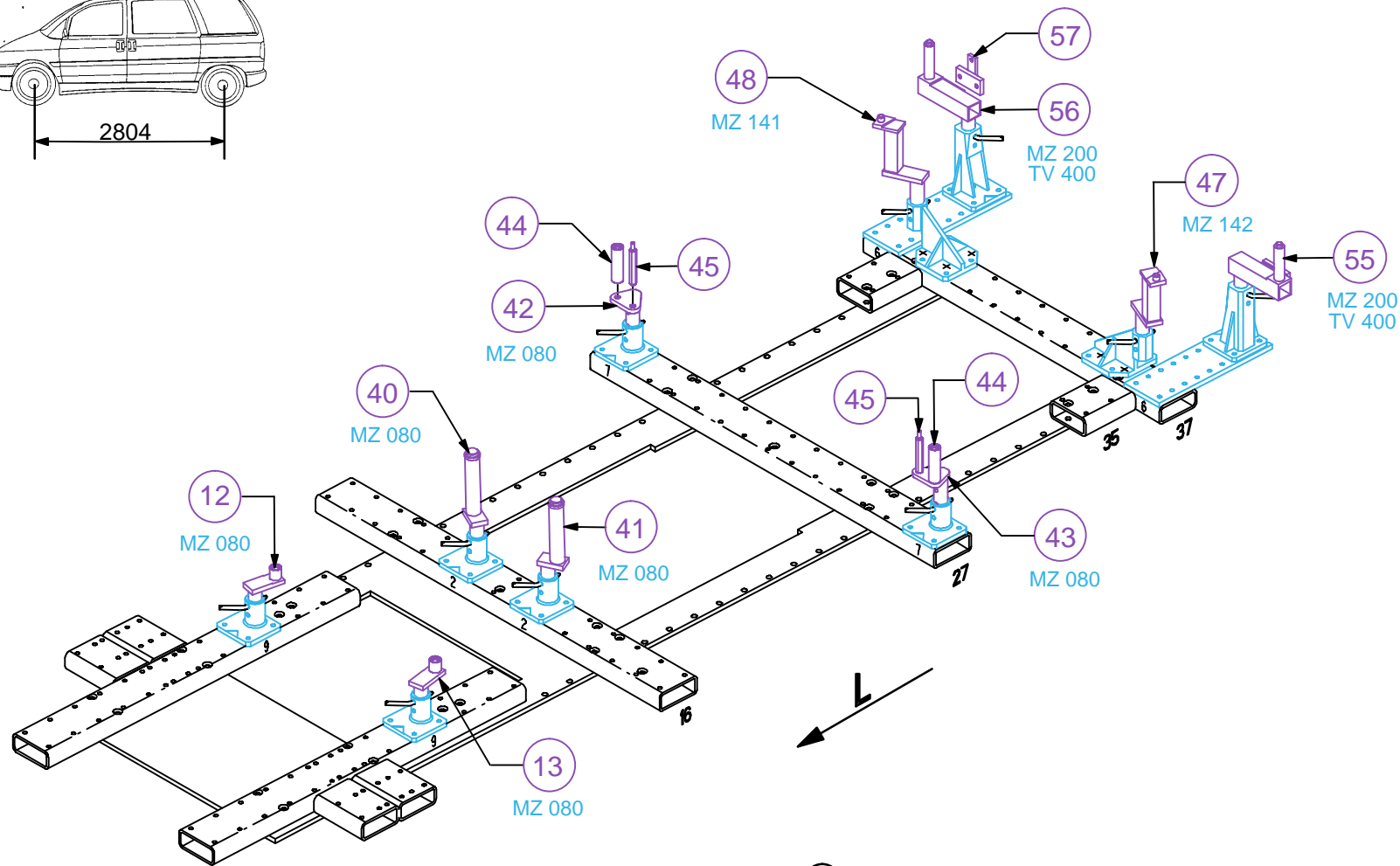
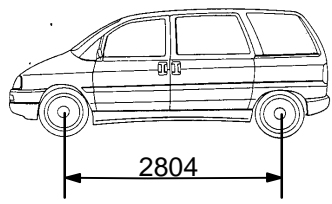

○ Avec ou sans mécanique  
 With or without mechanical elements  
 Con o senza parti meccaniche  
 Mit oder ohne Aggregate  
 Con ó sin mecánica desmontada

**RENAULT**

**899.300**

83 Kg | 12.04.2002 | 427-D-29H

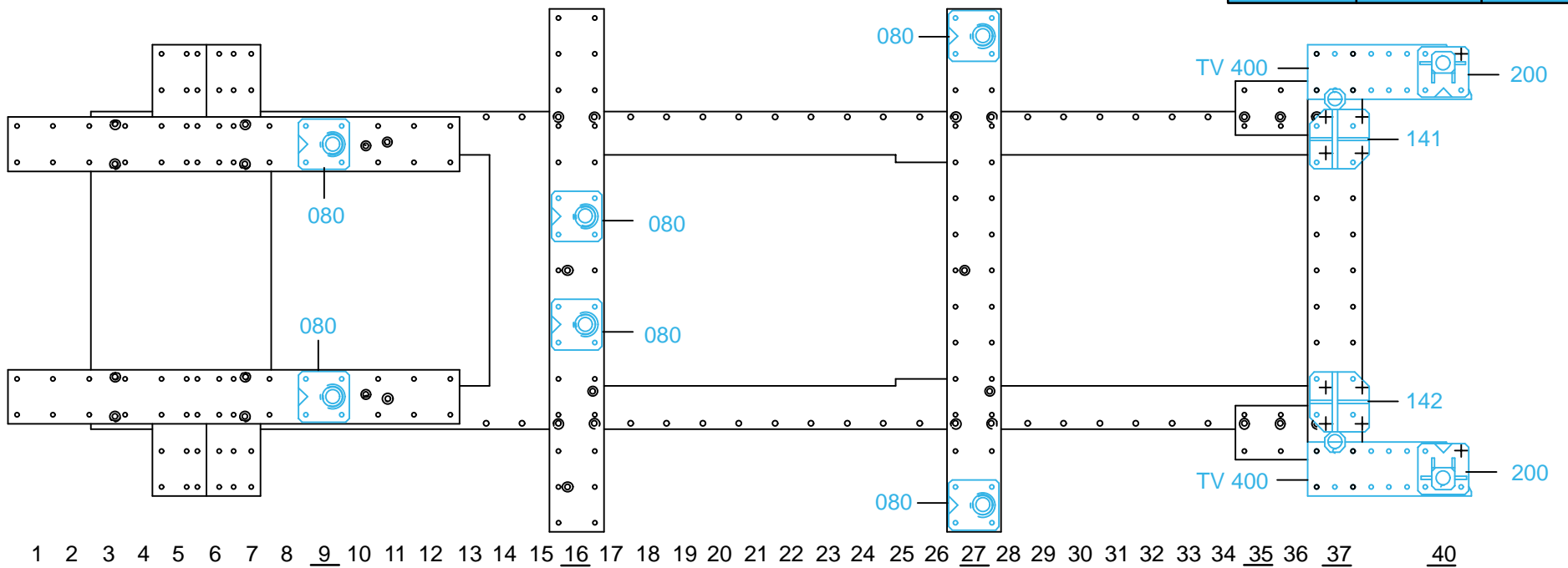

1 2 3 4 5 6 7 8 9 10 11 12 13 14 15 16 17 18 19 20 21 22 23 24 25 26 27 28 29 30 31 32 33 34 35 36 37 40

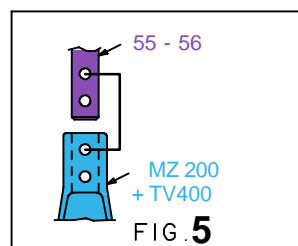
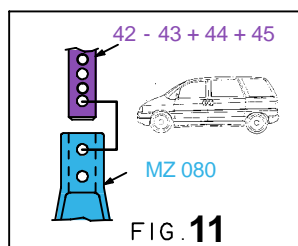
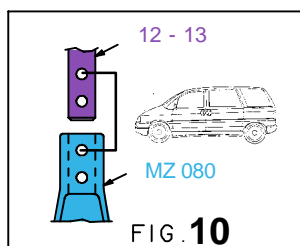



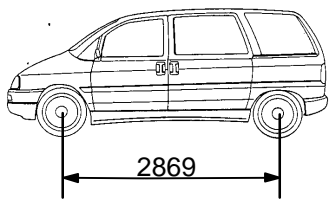

**M8S  
MT10  
SVN**

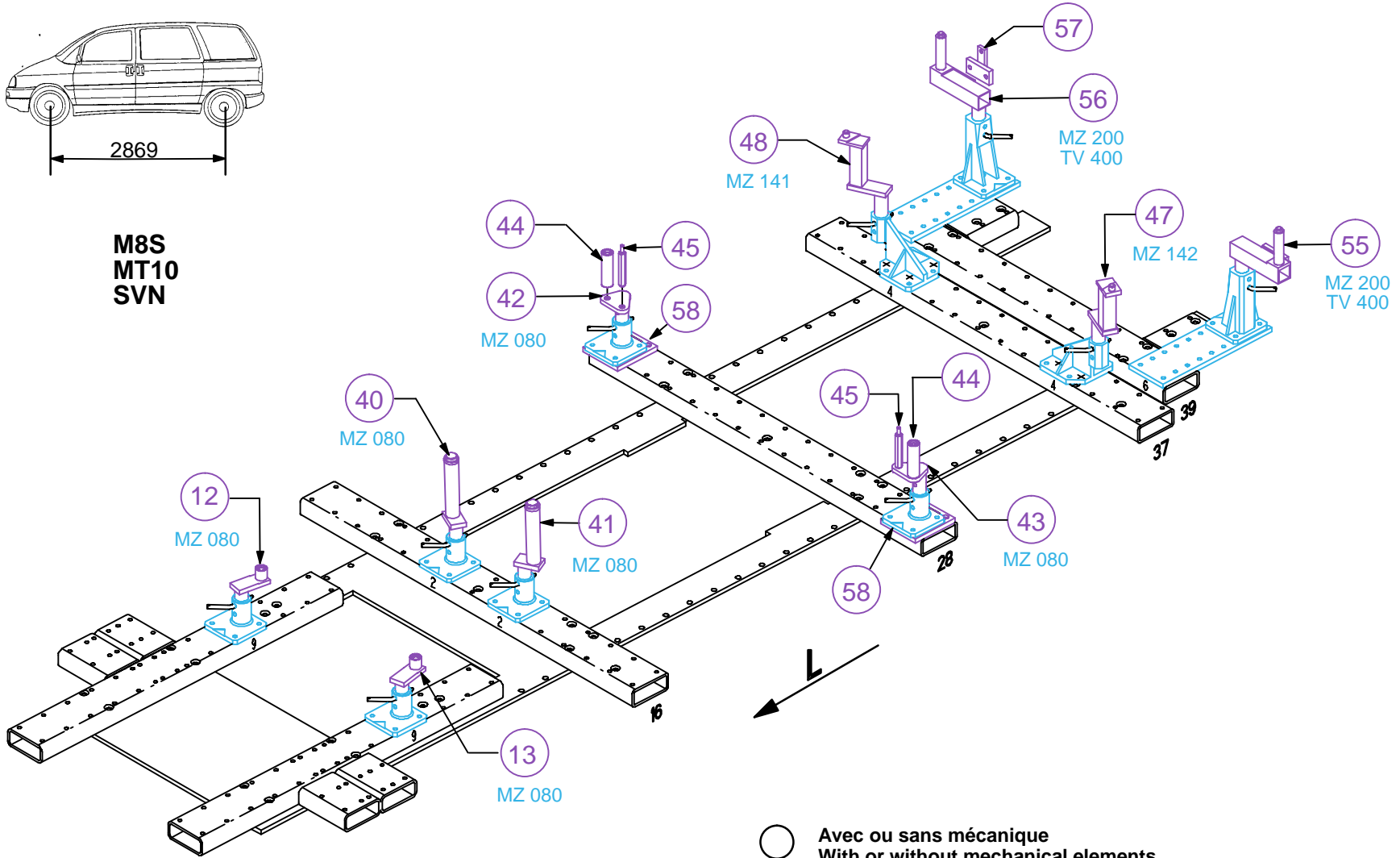

○ Avec ou sans mécanique  
With or without mechanical elements  
Con o senza parti meccaniche  
Mit oder ohne Aggregate  
Con ó sin mecánica desmontada

**RENAULT**

**899.300**

83 Kg | 12.04.2002 | 427-D-29L

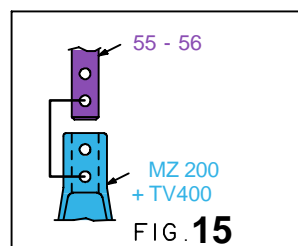
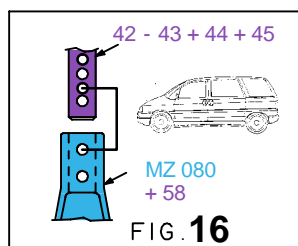
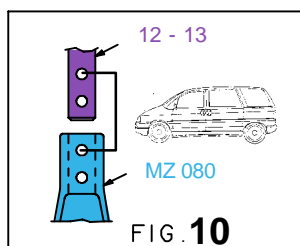
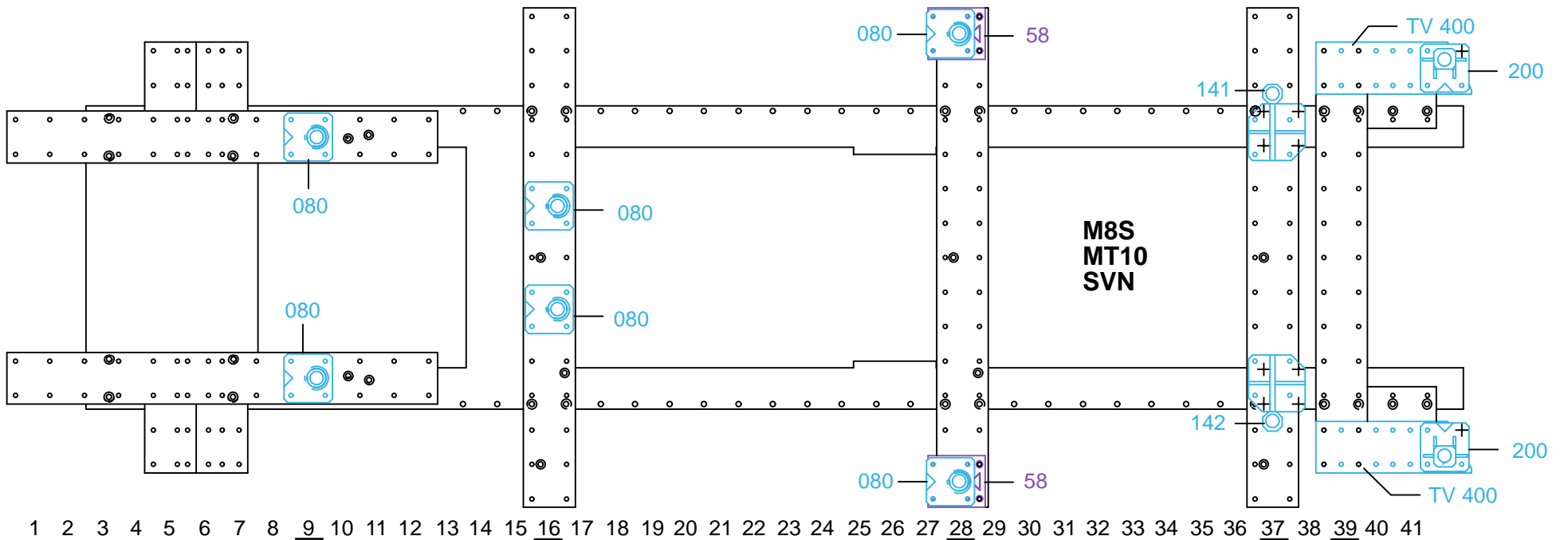

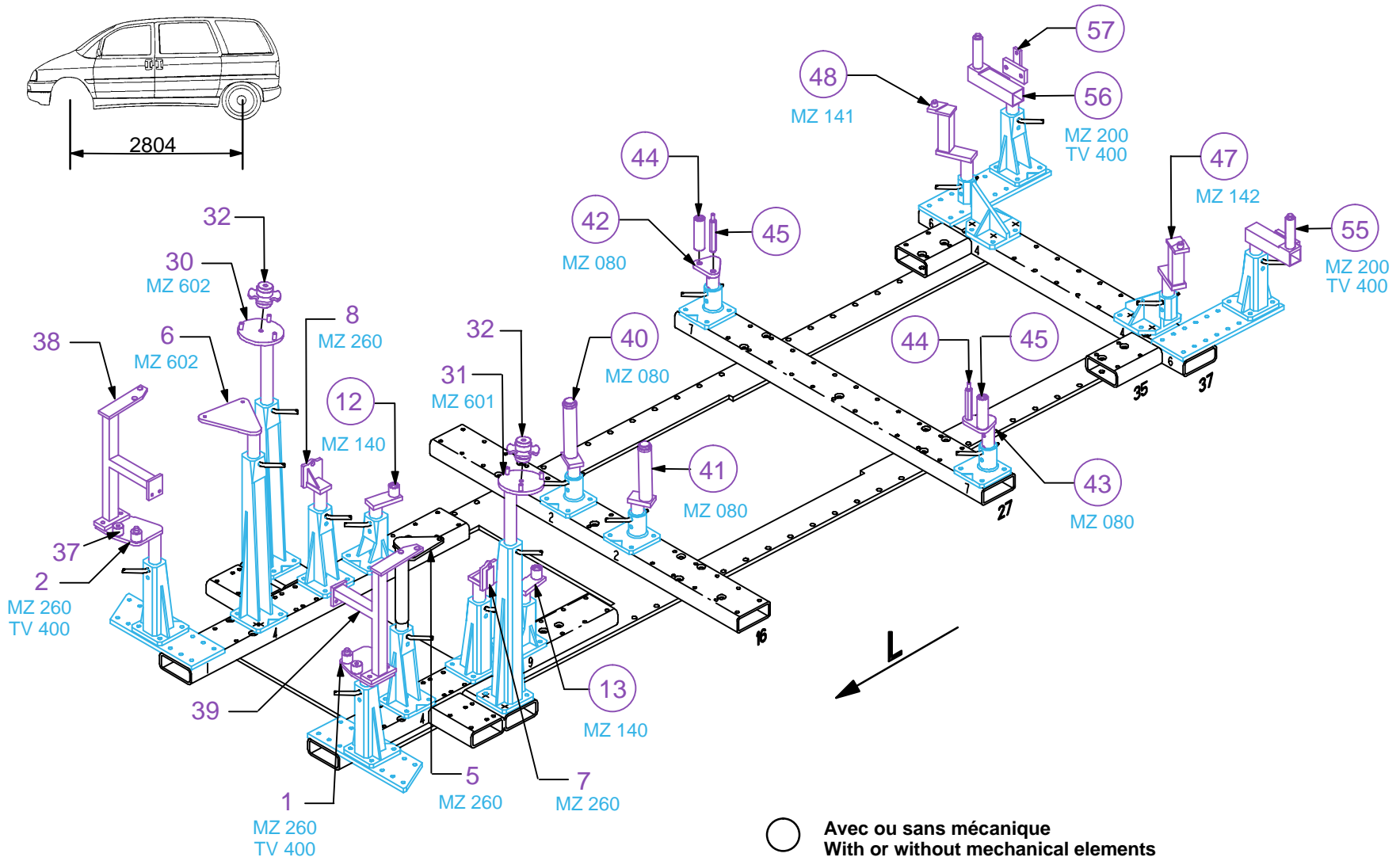

○ Avec ou sans mécanique  
 With or without mechanical elements  
 Con o senza parti meccaniche  
 Mit oder ohne Aggregate  
 Con ó sin mecanica desmontada

**RENAULT**

**899.300**

83 Kg | 12.04.2002 | 427-D-29M

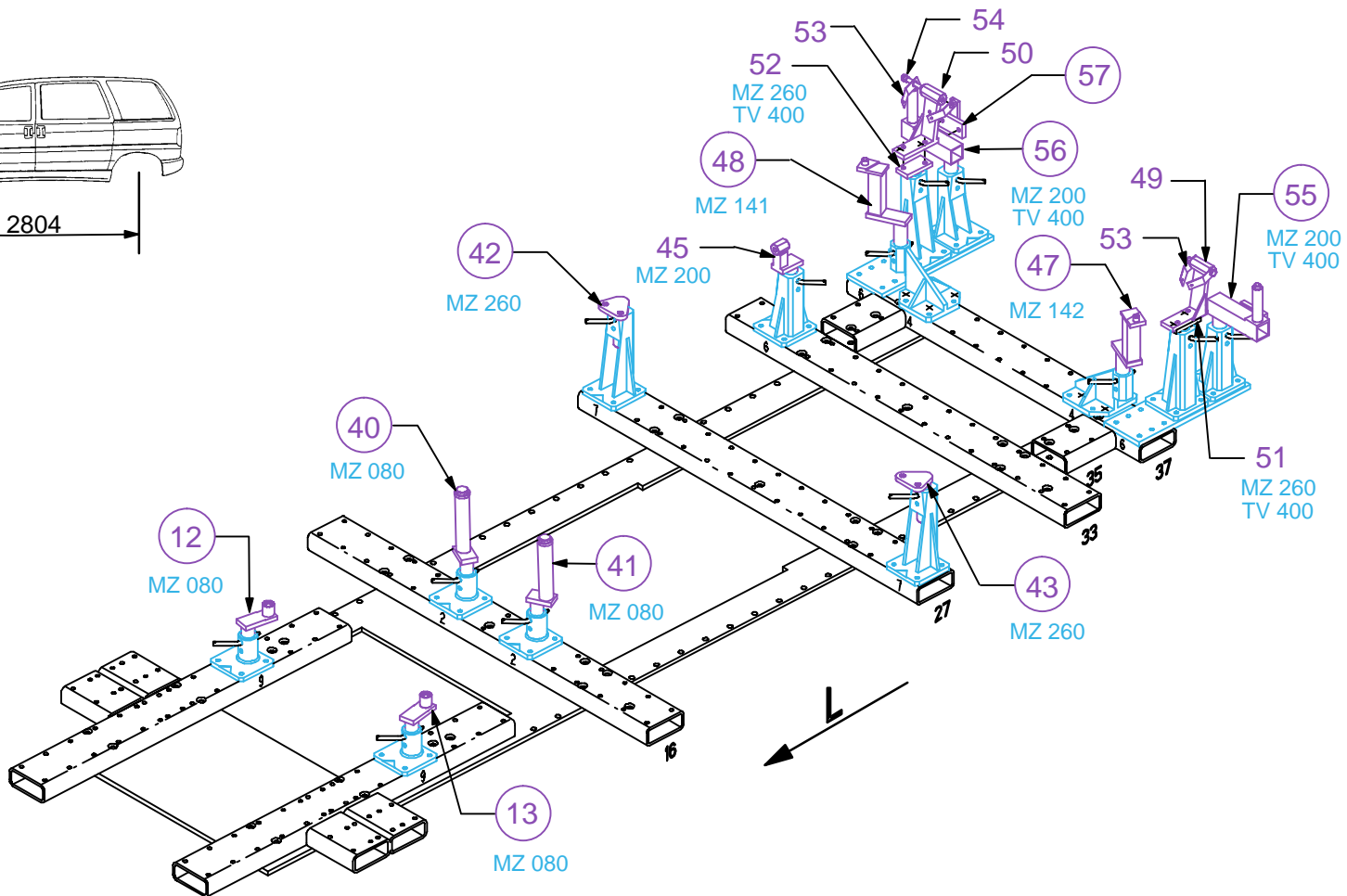
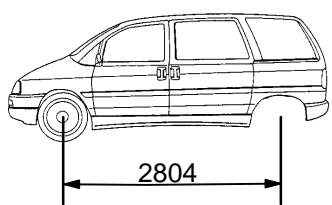

899.300-RVA3-3 | 00

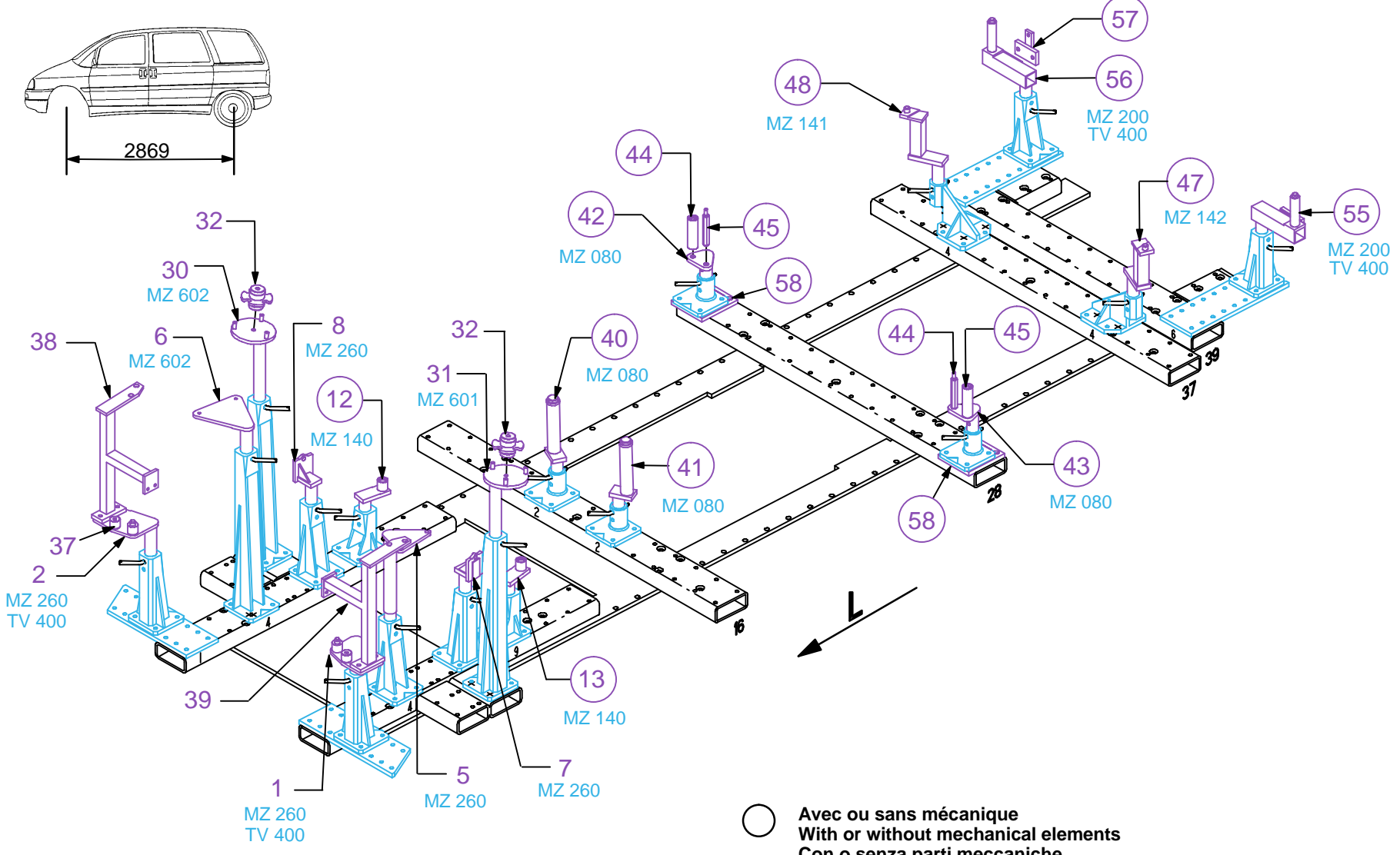

○ Avec ou sans mécanique  
 With or without mechanical elements  
 Con o senza parti meccaniche  
 Mit oder ohne Aggregate  
 Con ó sin mecánica desmontada

**RENAULT**

**899.300**

83 Kg    12.04.2002    427-D-29N

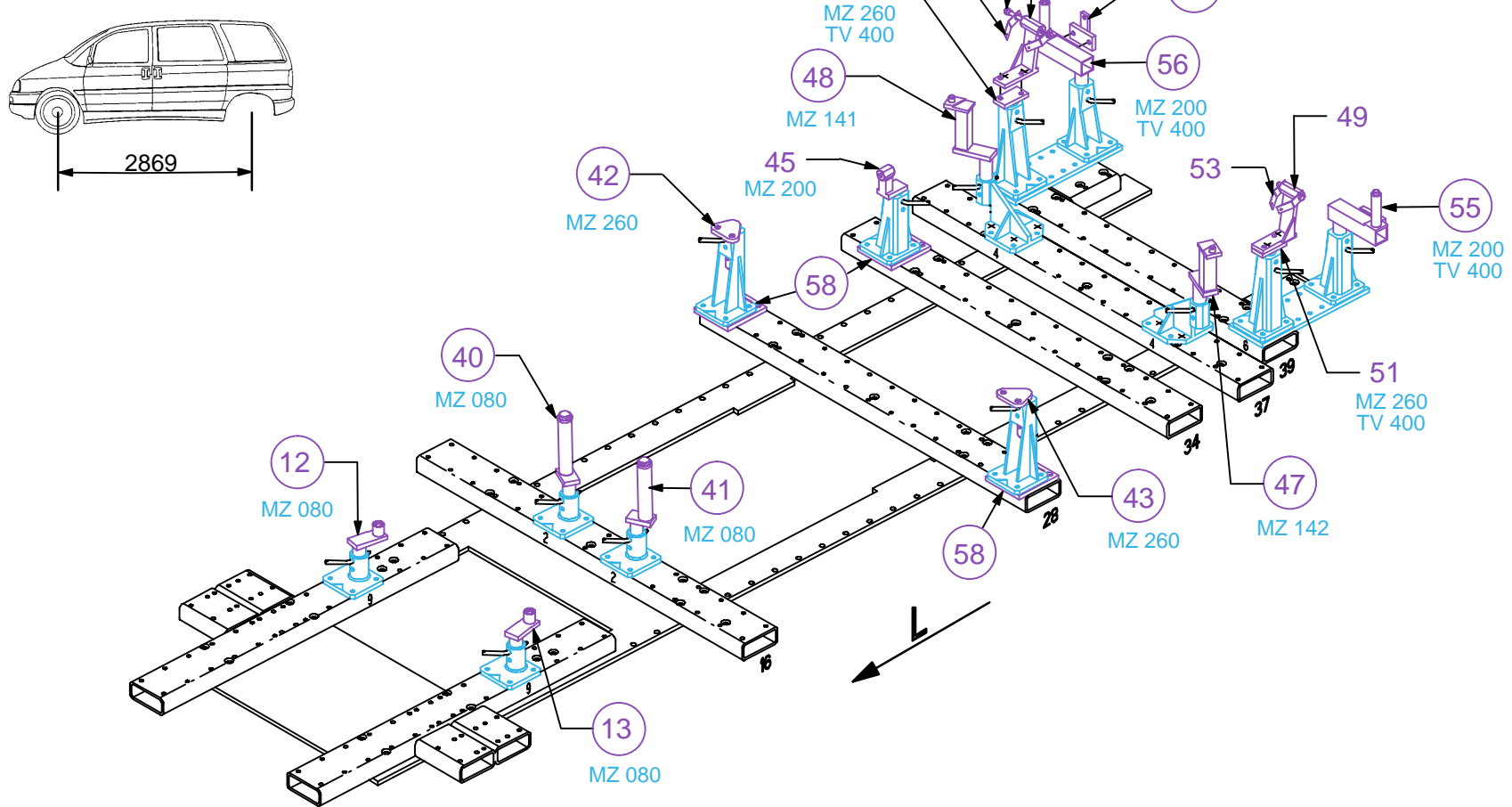

L

899.300-RVA3-3 00