

○ Avec ou sans mécanique  
 With or without mechanical elements  
 Con o senza parti meccaniche  
 Mit oder ohne Aggregate  
 Con ó sin mecanica desmontada

REP.	REFERENCE	PDS	NB	MZ
47	897.7047	2,1	1	260
48	897.7048	2,1	1	260

complément au  
 complementary set to  
 complemento al  
 zusatz zu

**897.300**  
 +  
**897.309**

**897.308**

4,2 Kg | 20.10.2003 | 422-D-24E

**OPEL**

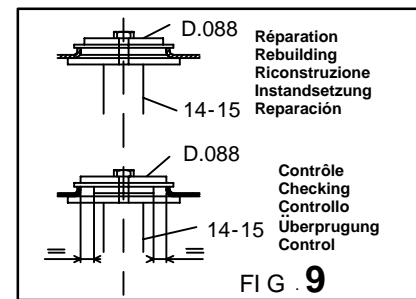
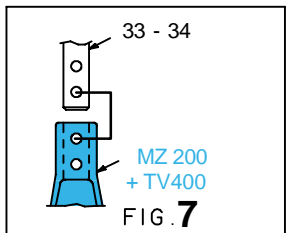
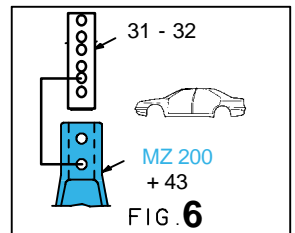
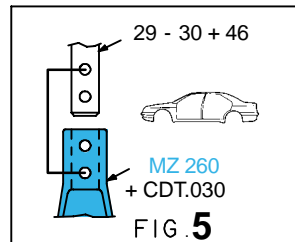
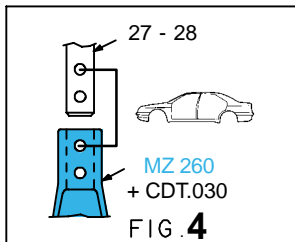
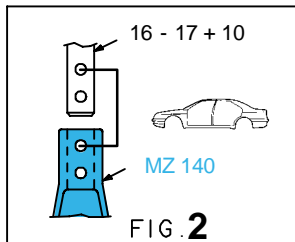
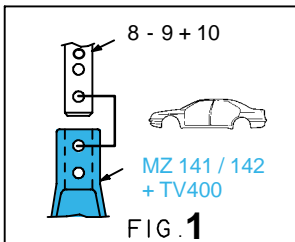
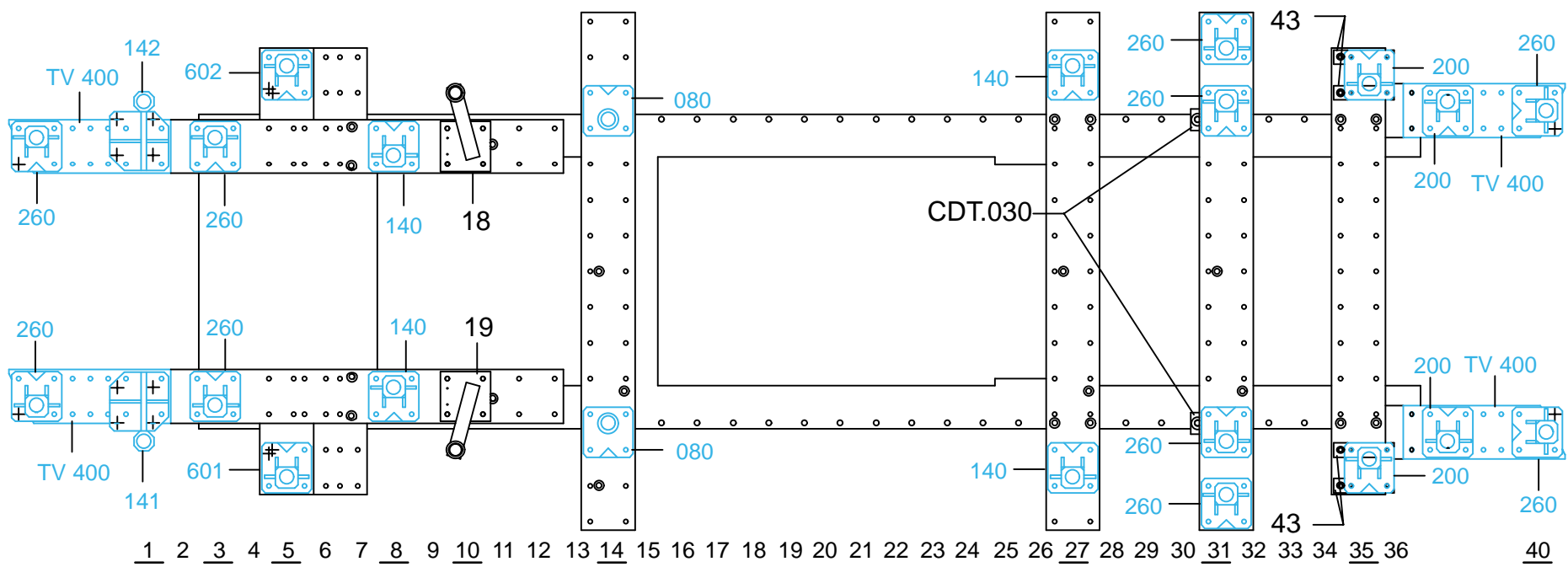

897.308-RVA3-1 | 00

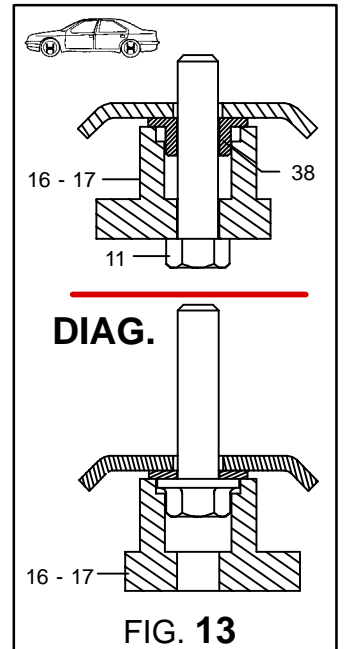
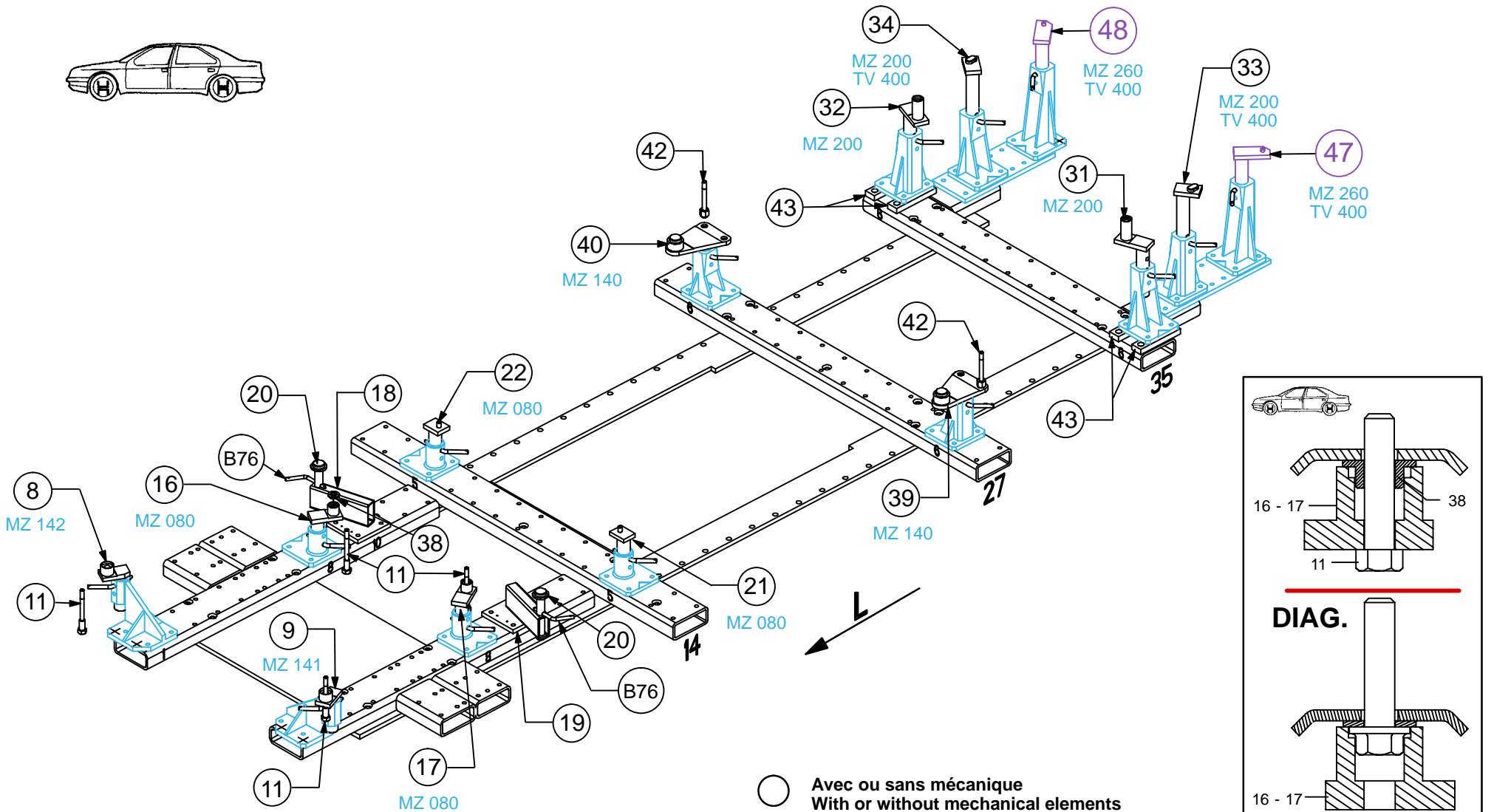

**OPEL**

**897.308**

4,2 Kg | 12.01.2005 | 422-D-24F

