

○ Avec ou sans mécanique  
 With or without mechanical elements  
 Con o senza parti meccaniche  
 Mit oder ohne Aggregate  
 Con ó sin mecanica desmontada

REP.	REFERENCE	PDS	NB	MZ
27	896.7027	3,6	1	
28	896.7028	3,6	1	
29	896.7029	3,7	1	601
30	896.7030	3,7	1	602
31	896.7031	0,1	4	
32	896.7032	2,4	1	200
33	896.7033	2,4	1	200
34	896.7034	2,4	1	260
35	896.7035	2,4	1	260
36	896.7036	2,9	1	200
37	896.7037	3,3	1	200
38	896.7038	3,3	1	260
39	896.7039	3,3	1	260
40	896.7040	5,7	2	

M 10-70	4
M 8	4

complément au  
 complementary set to  
 complemento al  
 zusatz zu **896.300**

**896.309**

49 Kg | 10.03.2003 | 427-D-30C

**RENAULT**

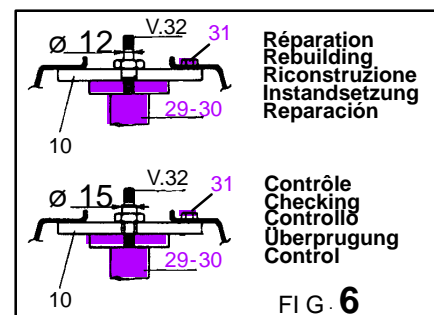
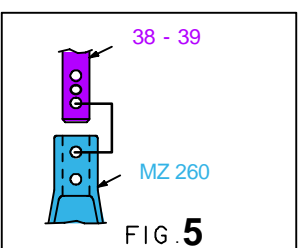
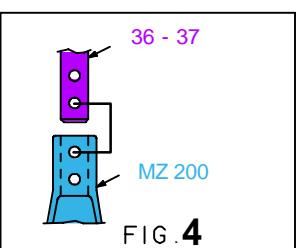
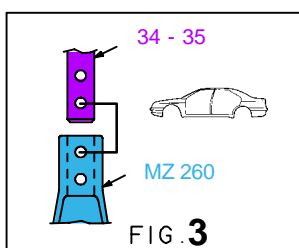
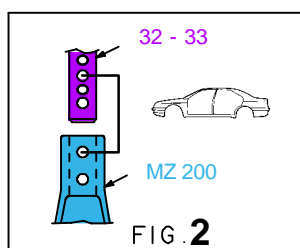
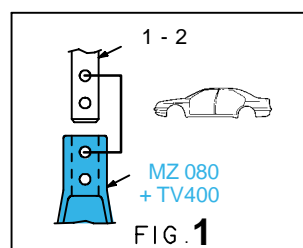
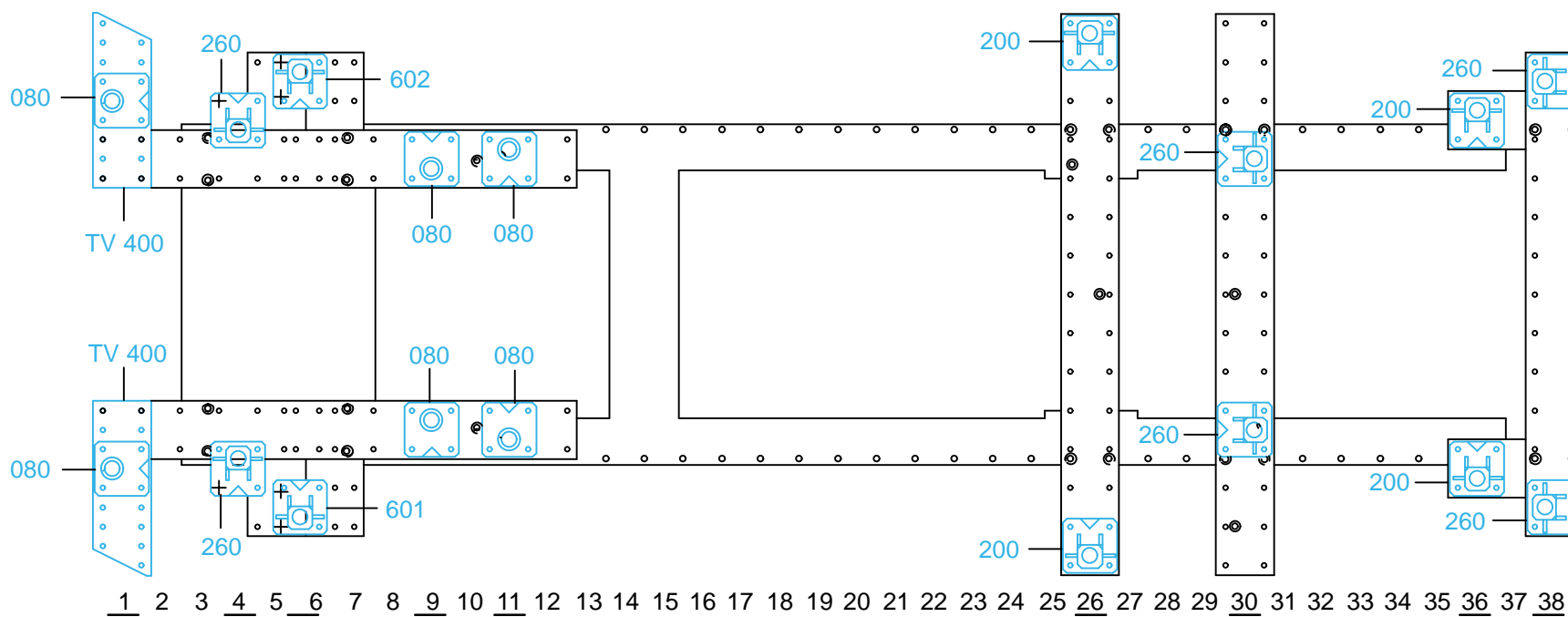

896.309-RVA3-1 | 00

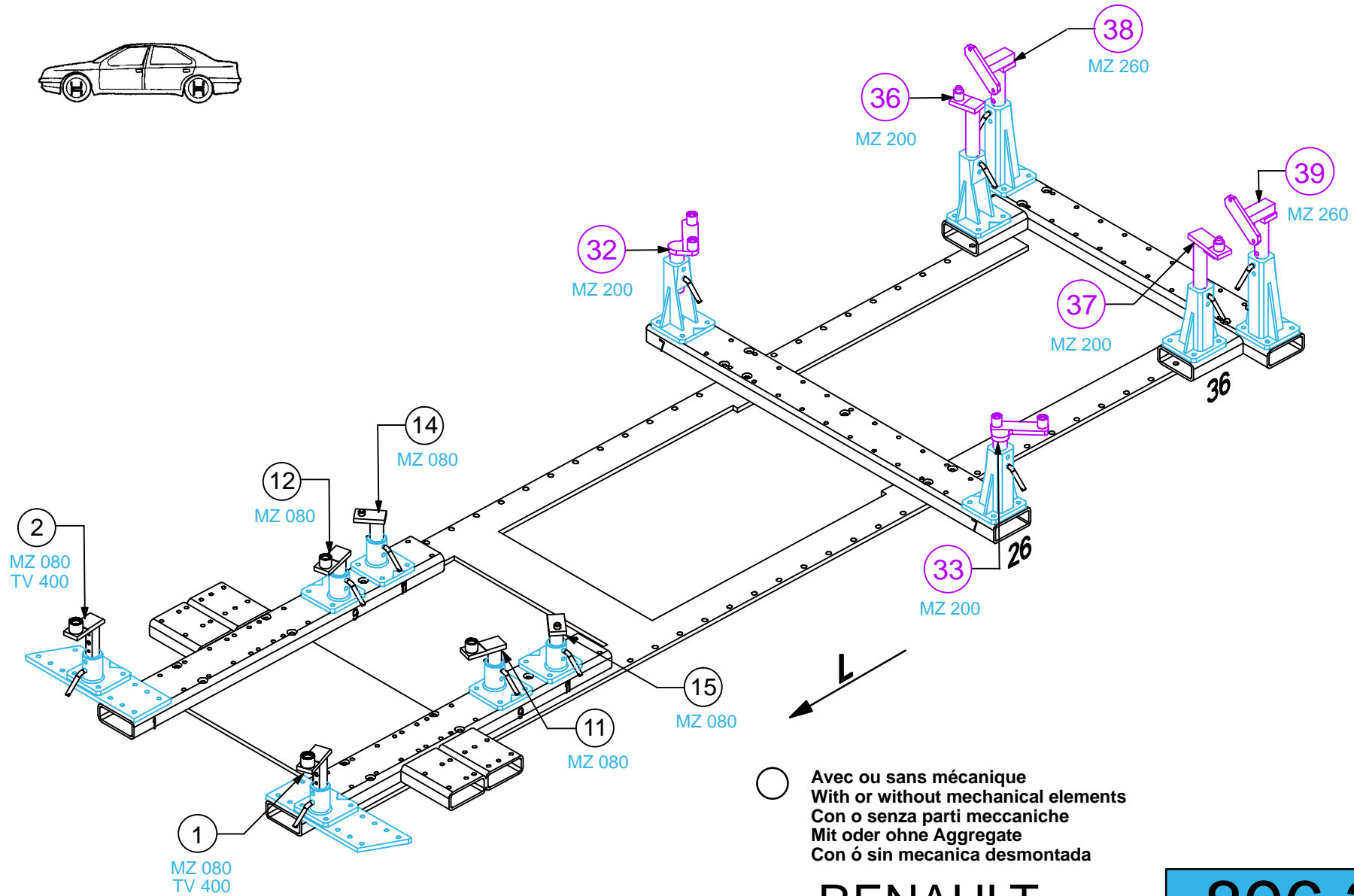
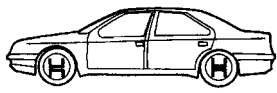

**RENAULT**

**896.309**

49 Kg | 10.03.2003 | 427-D-30D

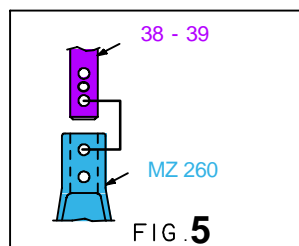
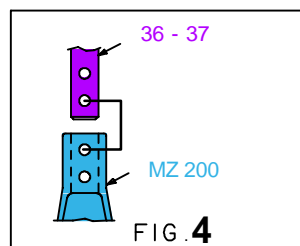
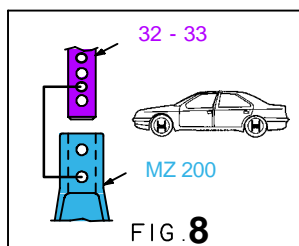
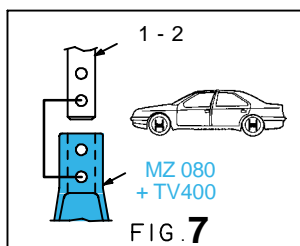
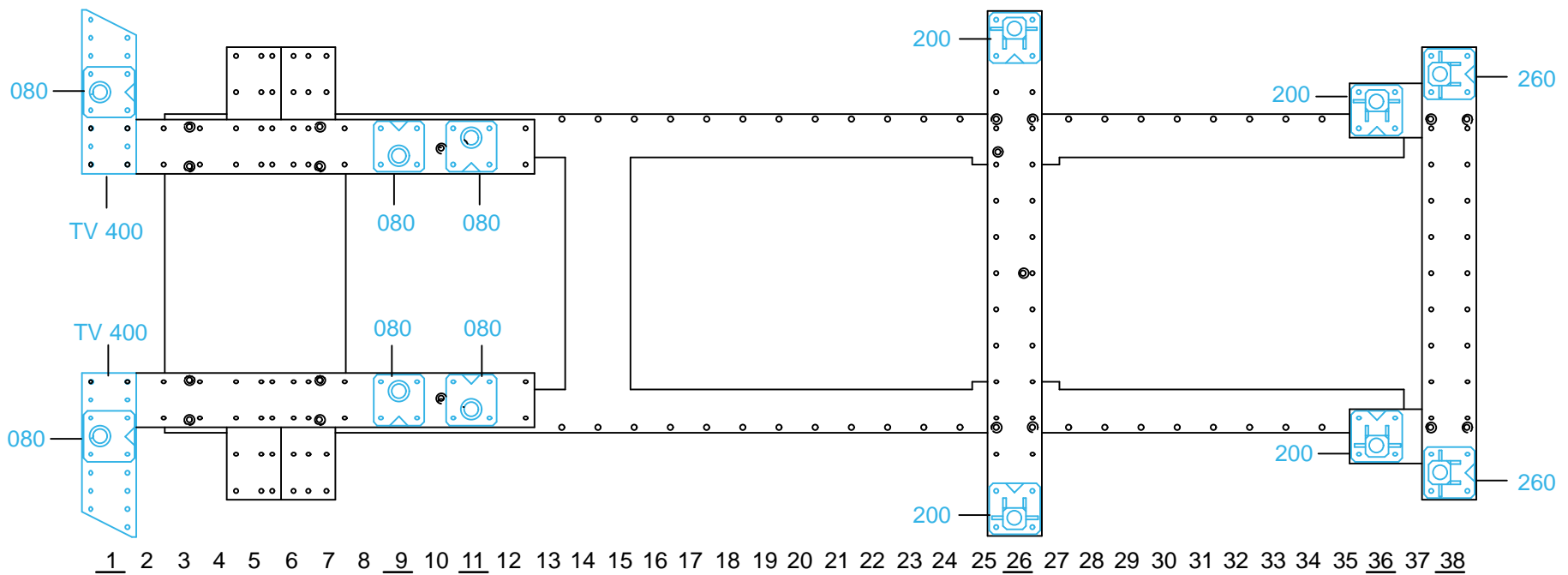

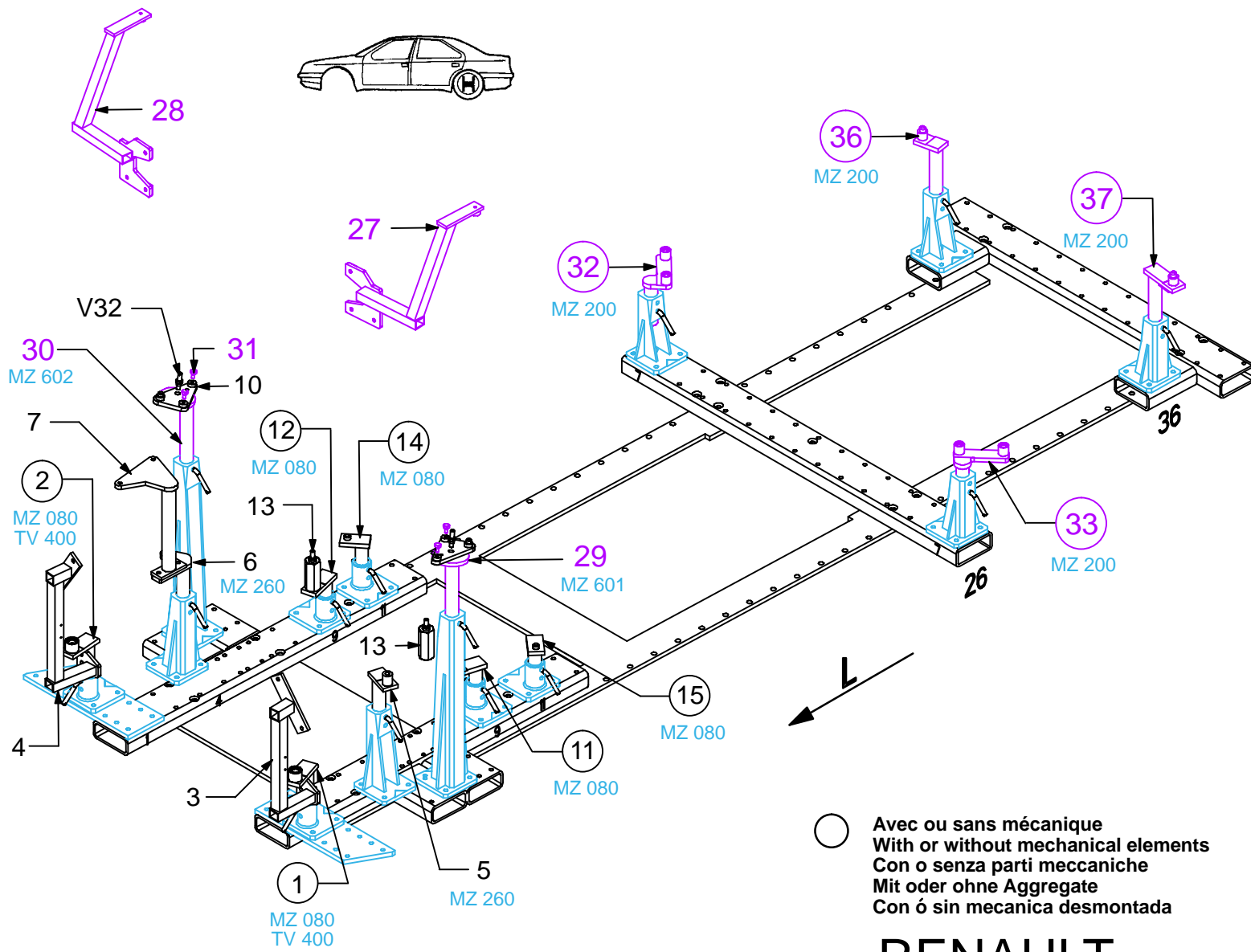

○ Avec ou sans mécanique  
 With or without mechanical elements  
 Con o senza parti meccaniche  
 Mit oder ohne Aggregate  
 Con ó sin mecanica desmontada

**RENAULT**

**896.309**

49 Kg | 10.03.2003 | 427-D-30E

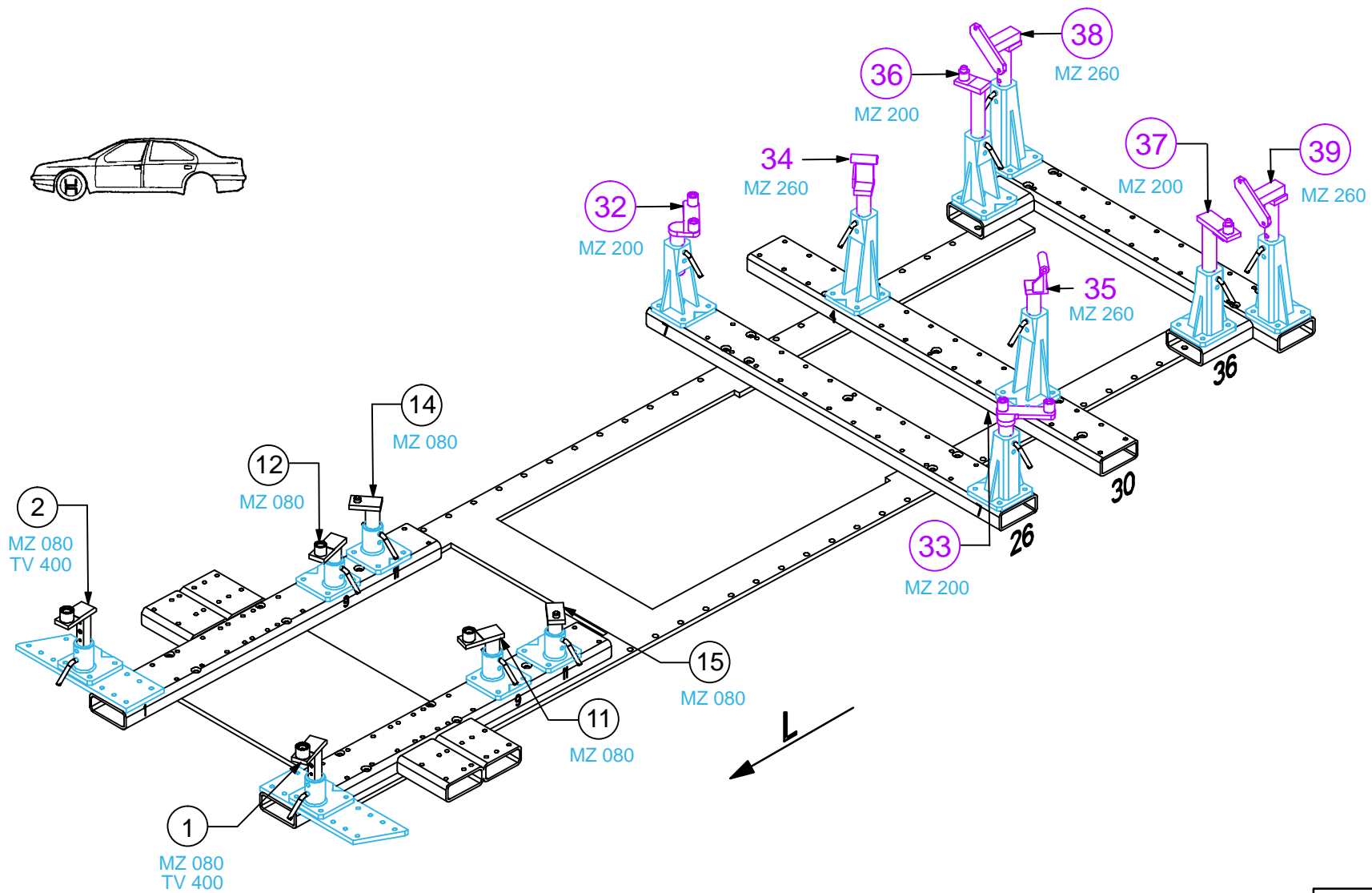

896.309-RVA3-3 | 00

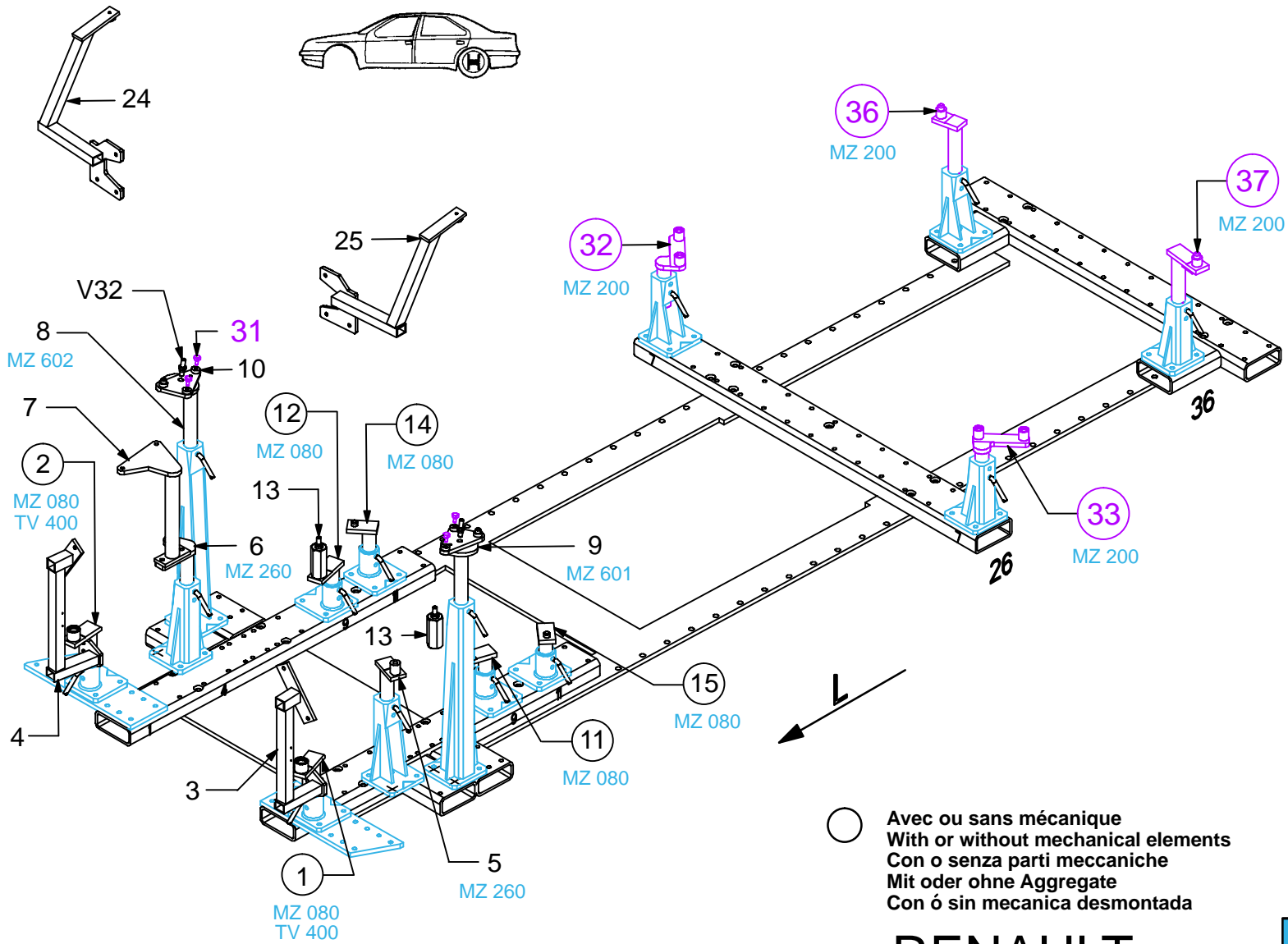

○ Avec ou sans mécanique  
With or without mechanical elements  
Con o senza parti meccaniche  
Mit oder ohne Aggregate  
Con ó sin mecanica desmontada

**RENAULT**

**896.309**

49 Kg | 10.03.2003 | 427-D-30H

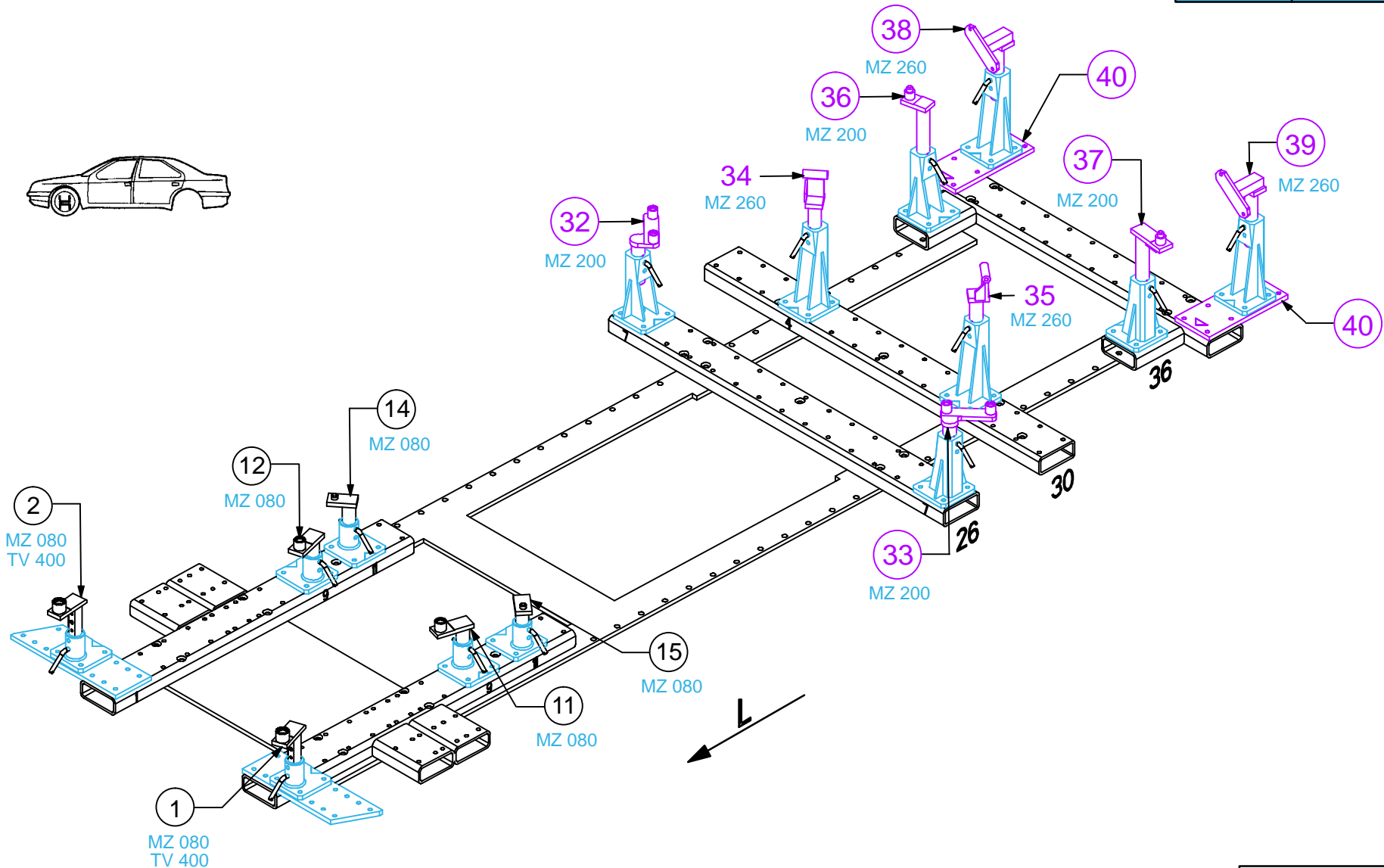

896.309-RVA3-3 | 00



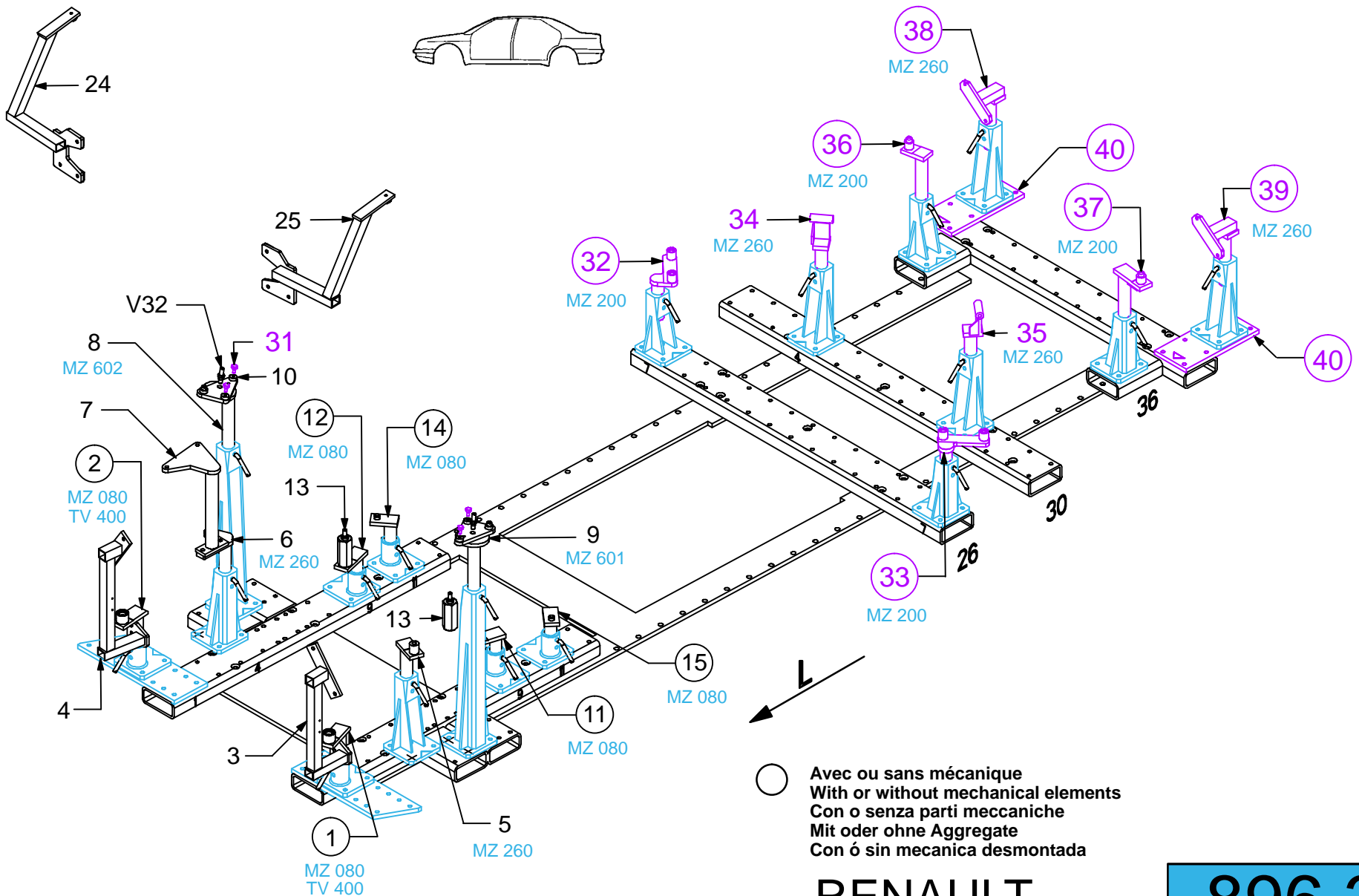

**RENAULT**

**896.309**

49 Kg    10.03.2003    427-D-30F

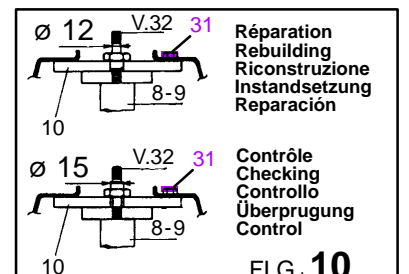
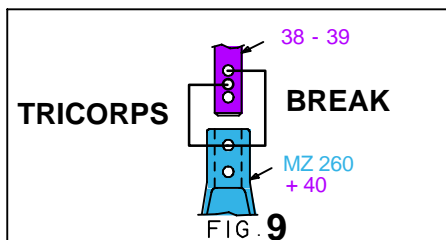
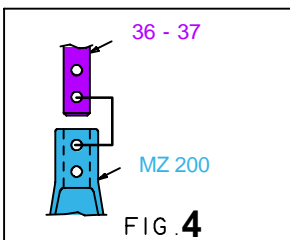
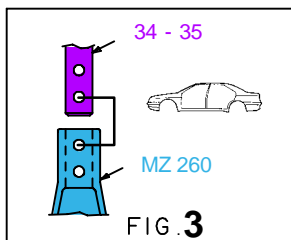
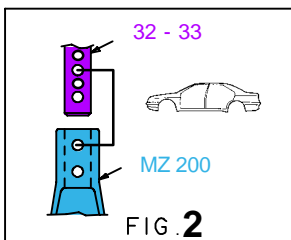
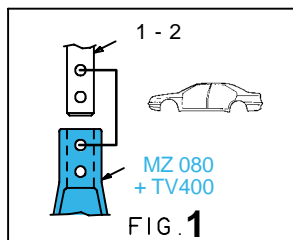
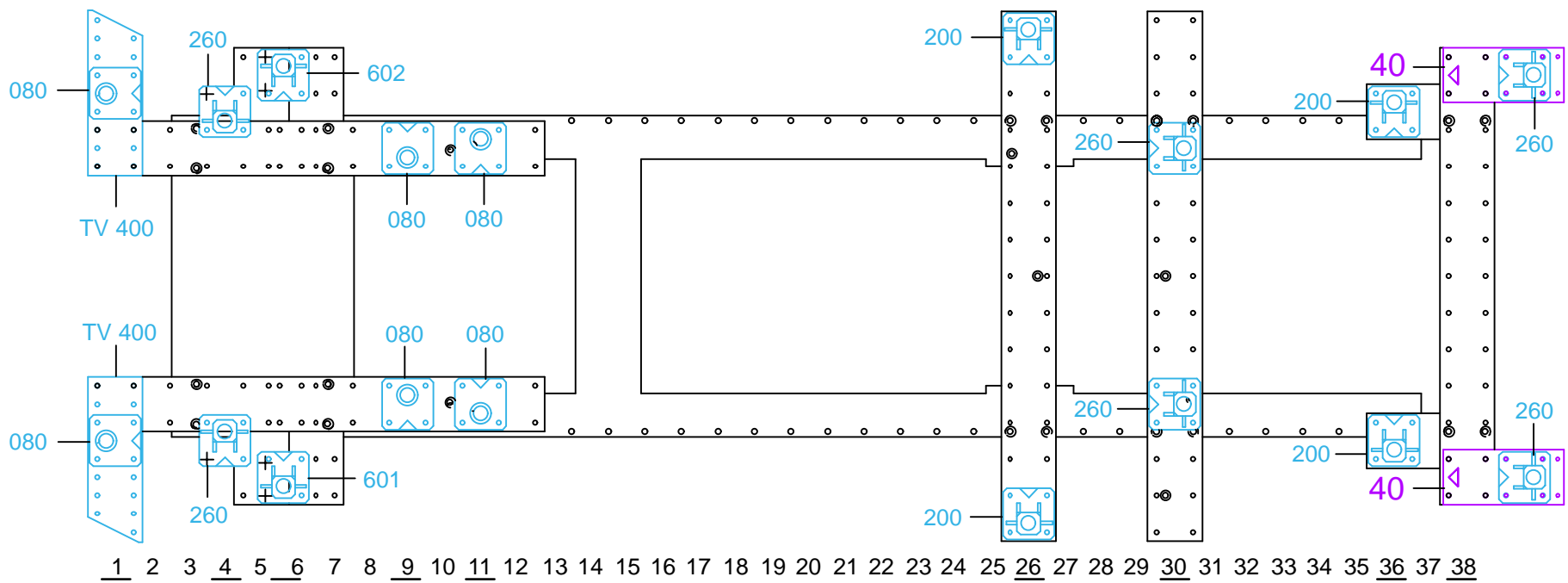

896.309-RVA3-2    00

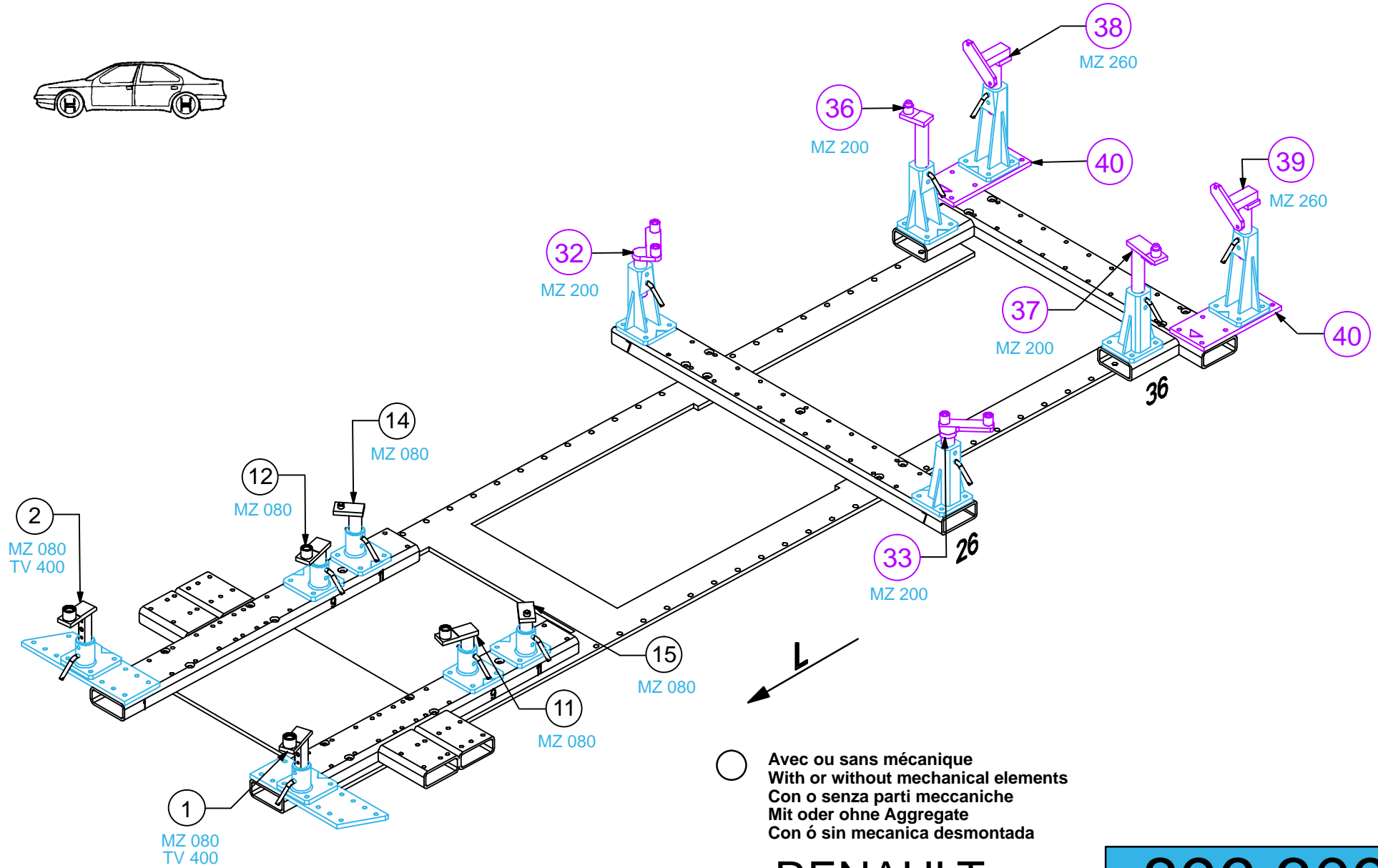

**RENAULT**

**896.309**

49 Kg | 10.03.2003 | 427-D-30G

