

ANCRAGE DU VEHICULE
ANCHORING OF THE VEHICLE
VERANKERUNG DES FAHRZEUGS
ANCORAGGIO DEL VEICOLO
ANCLAJE DEL VEHICULO

AN.27.B + AN27.03

Ou/Or/Oder/O

AN.34

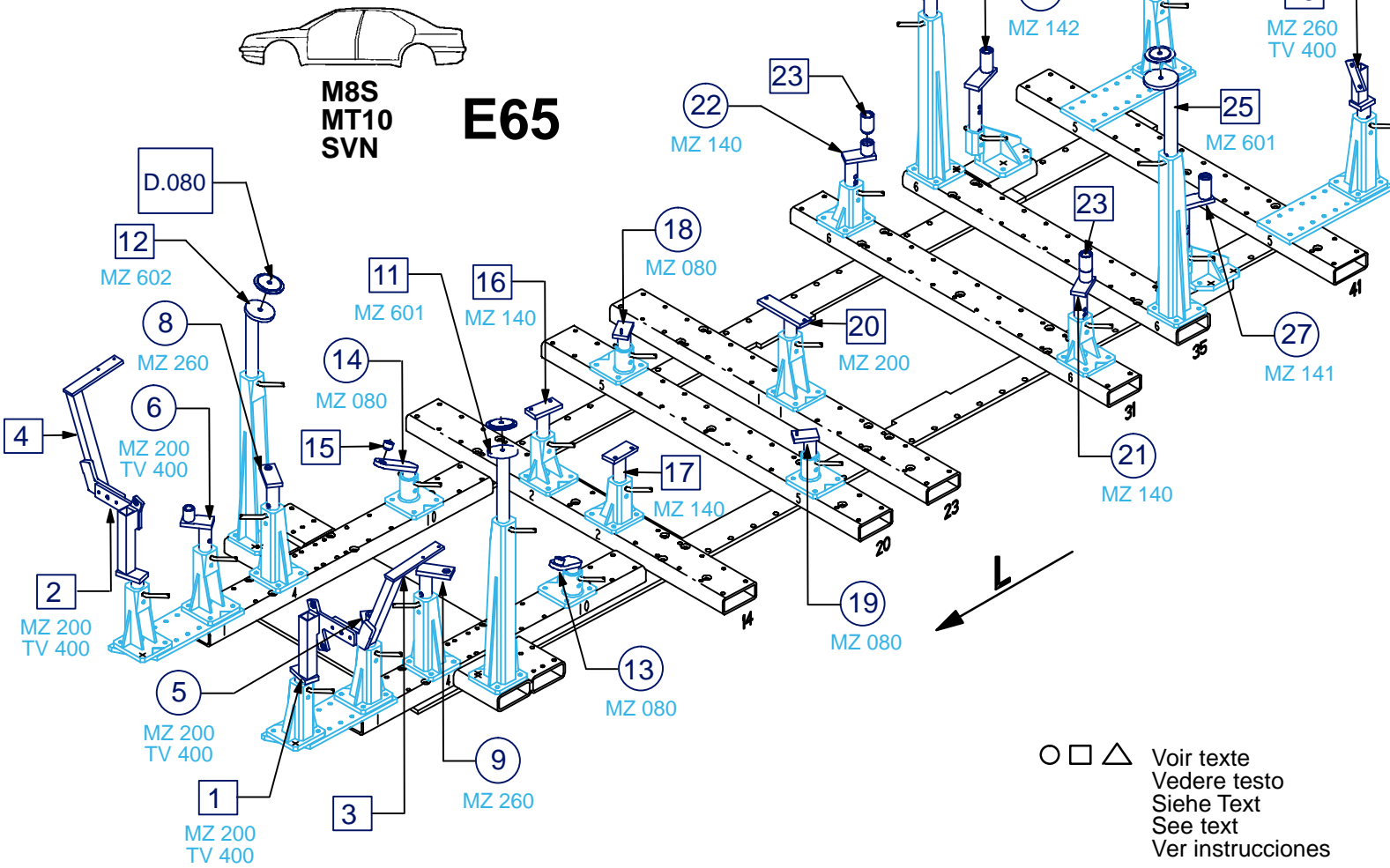

REP.	REFERENCE	PDS	NB	MZ
1	880.7001	3,8	1	200
2	880.7002	3,8	1	200
3	880.7003	2,9	1	
4	880.7004	2,9	1	
5	880.7005	2,2	1	200/140
6	880.7006	2,2	1	200/140
7	880.7007	0,5	2	
8	880.7008	1,9	1	260/080
9	880.7009	1,9	1	260/080
10	880.7010	0,9	2	
11	880.7011	2,0	1	601
12	880.7012	2,0	1	602
13	880.7013	1,7	1	080
14	880.7014	1,7	1	080
15	880.7015	0,08	2	
16	880.7016	2,1	1	140
17	880.7017	2,1	1	140
18	880.7018	1,6	1	080
19	880.7019	1,6	1	080
20	880.7020	2,2	1	200
21	880.7021	2,2	1	140
22	880.7022	2,2	1	140
23	880.7023	0,4	2	
24	880.7024	2,4	1	602
25	880.7025	2,4	1	601
26	880.7026	3,3	1	142
27	880.7027	3,3	1	141
28	880.7028	2,1	1	260
29	880.7029	2,1	1	260
36	880.7036	1,0	1	
	CDT.040	1,5	6	
	D.070	0,4	2	
	D.080	0,5	2	

M 8-25	6
M 12-20	2
M 12-25	2
M 12-30	4
M 12-65	2
M 12x1,50-40	2
M 12x1,50-50	4
M 14x1,50-70	2
M 14x1,50-110	2
M 14x1,50-160	2
M 14x1,50-200	2
TFHc 16-60	12
955.714	12

M 8	4
M 10	4
MU 12	2

BMW

880.300

77 Kg 24.09.2001 406-D-19A

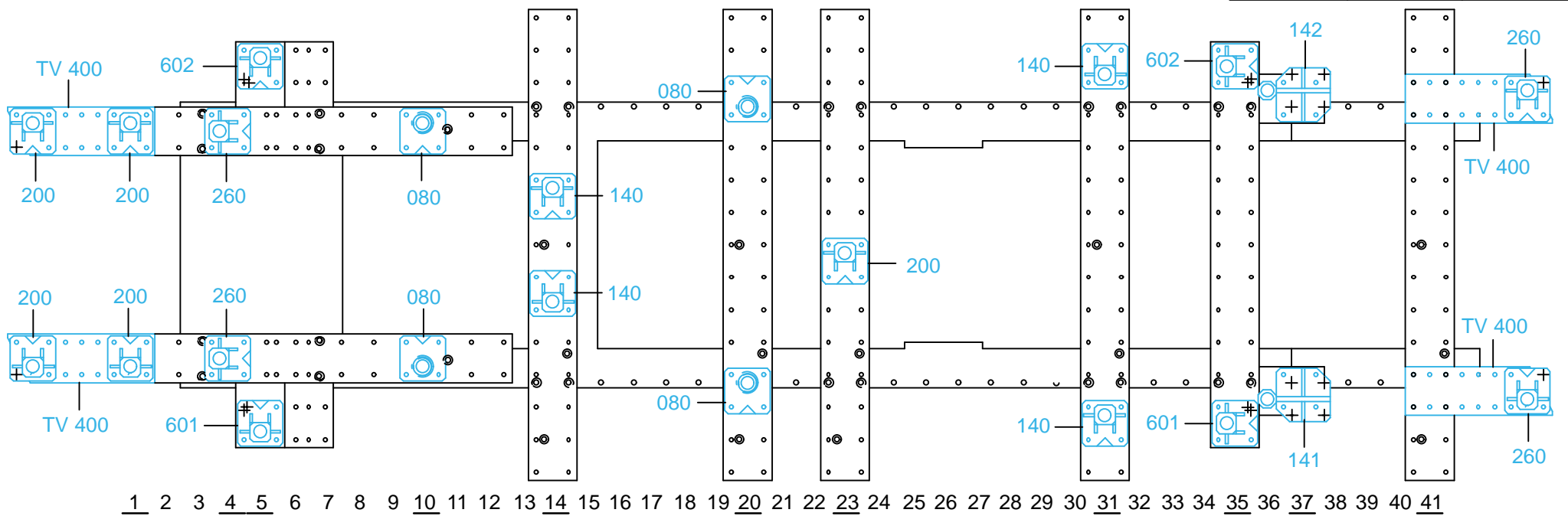

1 2 3 4 5 6 7 8 9 10 11 12 13 14 15 16 17 18 19 20 21 22 23 24 25 26 27 28 29 30 31 32 33 34 35 36 37 38 39 40 41

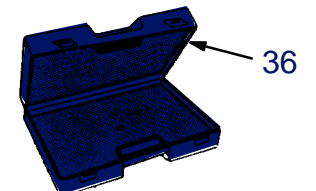
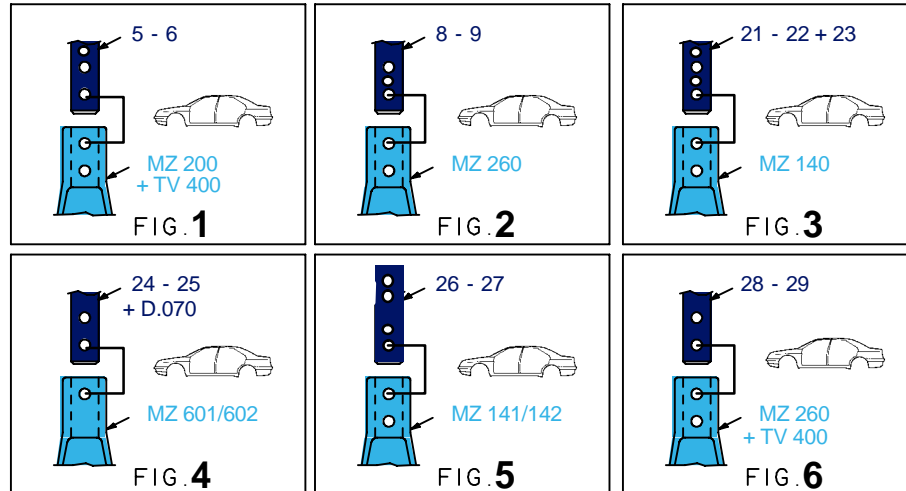
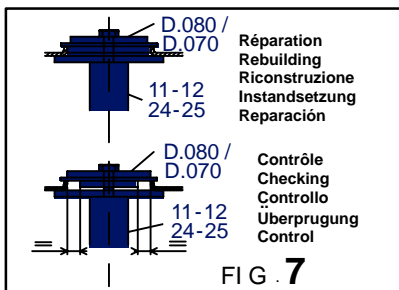

ANCRAGE DU VEHICULE
ANCHORING OF THE VEHICLE
VERANKERUNG DES FAHRZEUGS
ANCORAGGIO DEL VEICOLO
ANCLAJE DEL VEHICULO

AN.27.B + AN27.03

Ou/Or/Oder/O

AN.34

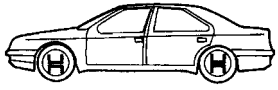

**M8S
MT10
SVN**

E65

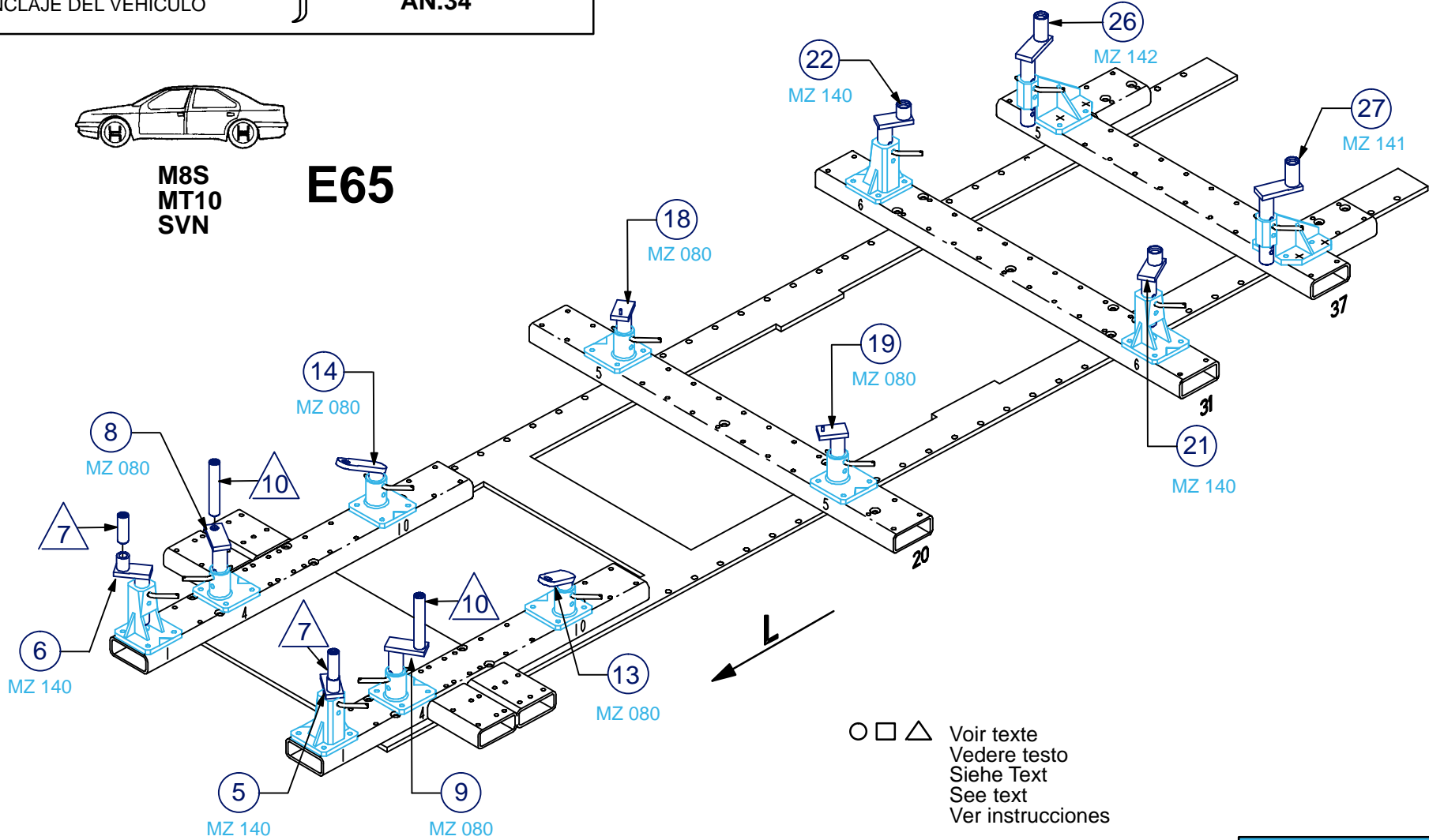

○ □ △ Voir texte
Vedere testo
Siehe Text
See text
Ver instrucciones

BMW

880.300

77 Kg

24.09.2001

406-D-19B

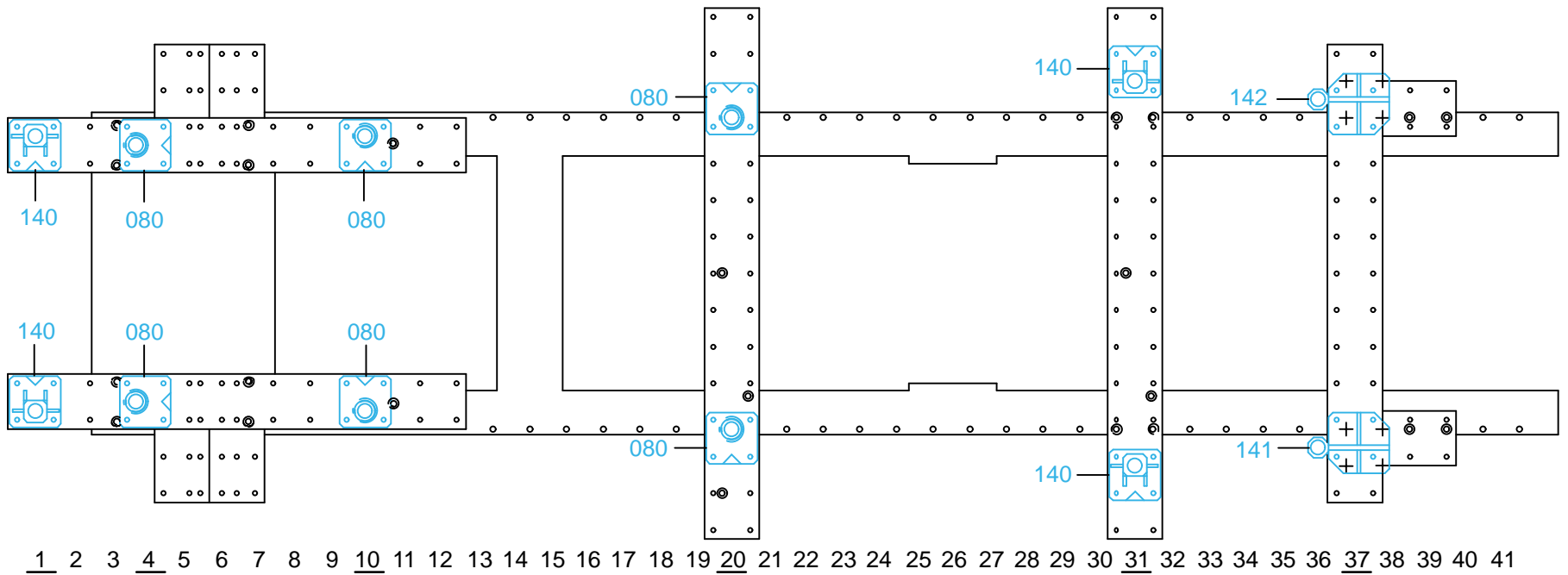

1 2 3 4 5 6 7 8 9 10 11 12 13 14 15 16 17 18 19 20 21 22 23 24 25 26 27 28 29 30 31 32 33 34 35 36 37 38 39 40 41

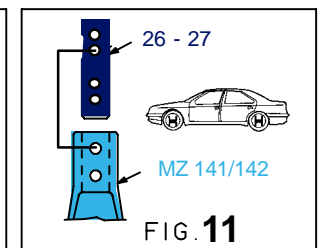
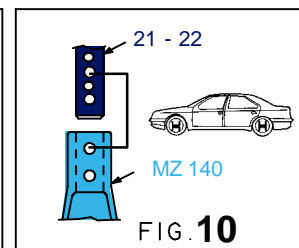
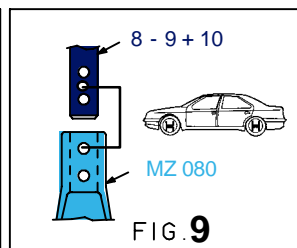
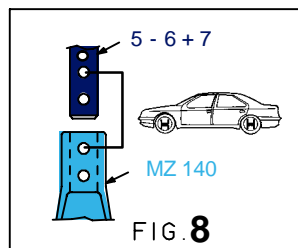
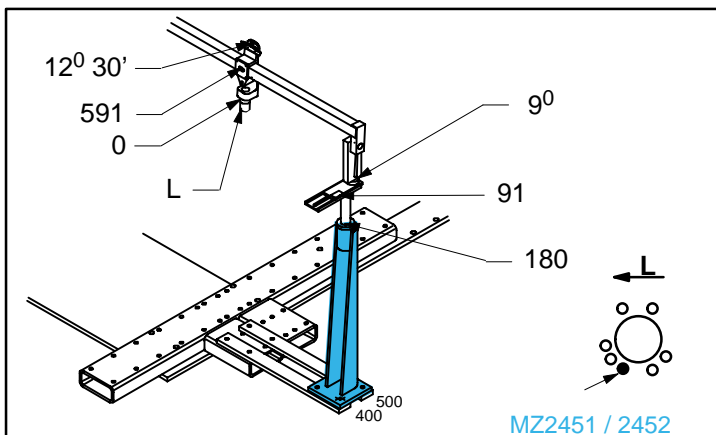

ANCRAGE DU VEHICULE
ANCHORING OF THE VEHICLE
VERANKERUNG DES FAHRZEUGS
ANCORAGGIO DEL VEICOLO
ANCLAJE DEL VEHICULO

AN.27.B + AN27.03
Ou/Or/Oder/O
AN.34



**M8S
MT10
SVN
E66**

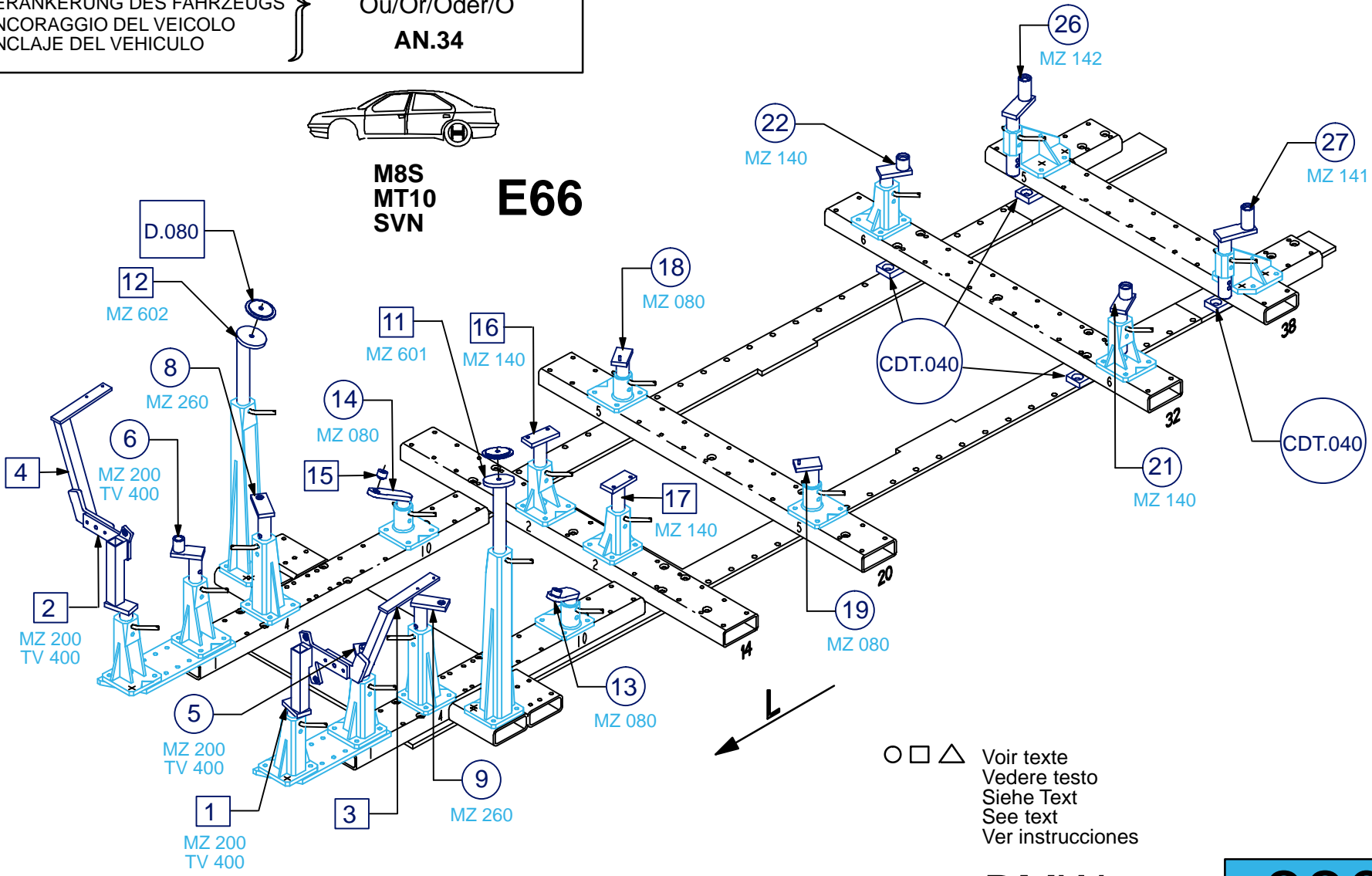

BMW

880.300

77 Kg 24.09.2001 406-D-19C

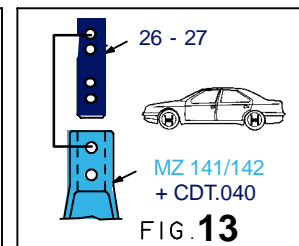
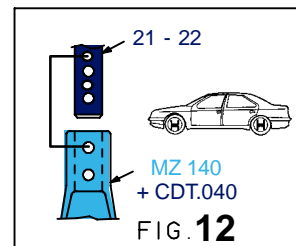
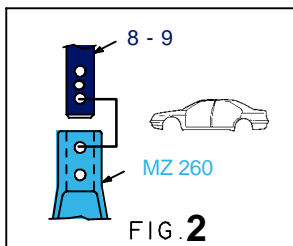
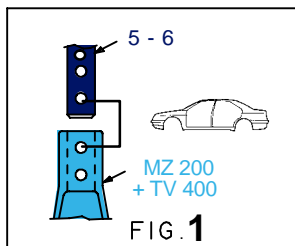
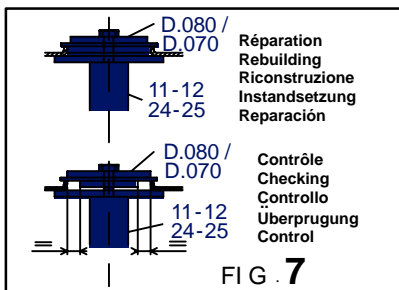
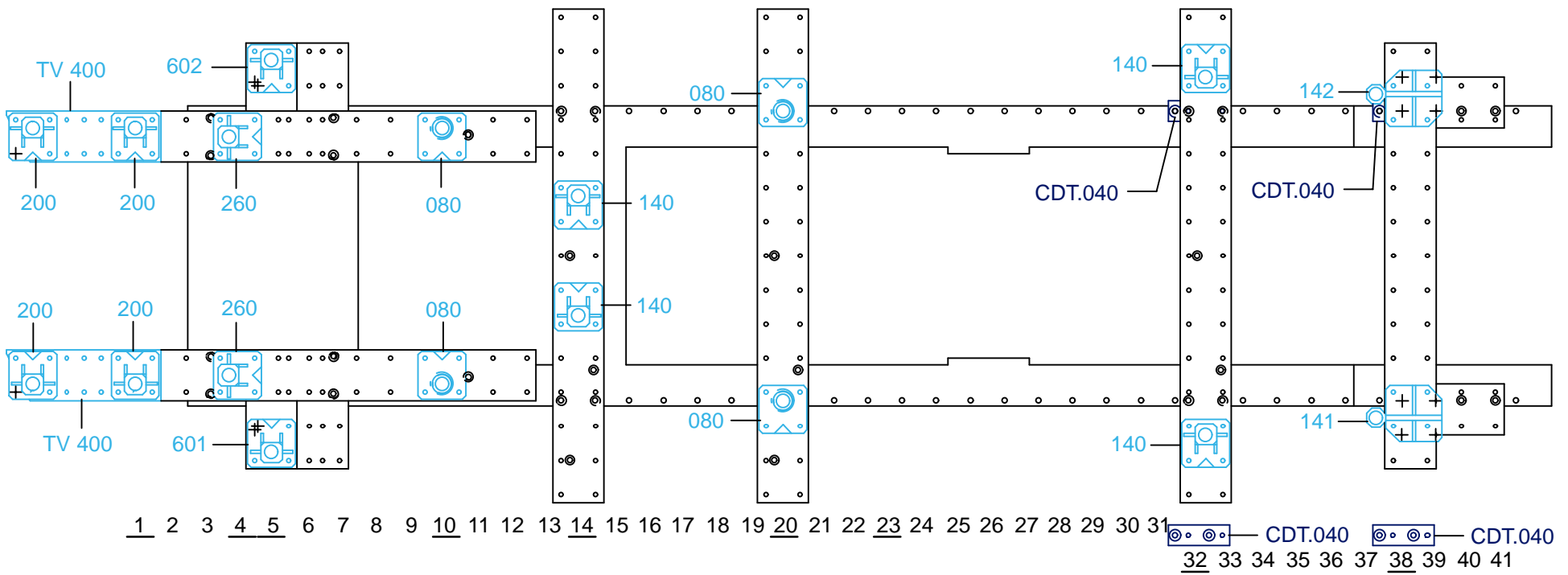

ANCRAGE DU VEHICULE
ANCHORING OF THE VEHICLE
VERANKERUNG DES FAHRZEUGS
ANCORAGGIO DEL VEICOLO
ANCLAJE DEL VEHICULO

AN.27.B + AN27.03
Ou/Or/Oder/O
AN.34



M8S
MT10
SVN
E66

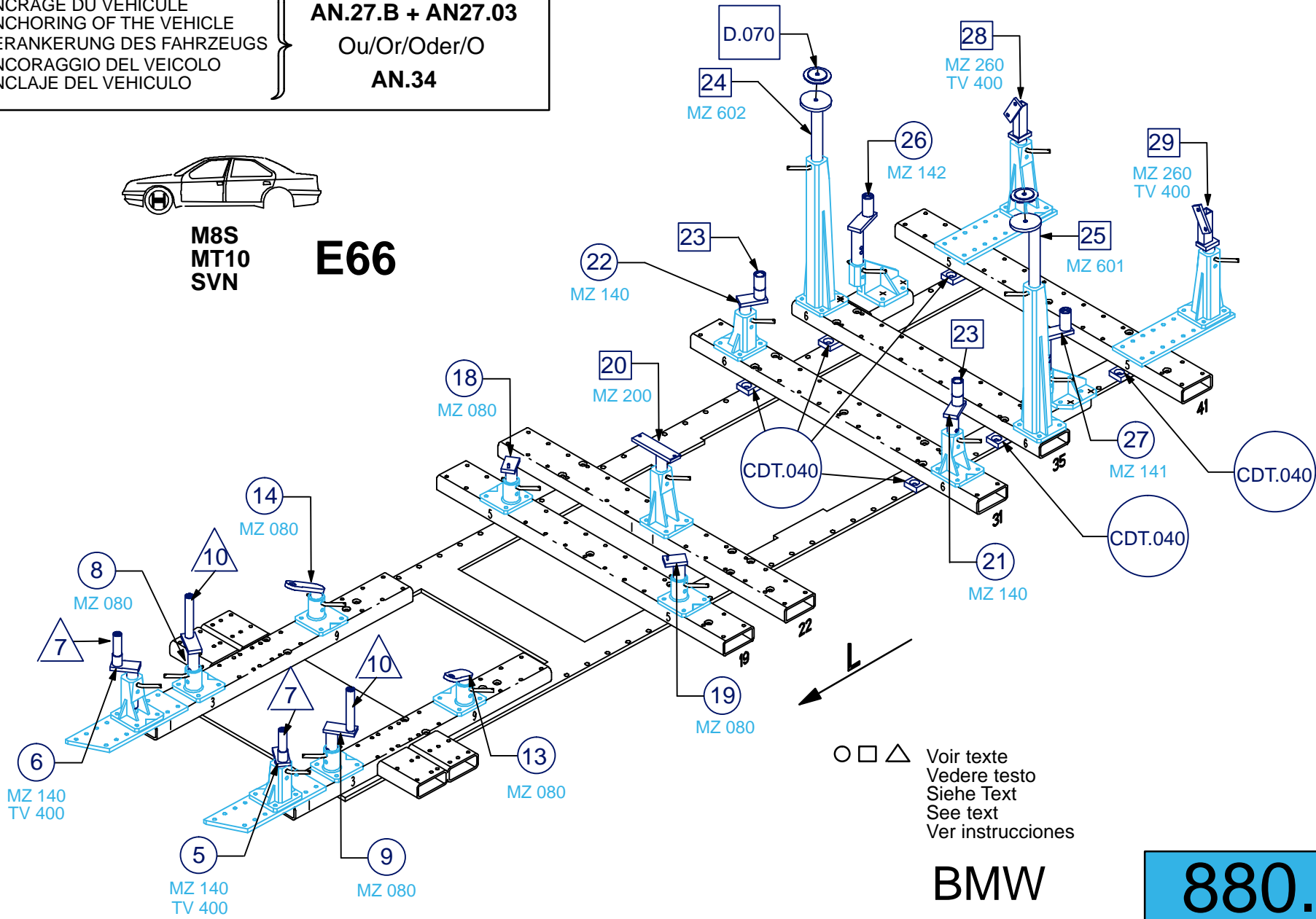

880.300
77 Kg | 24.09.2001 | 406-D-19D

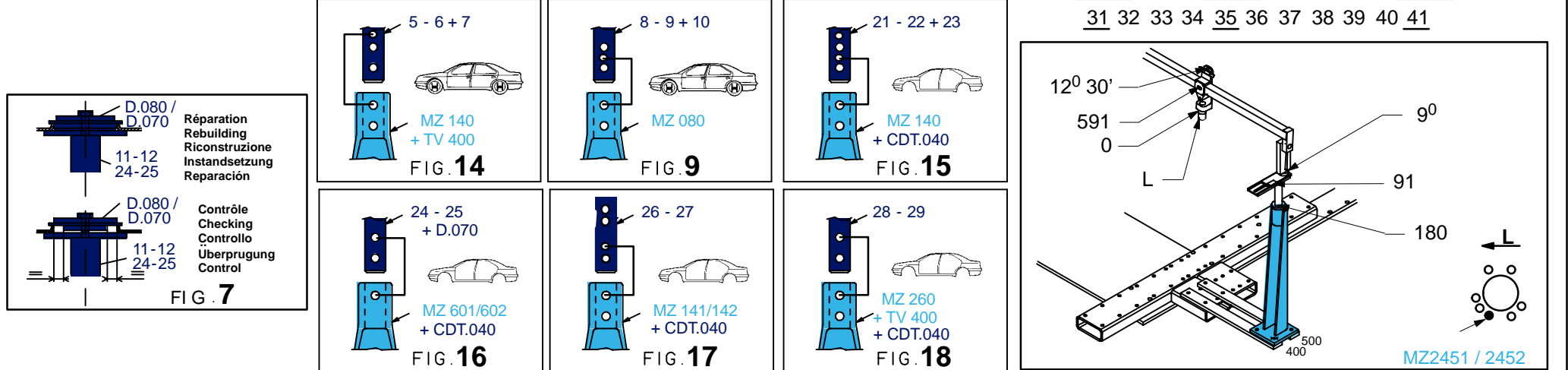
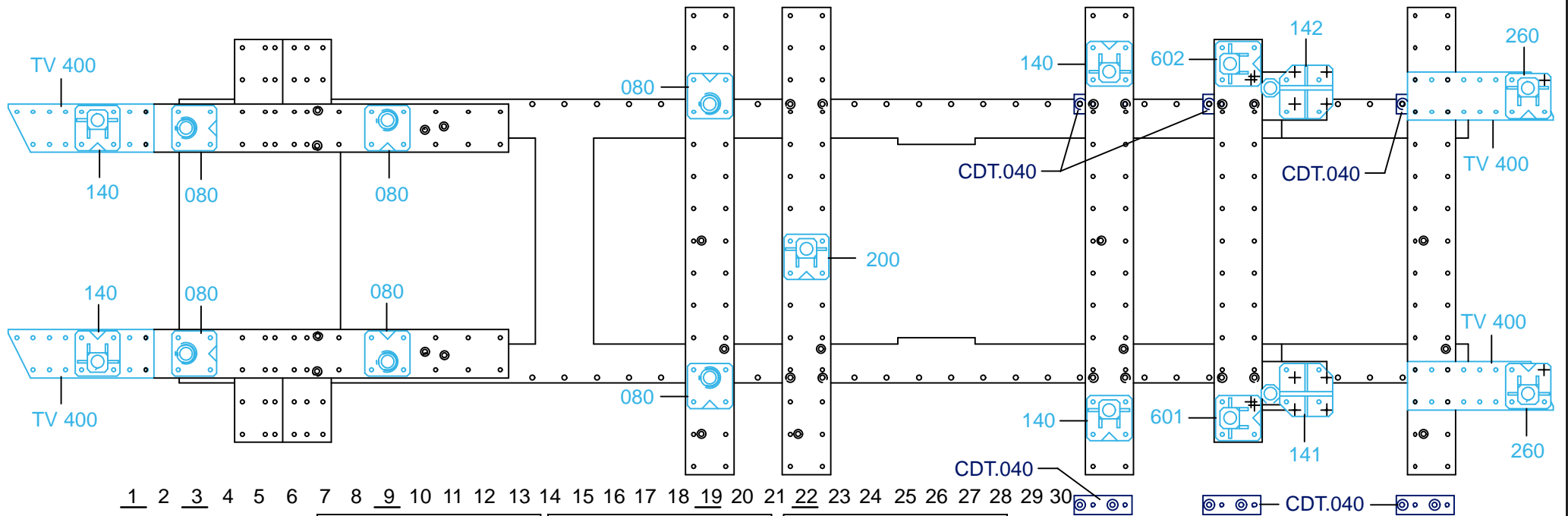

ANCRAGE DU VEHICULE
ANCHORING OF THE VEHICLE
VERANKERUNG DES FAHRZEUGS
ANCORAGGIO DEL VEICOLO
ANCLAJE DEL VEHICULO

AN.27.B + AN27.03
Ou/Or/Oder/O
AN.34

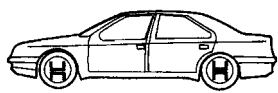

M8S
MT10
SVN
E66

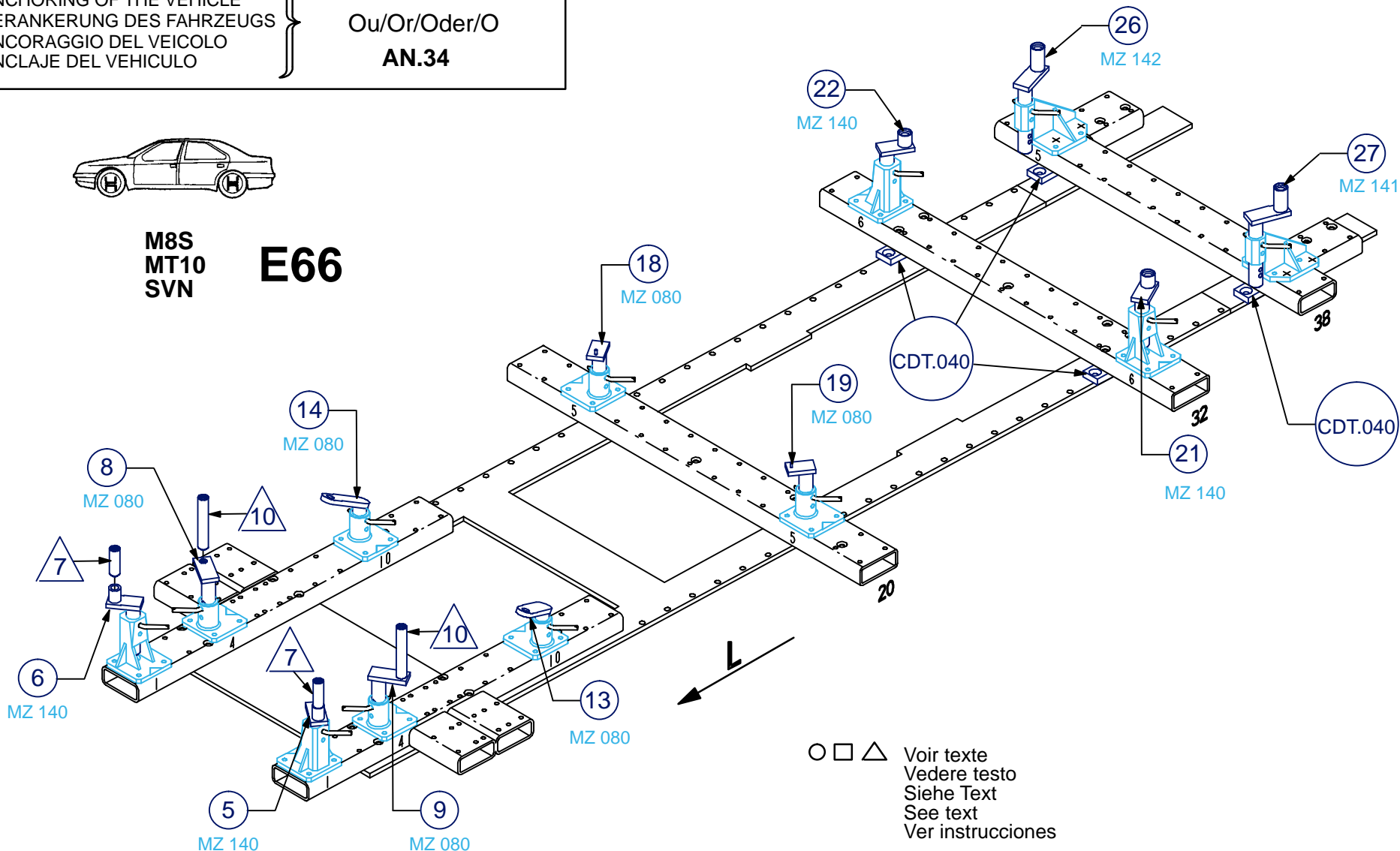

BMW

880.300

77 Kg | 24.09.2001 | 406-D-19E

