

○ Avec ou sans mécanique
 With or without mechanical elements
 Con o senza parti meccaniche
 Mit oder ohne Aggregate
 Con ó sin mecanica desmontada

REP.	REFERENCE	PDS	NB	MZ
1	876.7001	3,6	1	200
2	876.7002	3,6	1	200
3	876.7003	3,1	1	141
4	876.7004	3,1	1	142
5	876.7005	0,2	2	
6	876.7006	0,7	2	
7	876.7007	1,4	1	601
8	876.7008	1,4	1	602
9	876.7009	0,4	2	
10	876.7010	2,2	1	140/080
11	876.7011	2,2	1	140/080
12	876.7012	1,6	1	080
13	876.7013	1,6	1	080
14	876.7014	3,0	1	140
15	876.7015	3,0	1	140
16	876.7016	0,7	2	
17	876.7017	0,2	2	
18	876.7018	2,7	1	200/140
19	876.7019	2,7	1	200/140
20	876.7020	2,6	1	602
21	876.7021	2,6	1	601
22	876.7022	0,1	2	
23	876.7023	2,0	1	260
24	876.7024	2,0	1	260
	V32	0,1	2	

	M 8-25	6
	M 8-50	4
	M 12-20	4
	M 12-65	2
	M 12-80	2
	M 12-90	4
	M 14-70	2
	M 14-120	2
	M 8	6
	MU 12	4

FORD

876.300

50 Kg 29.03.2001 412-D-26A

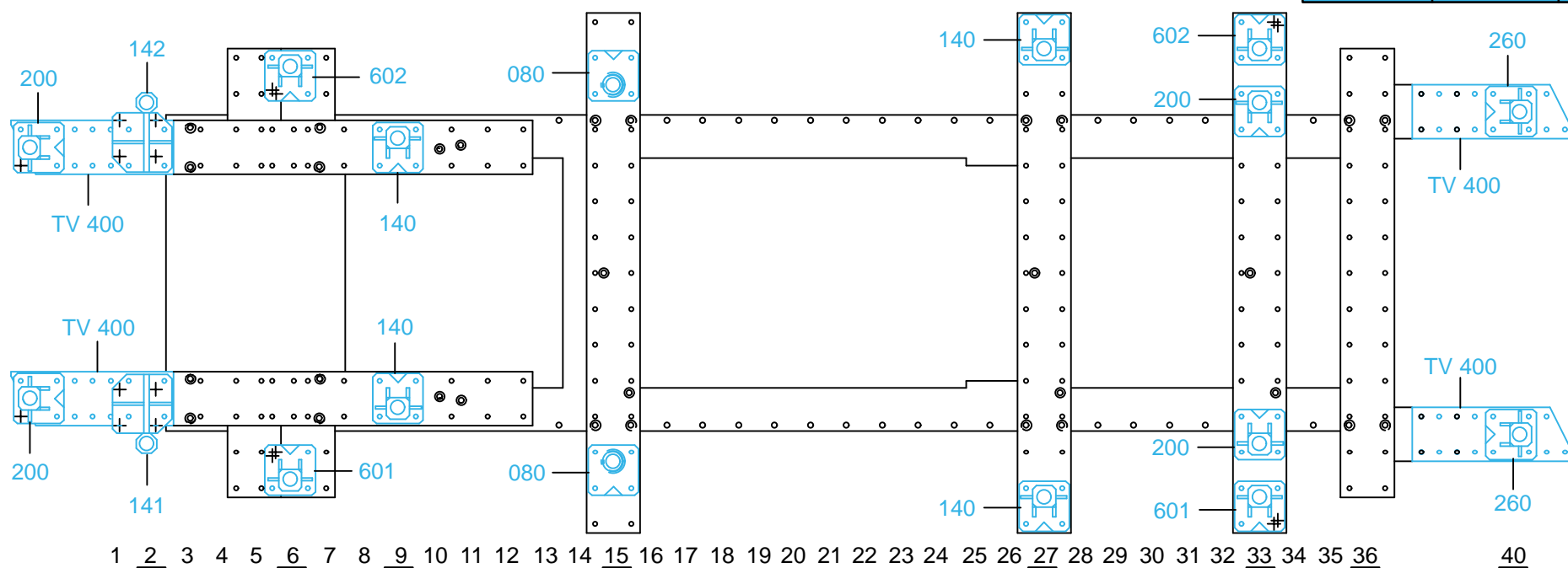

1 2 3 4 5 6 7 8 9 10 11 12 13 14 15 16 17 18 19 20 21 22 23 24 25 26 27 28 29 30 31 32 33 34 35 36 40

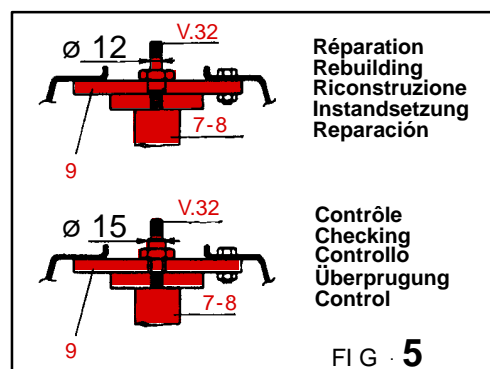
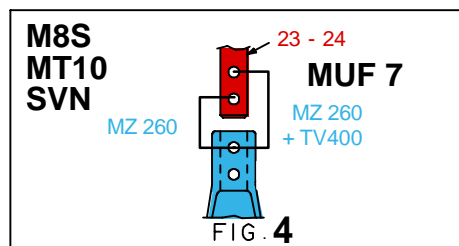
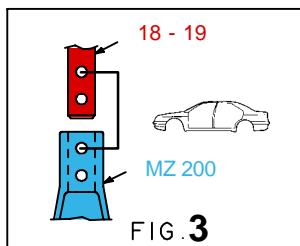
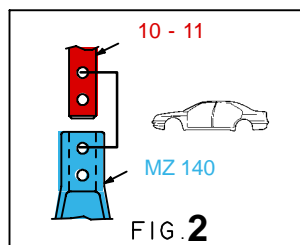
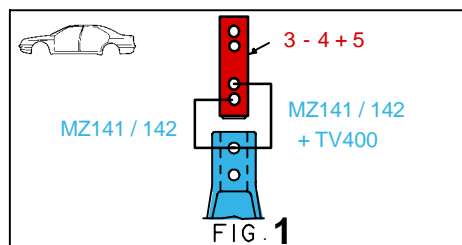

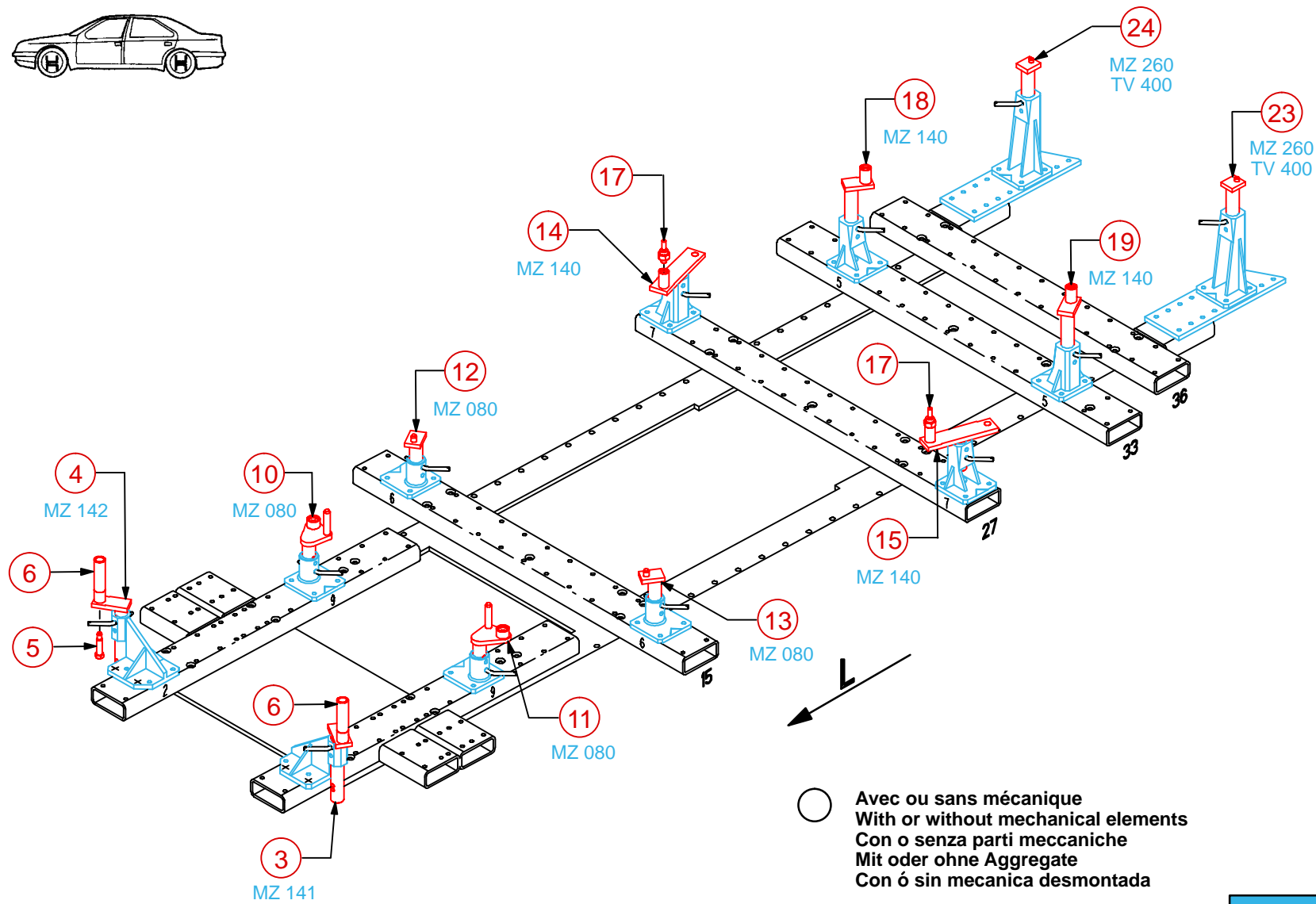
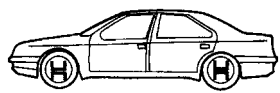

FORD

876.300

50 Kg 29.03.2001 412-D-26B

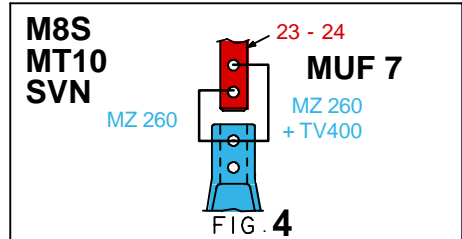
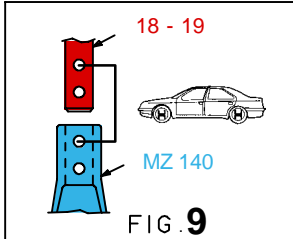
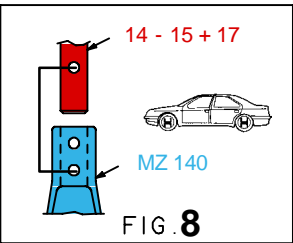
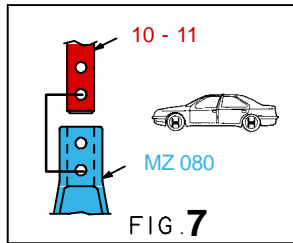
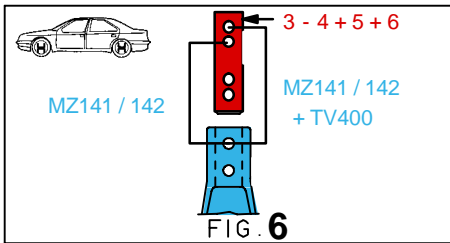
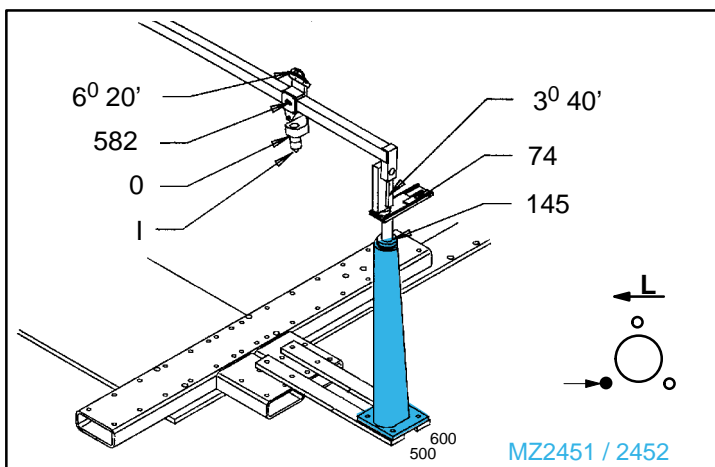
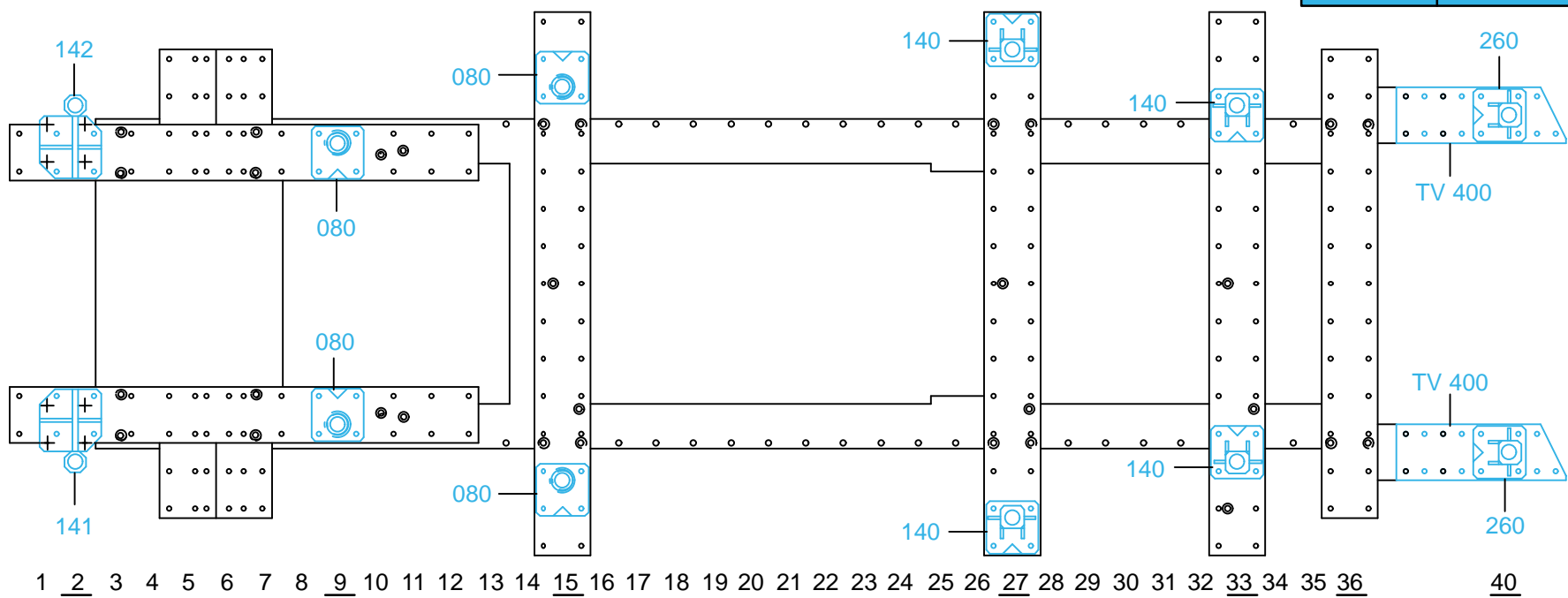

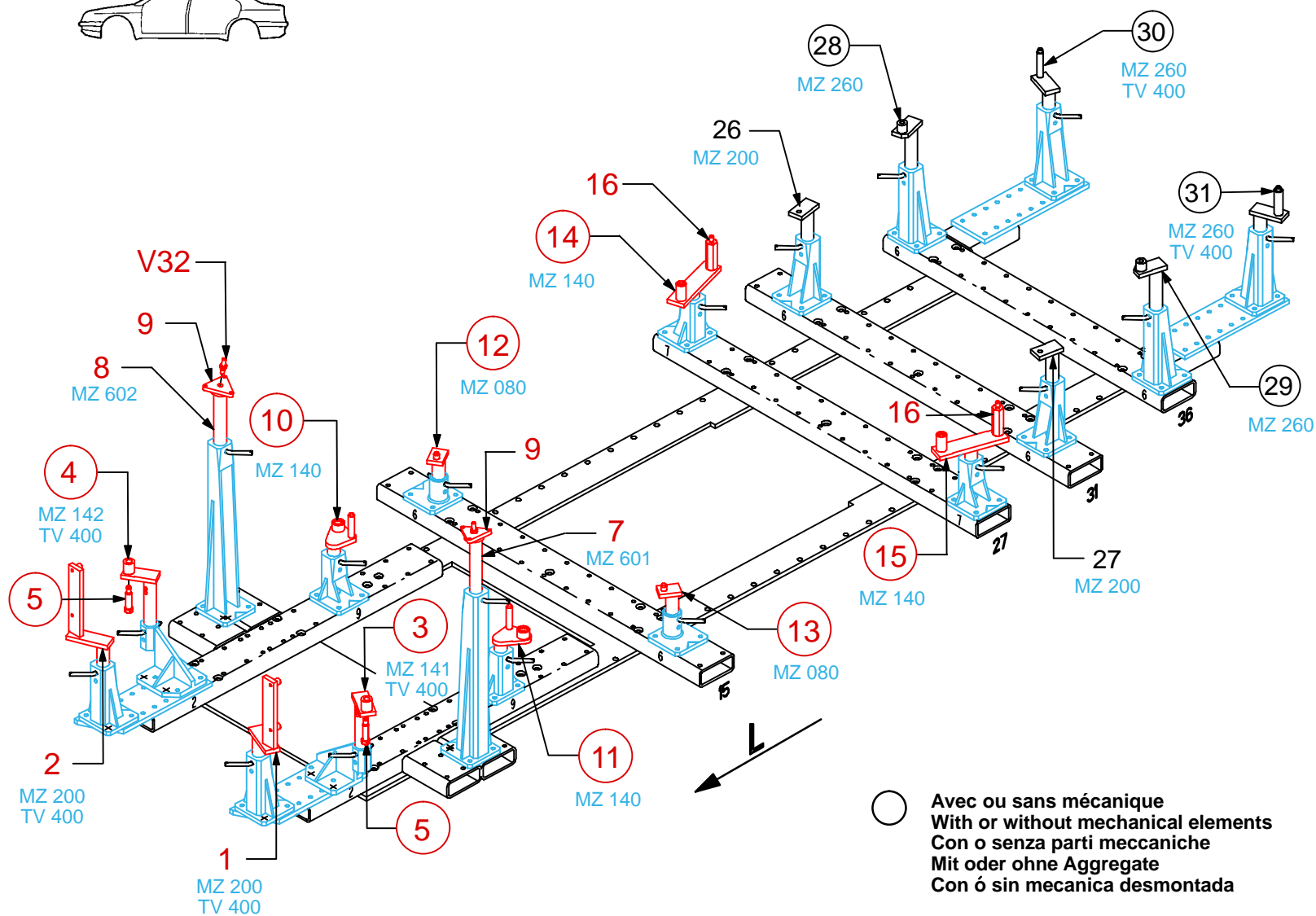

○ Avec ou sans mécanique
 With or without mechanical elements
 Con o senza parti meccaniche
 Mit oder ohne Aggregate
 Con ó sin mecanica desmontada

REP.	REFERENCE	PDS	NB	MZ
1	876.7001	3,6	1	200
2	876.7002	3,6	1	200
3	876.7003	3,1	1	141
4	876.7004	3,1	1	142
5	876.7005	0,2	2	
6	876.7006	0,7	2	
7	876.7007	1,4	1	601
8	876.7008	1,4	1	602
9	876.7009	0,4	2	
10	876.7010	2,2	1	140/080
11	876.7011	2,2	1	140/080
12	876.7012	1,6	1	080
13	876.7013	1,6	1	080
14	876.7014	3,0	1	140
15	876.7015	3,0	1	140
16	876.7016	0,7	2	
17	876.7017	0,2	2	
18	876.7018	2,7	1	200/140
19	876.7019	2,7	1	200/140
20	876.7020	2,6	1	602
21	876.7021	2,6	1	601
22	876.7022	0,1	2	
23	876.7023	2,0	1	260
24	876.7024	2,0	1	260
	V32	0,1	2	

M 8-25	6
M 8-50	4
M 12-20	4
M 12-65	2
M 12-80	2
M 12-90	4
M 14-70	2
M 14-120	2
M 8	6
MU 12	4

complément au
 complementary set to
 complemento al
 zusatz zu **671.309**

876.300

50 Kg 29.03.2001 412-D-26C

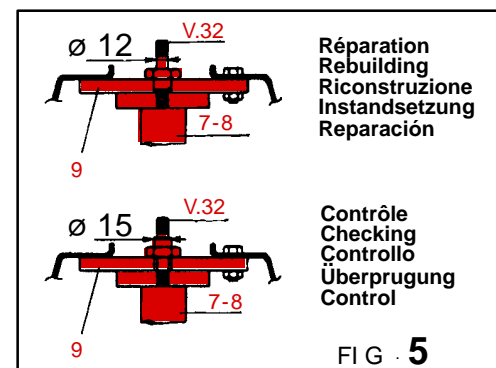
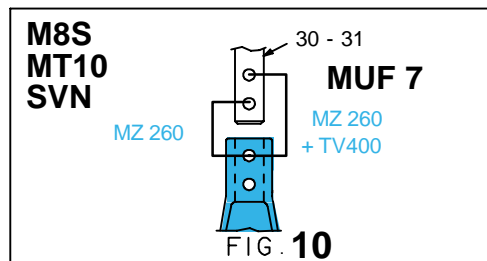
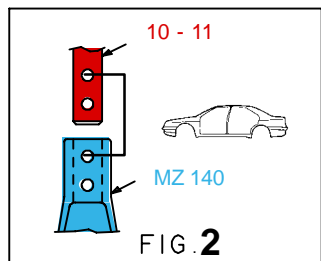
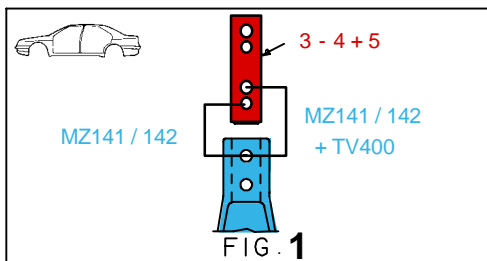
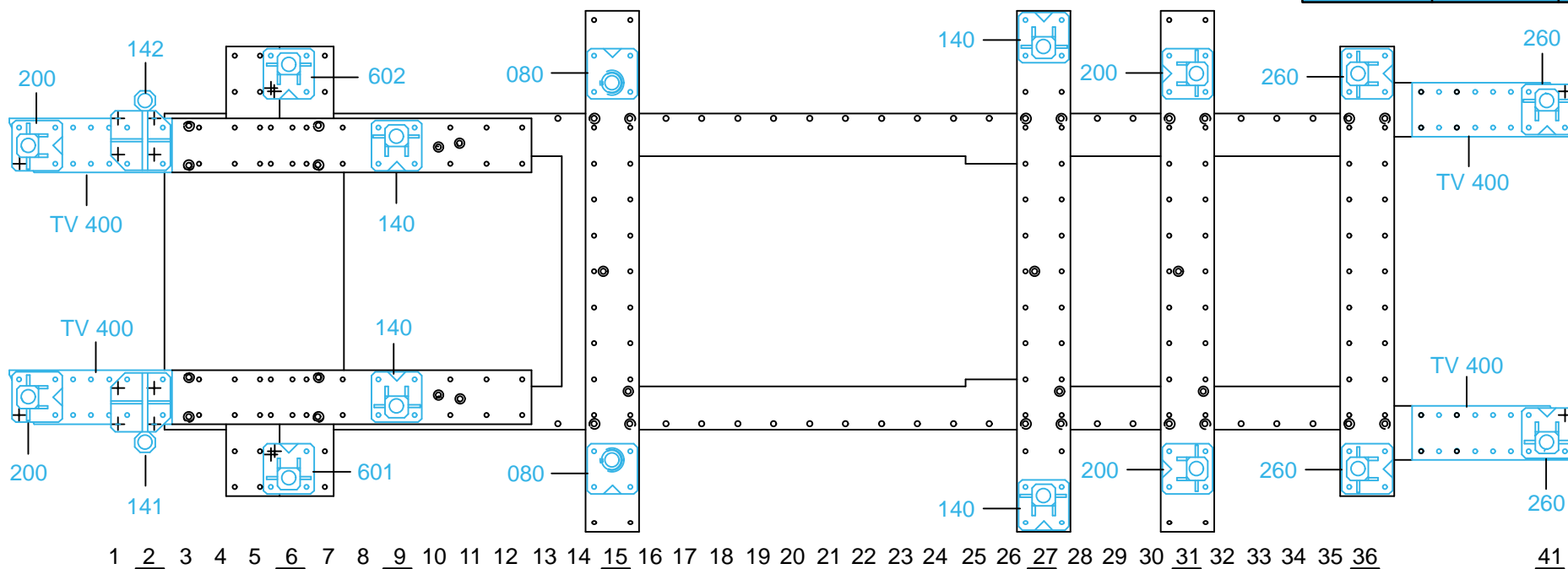

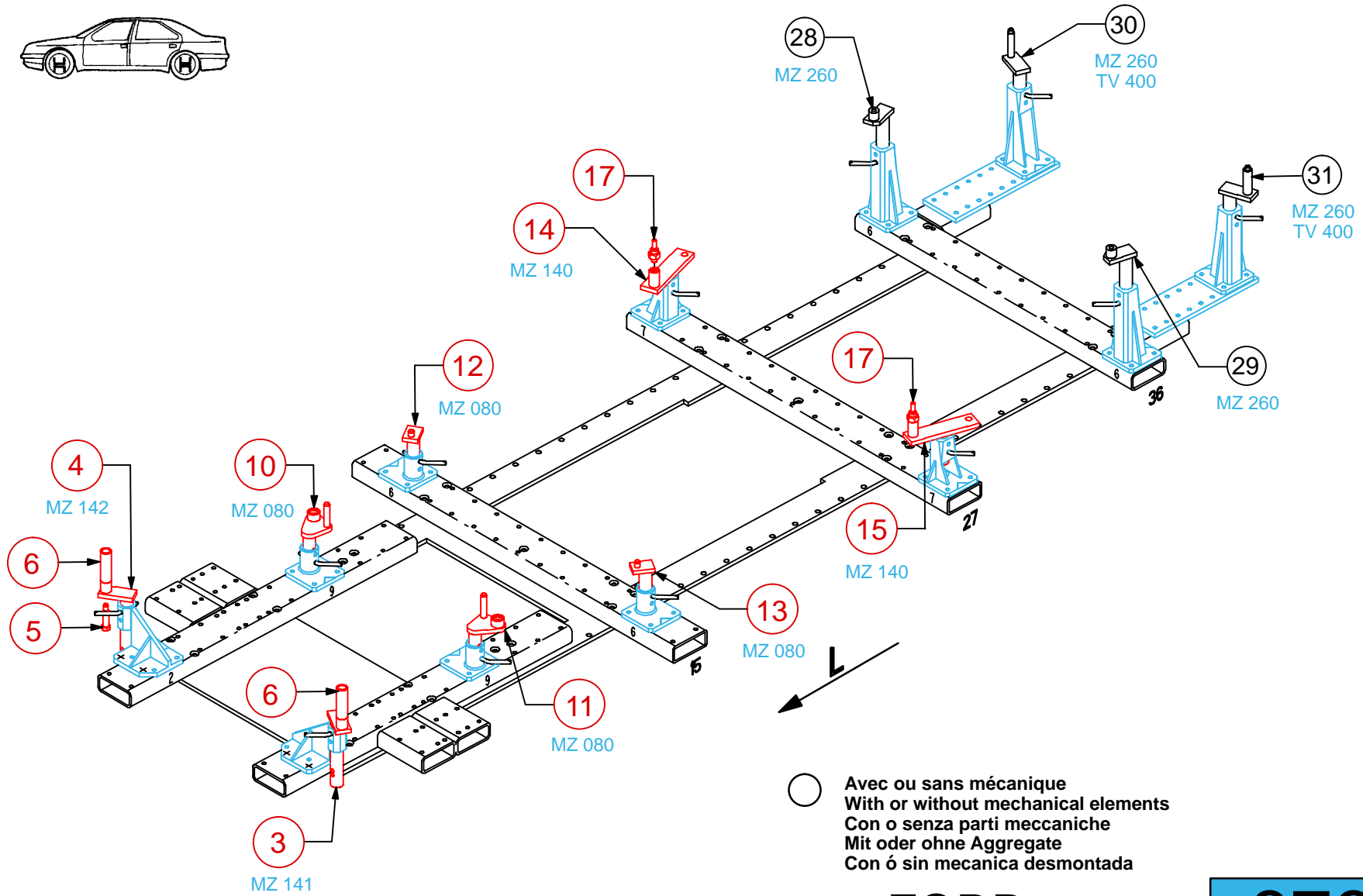
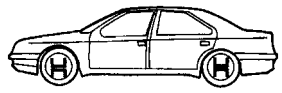

FORD

876.300

50 Kg 29.03.2001 412-D-26D

