

REP.	REFERENCE	PDS	NB	MZ
49	869.7049	2,9	1	200
50	869.7050	2,9	1	200

complément au
complementary set to
complemento al
zusatz zu

**869.310 +
869.309**

869.306

6 Kg 22.09.2008 434-D-73W

○ Avec ou sans mécanique
With or without mechanical elements
Con o senza parti meccaniche
Mit oder ohne Aggregate
Con ó sin mecanica desmontada

TOYOTA

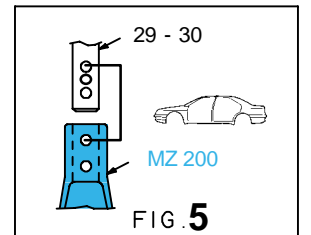
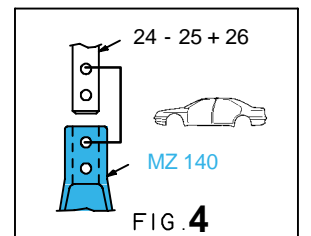
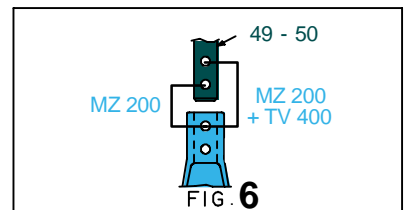
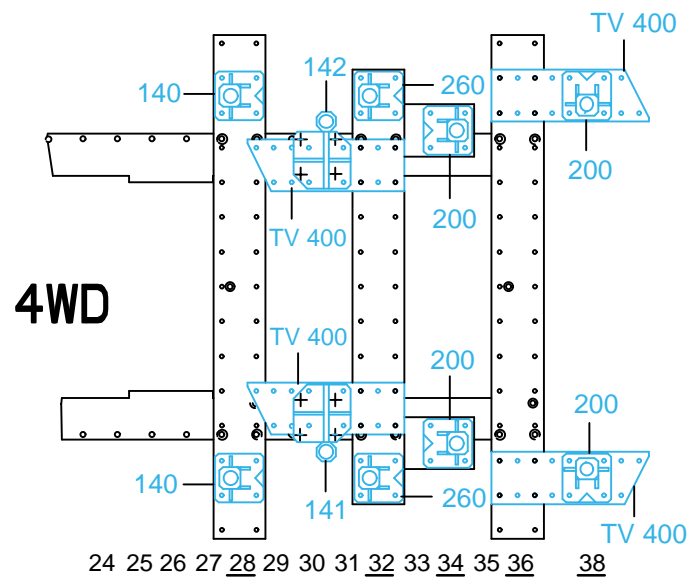
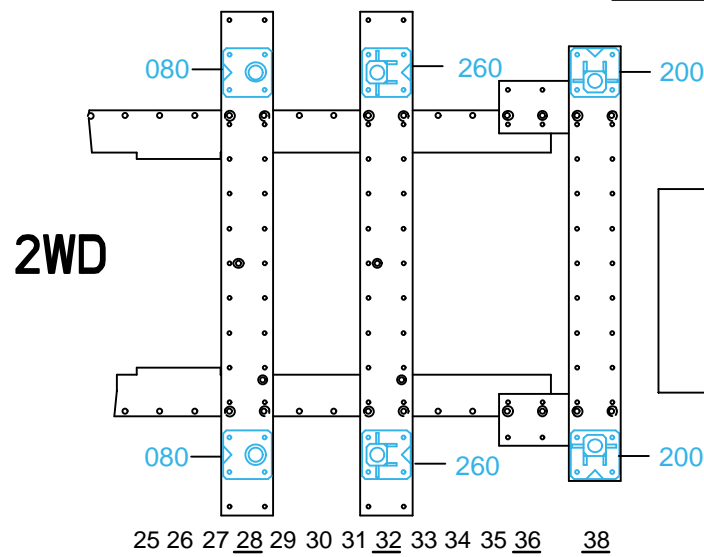
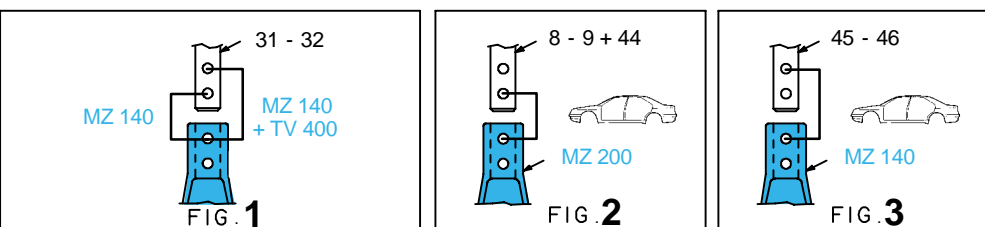
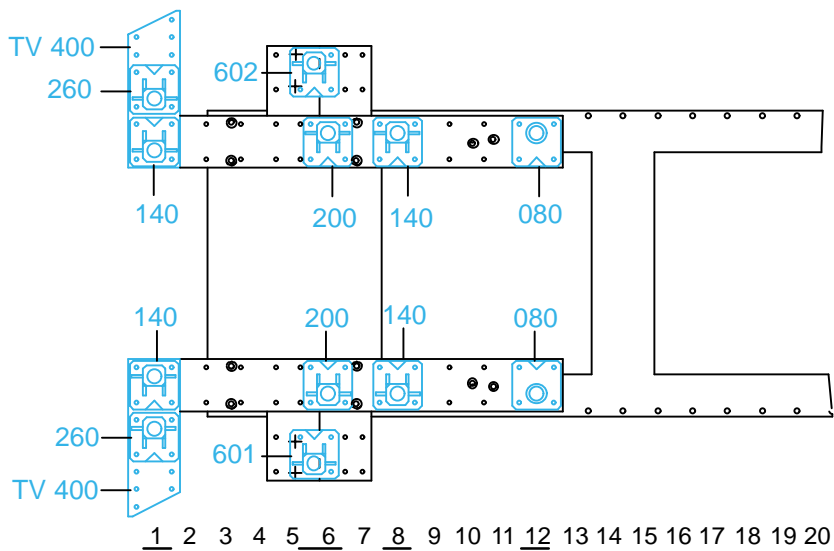
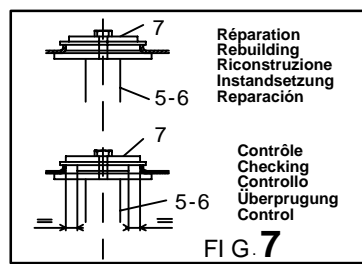

869.306-RVA3-1 01

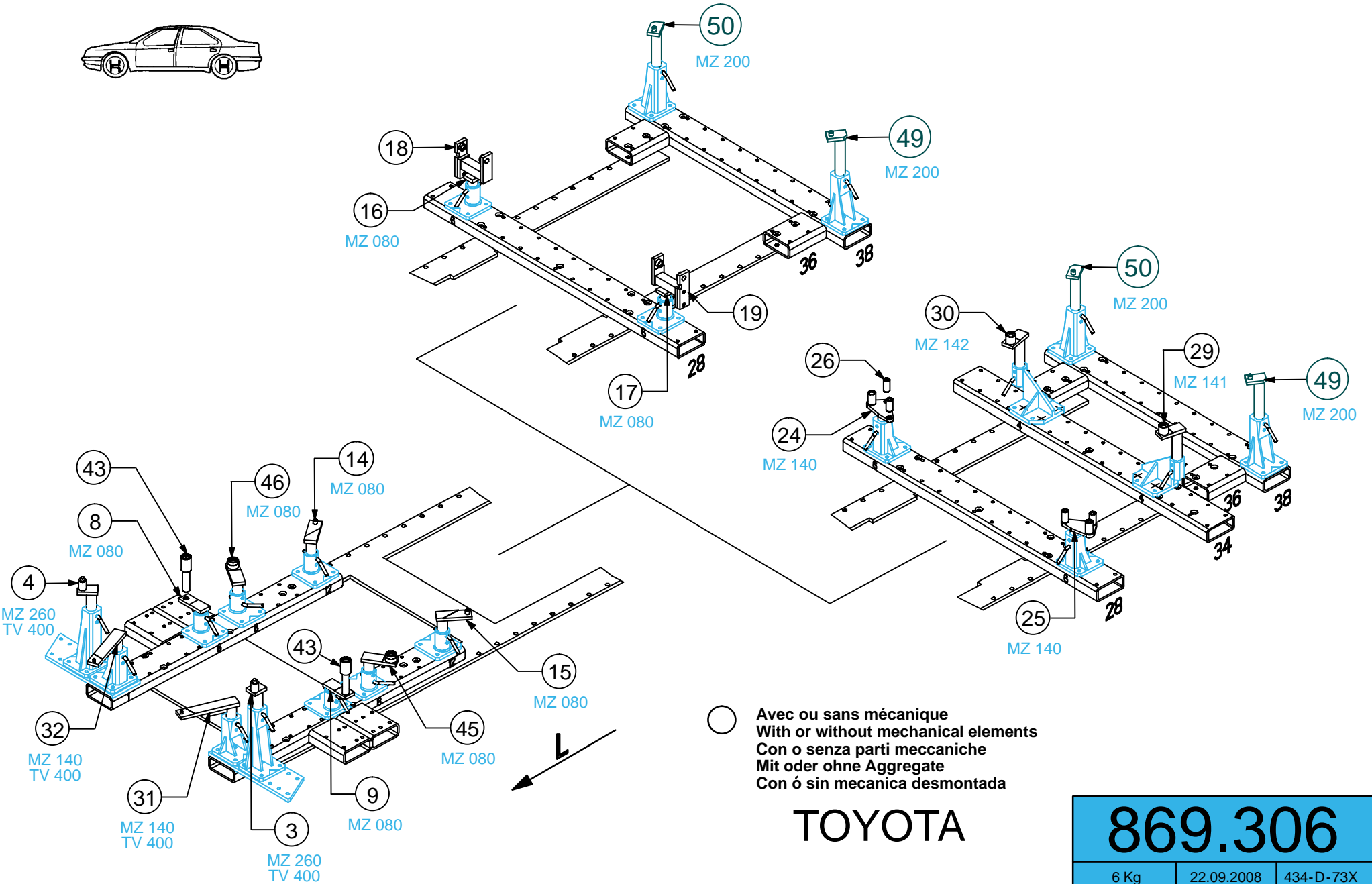

○ Avec ou sans mécanique
With or without mechanical elements
Con o senza parti meccaniche
Mit oder ohne Aggregate
Con ó sin mecánica desmontada

TOYOTA

869.306

6 Kg 22.09.2008 434-D-73X

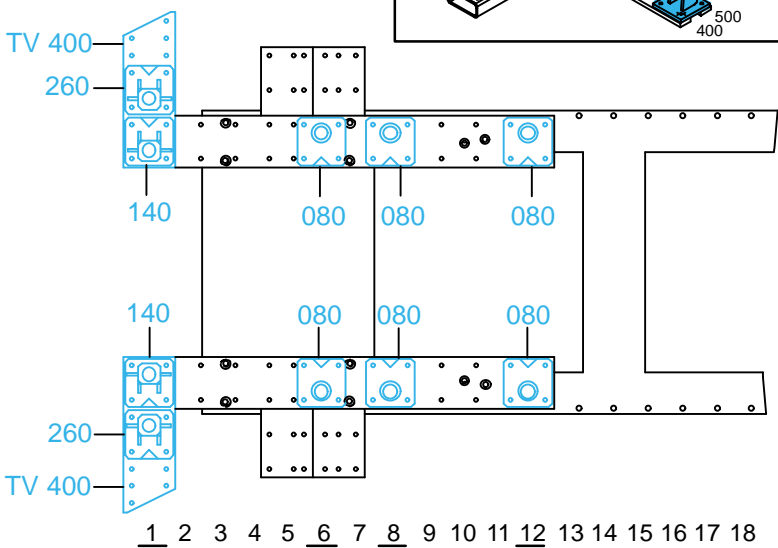
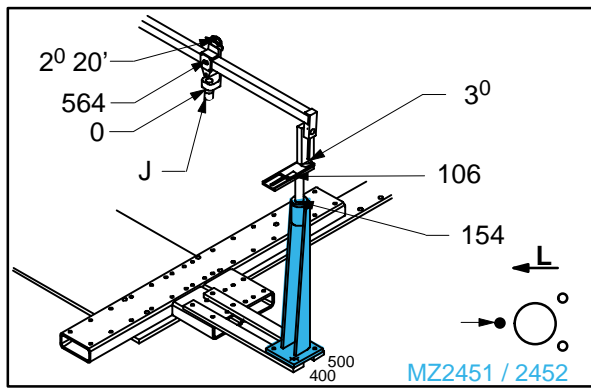

2WD

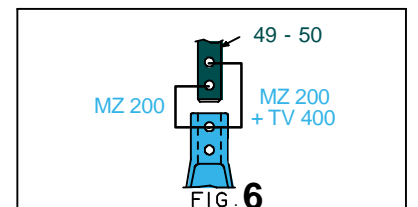
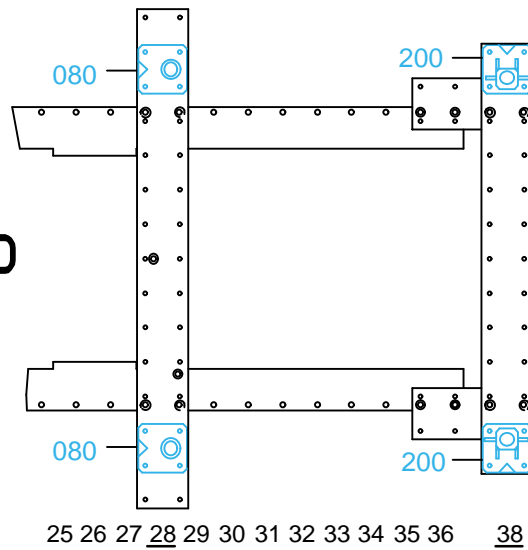

4WD

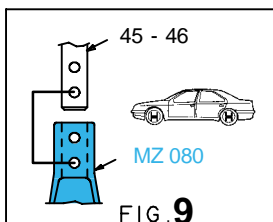
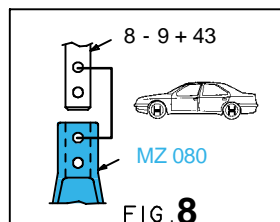
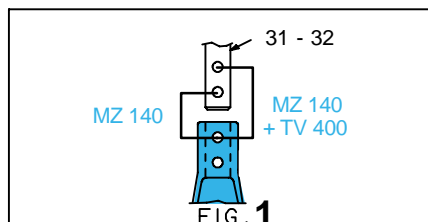
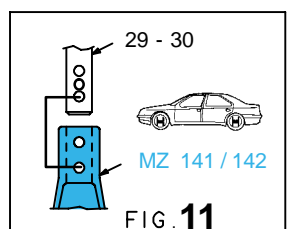
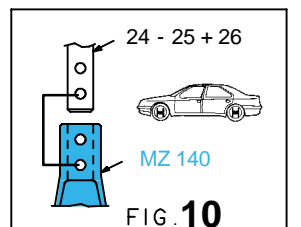
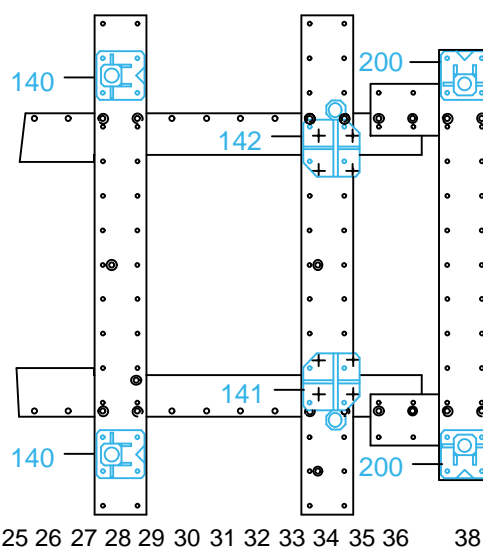

24 25 26 27 28 29 30 31 32 33 34 35 36 38

869.306-RVA3-1 | 01