

REP.	REFERENCE	PDS	NB	MZ
1	869.7001	2,5	1	140
2	869.7002	2,5	1	140
3	869.7003	2,1	1	260
4	869.7004	2,2	1	260
5	869.7005	2,2	1	601
6	869.7006	2,2	1	602
7	869.7007	0,8	2	
8	869.7008	1,6	1	260/080
9	869.7009	1,6	1	260/080
10	869.7010	1,1	2	
11	869.7011	0,8	2	
12	869.7012	1,9	1	080
13	869.7013	1,9	1	080
14	869.7014	2,0	1	080
15	869.7015	2,0	1	080
16	869.7016	2,8	1	080
17	869.7017	2,8	1	080
18	869.7018	0,9	1	
19	869.7019	0,9	1	
20	869.7020	2,7	1	260
21	869.7021	2,7	1	260
22	869.7022	1,4	1	200
23	869.7023	1,4	1	200
24	869.7024	1,9	1	140
25	869.7025	1,9	1	140
26	869.7026	0,2	4	
27	869.7027	2,4	1	141
28	869.7028	2,4	1	142
29	869.7029	3,0	1	200/141
30	869.7030	3,0	1	200/142
	E47	0,1	2	

M 10-30	6
M 12-20	2
M 12-30	6
M 10x1,25-30	2
M 12x1,25-30	2
M 12x1,25-90	6
M 14x1,50-50	2
M 14x1,50-70	2
M 14x1,50-90	2
M 10	6

○ Avec ou sans mécanique
With or without mechanical elements
Con o senza parti meccaniche
Mit oder ohne Aggregate
Con ó sin mecanica desmontada

TOYOTA

869.300

62 Kg 12.09.2001 434-D-73A

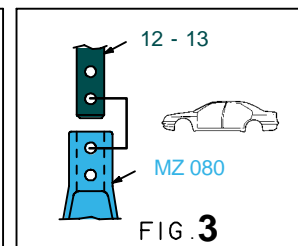
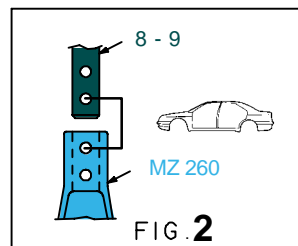
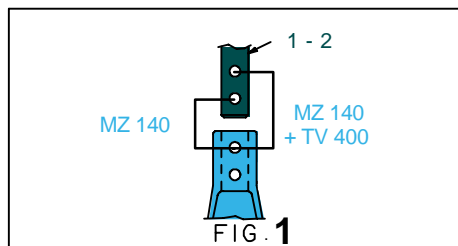
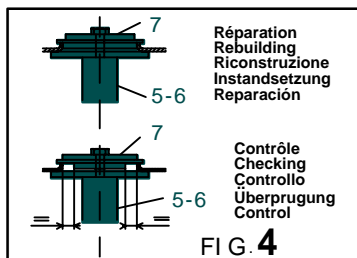
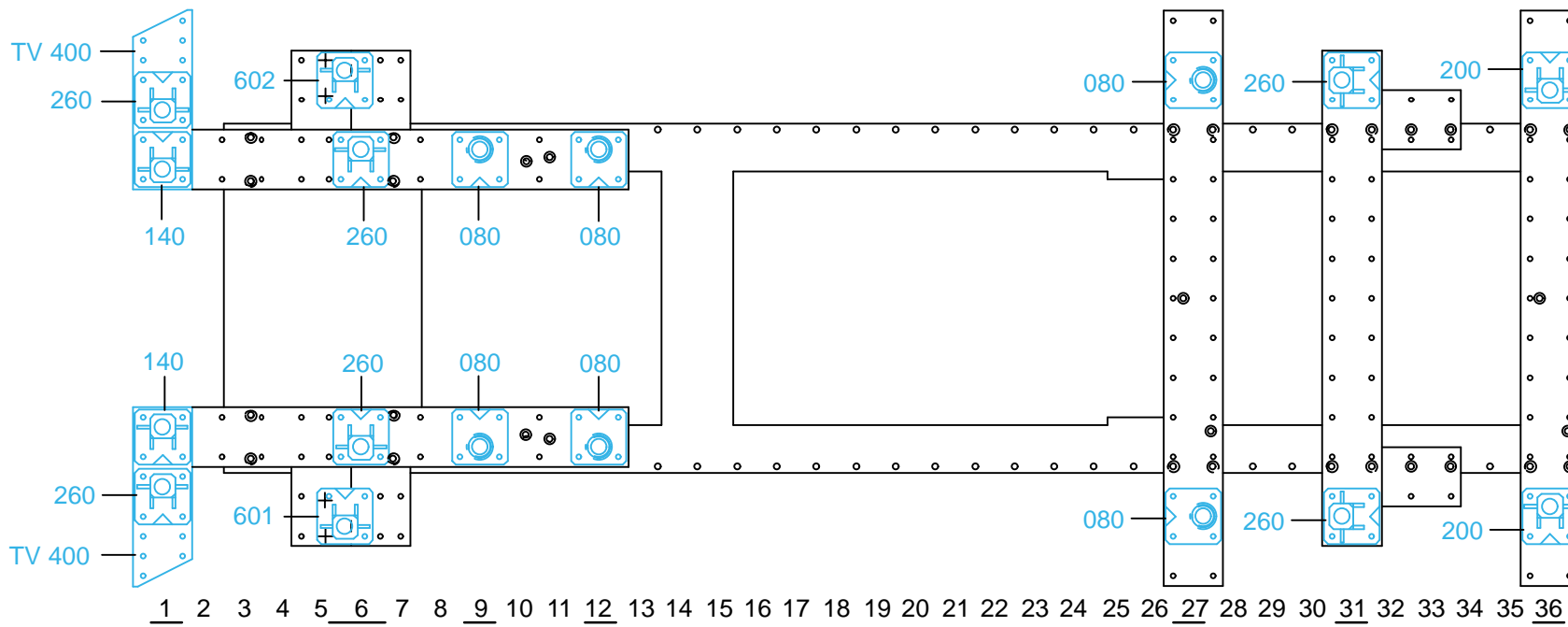

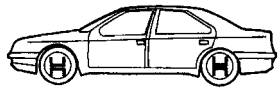

2WD

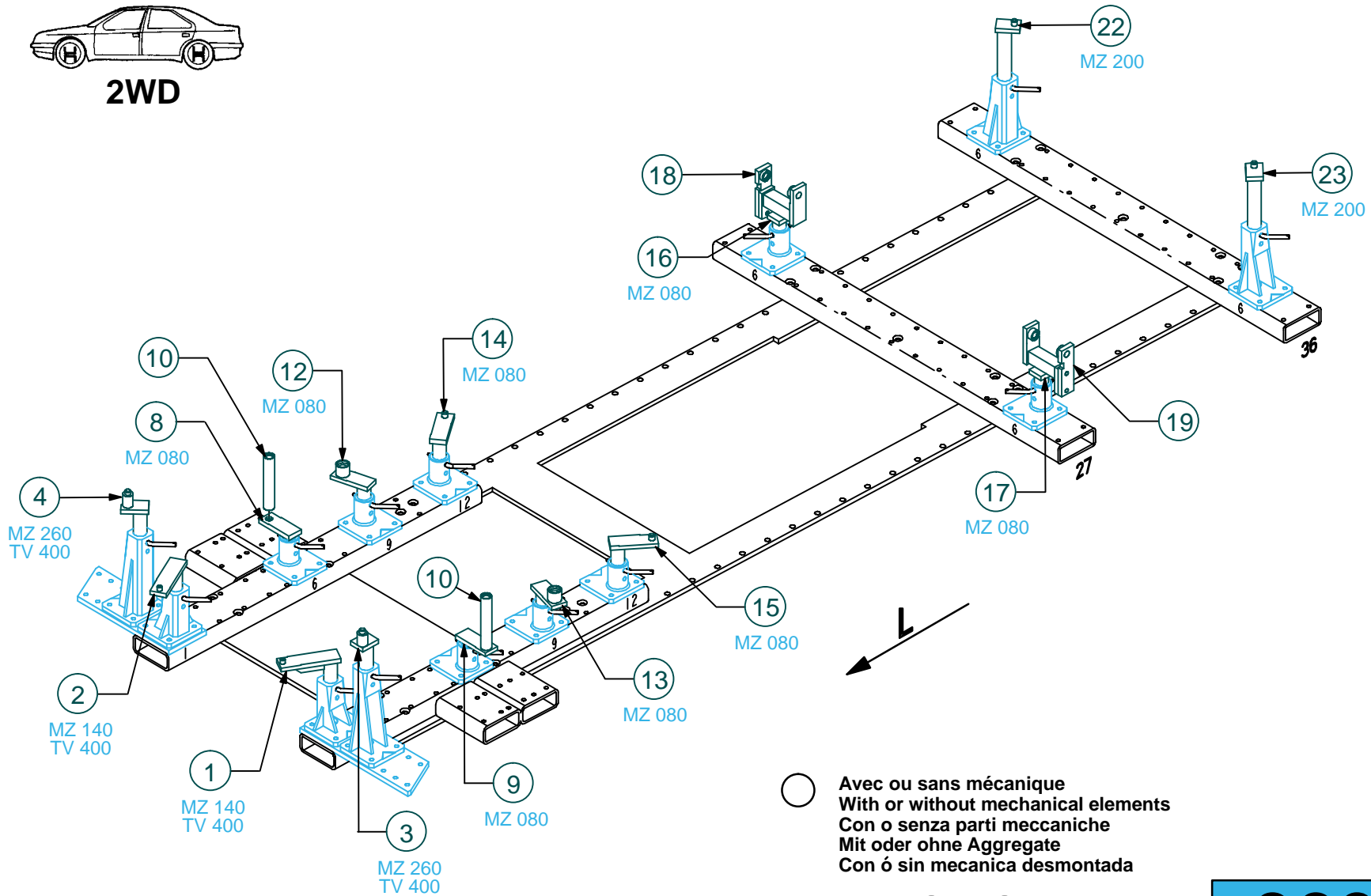

○ Avec ou sans mécanique
With or without mechanical elements
Con o senza parti meccaniche
Mit oder ohne Aggregate
Con ó sin mecanica desmontada

TOYOTA

869.300

62 Kg 30.05.2001 434-D-73B

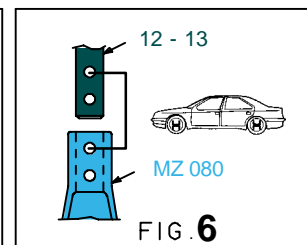
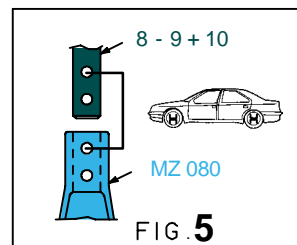
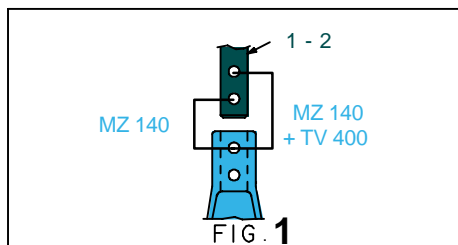
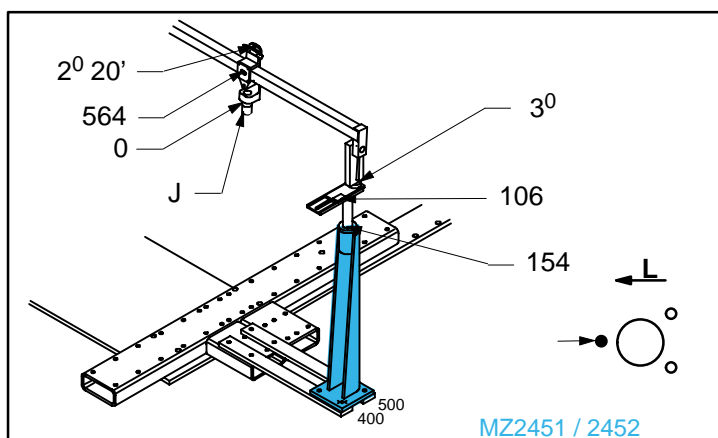
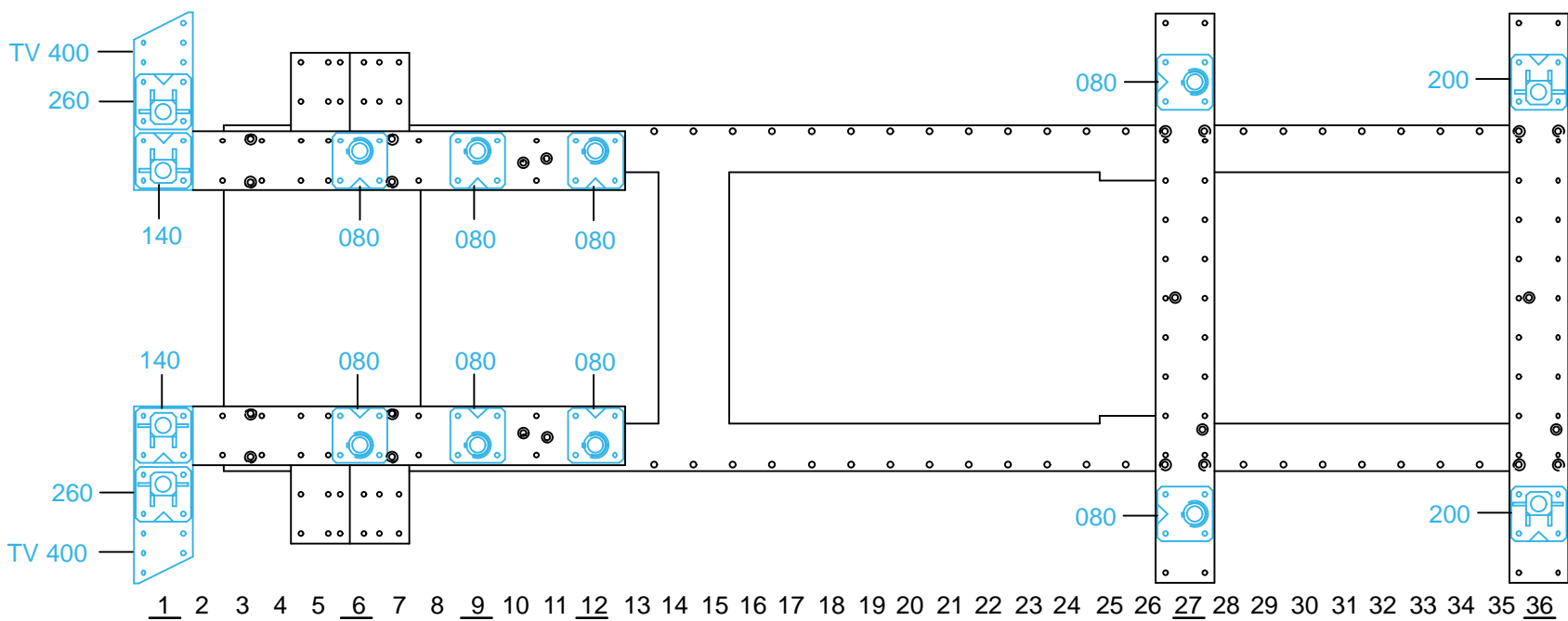

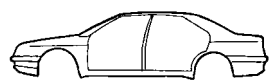

4WD

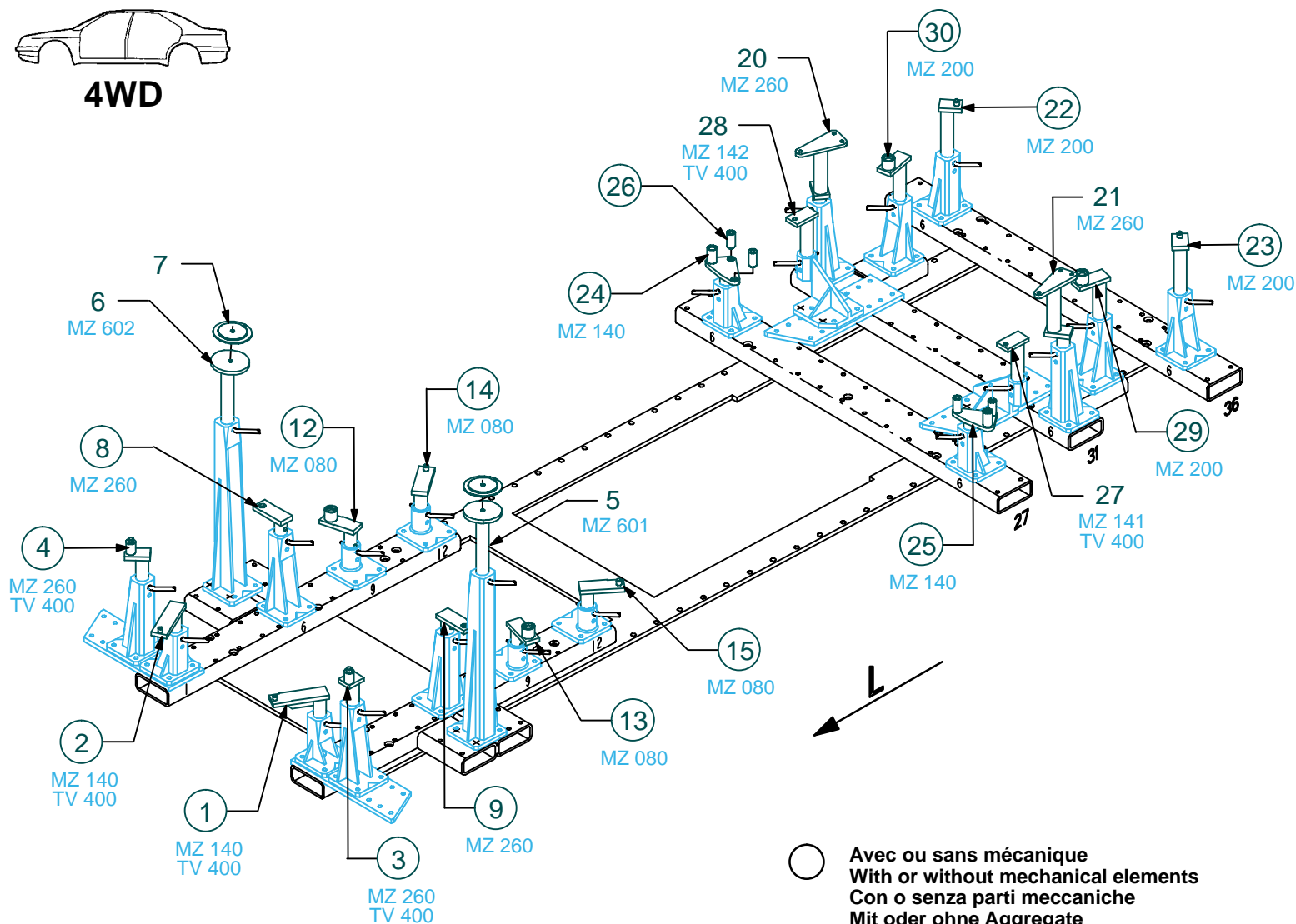

○ Avec ou sans mécanique
With or without mechanical elements
Con o senza parti meccaniche
Mit oder ohne Aggregate
Con ó sin mecanica desmontada

TOYOTA

869.300

62 Kg 30.05.2001 434-D-73C

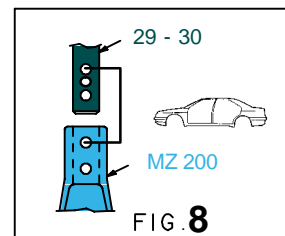
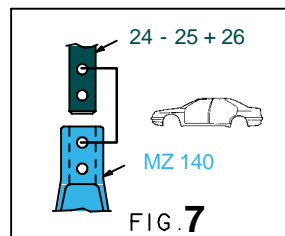
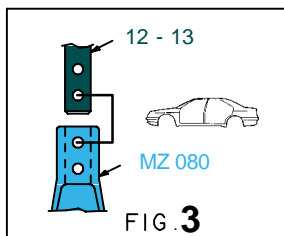
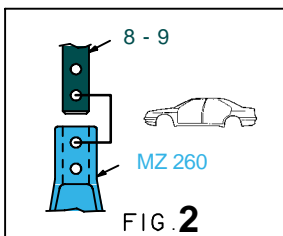
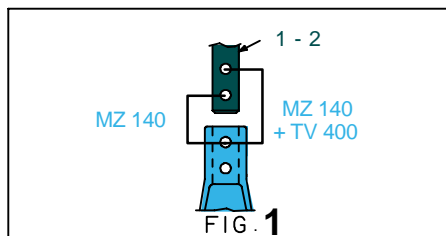
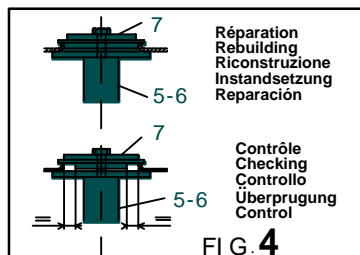
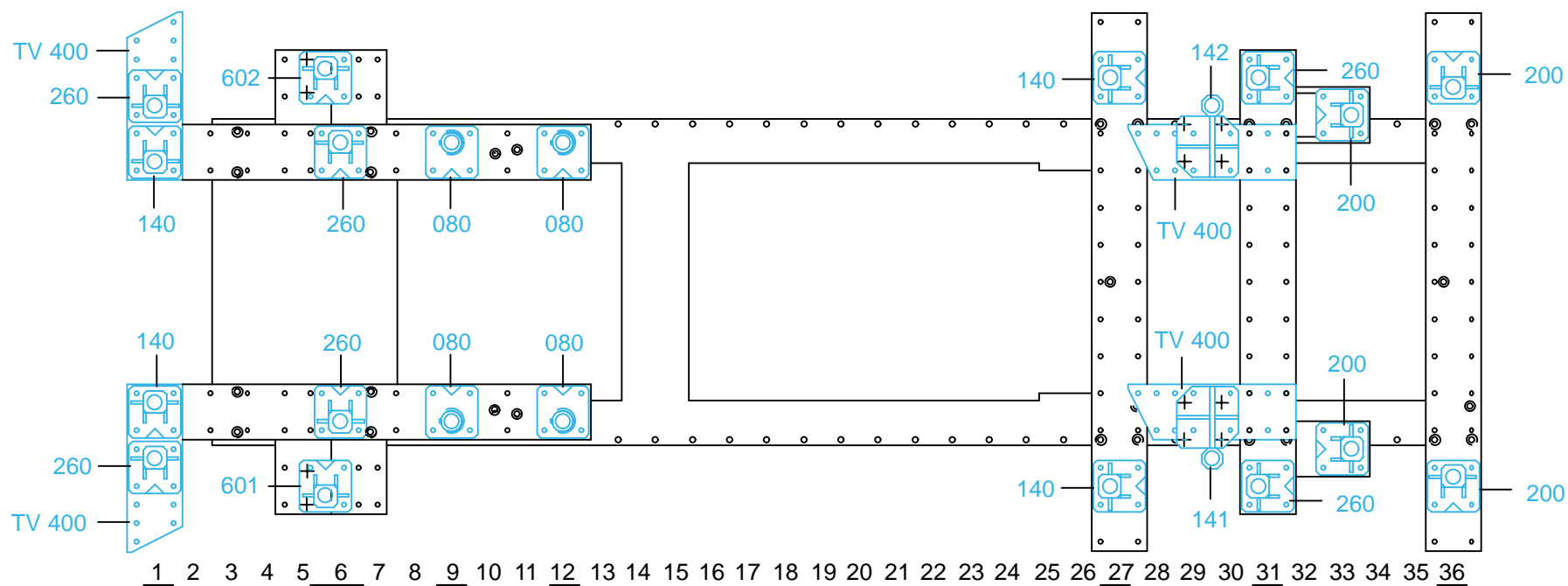

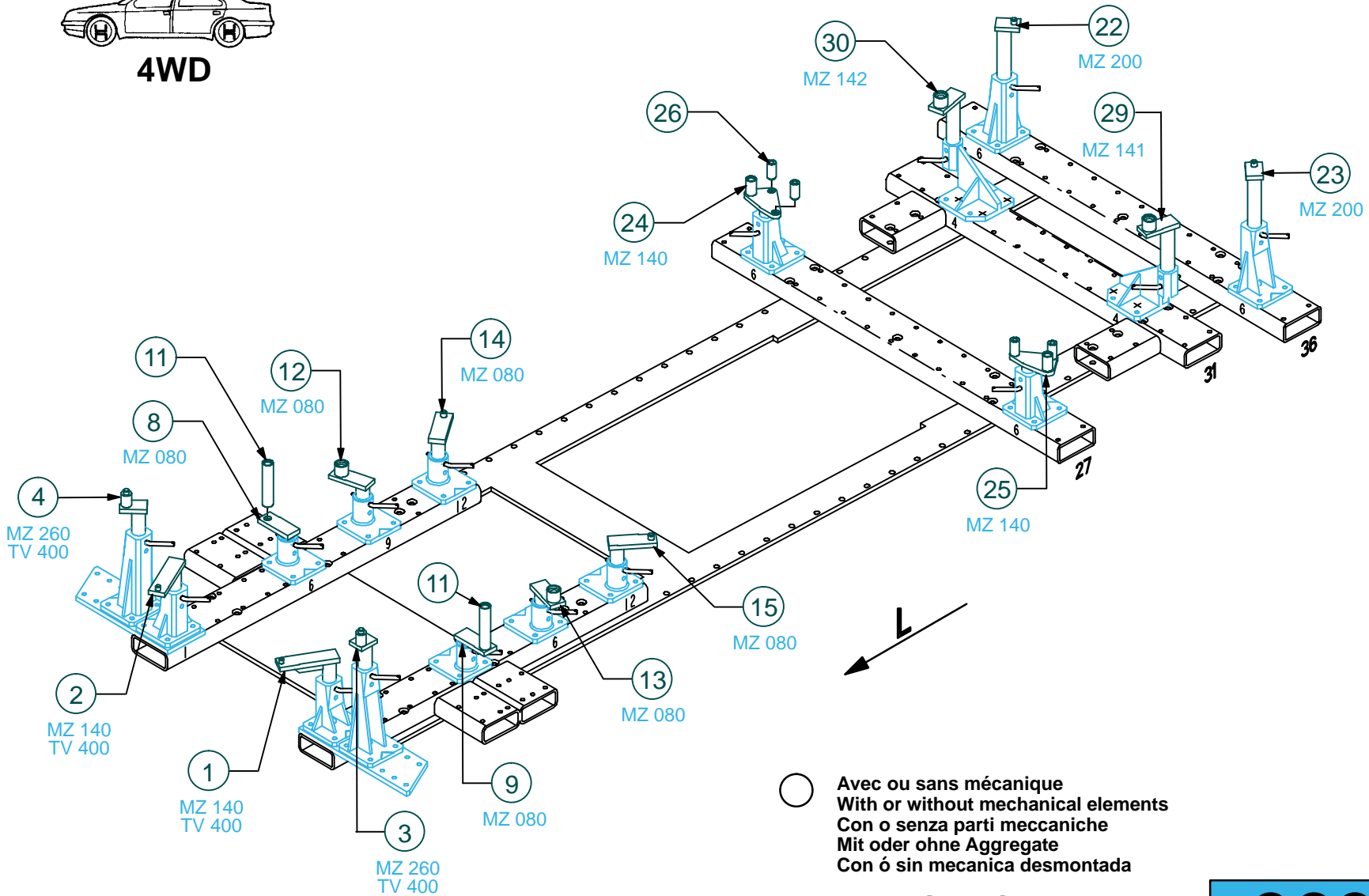

TOYOTA

869.300

62 Kg 30.05.2001 434-D-73D

