

REP.	REFERENCE	PDS	NB	MZ
1	864.7001	3,9	1	260
2	864.7002	3,9	1	260
3	864.7003	3,1	1	
4	864.7004	3,1	1	
5	864.7005	2,6	1	260
6	864.7006	3,5	1	602
7	864.7007	2,3	1	260
8	864.7008	2,3	1	260
9	864.7009	2,8	1	601
10	864.7010	2,8	1	602
11	864.7011	1,5	2	
12	864.7012	1,8	1	140/080
13	864.7013	1,8	1	140/080
14	864.7014	1,8	1	080
15	864.7015	1,8	1	080
16	864.7016	1,4	1	080
17	864.7017	1,4	1	080
18	864.7018	2,2	1	080
19	864.7019	2,2	1	080
20	864.7020	2,7	1	260
21	864.7021	2,7	1	260
22	864.7022	2,4	1	200
23	864.7023	2,4	1	200
24	864.7024	1,5	1	
25	864.7025	1,5	1	
26	864.7026	1,5	1	
27	864.7027	0,8	1	
28	864.7028	3,4	1	
29	864.7029	3,4	1	
30	864.7030	3,0	1	602
31	864.7031	3,0	1	601
32	864.7032	1,3	2	
33	864.7033	2,8	1	260
34	864.7034	2,8	1	260
35	864.7035	1,4	1	
36	864.7036	1,4	1	
37	864.7037	0,2	2	

M 8-25	10
M 10-25	2
M 10-60	2
M 12-20	1
M 12-25	8
M 12-30	2
M 12-65	2
M 12-80	6
M 12-150	2
M 14-80	2
M 10	2
M 14	2

RENAULT

864.310

88 Kg | 27.12.2001 | 427-D-25G

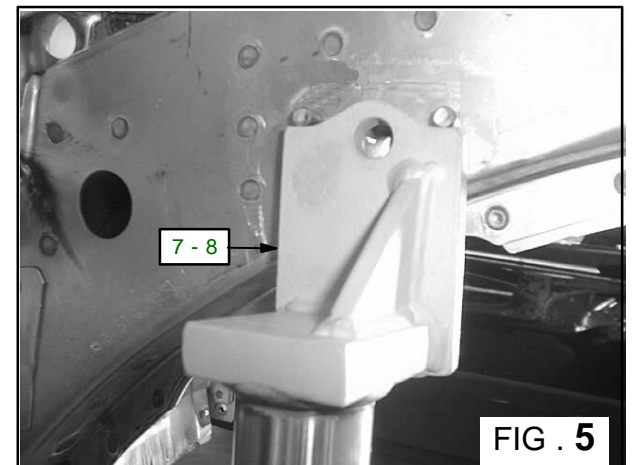
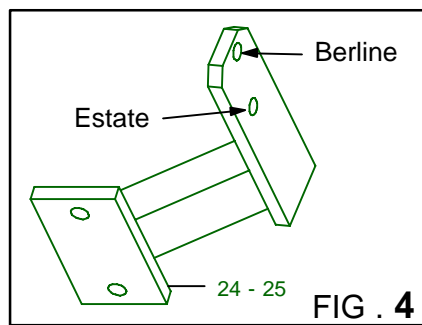
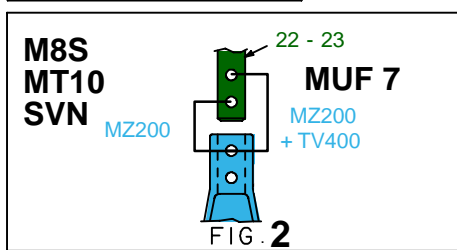
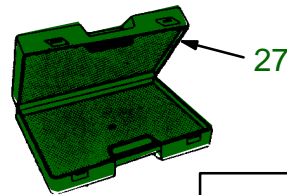
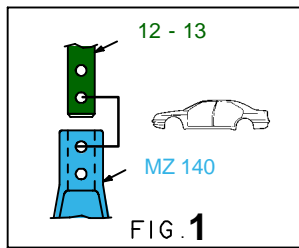
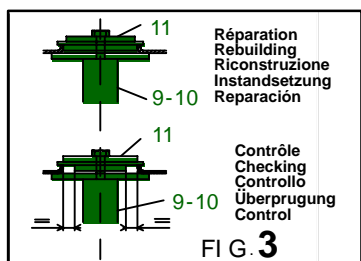
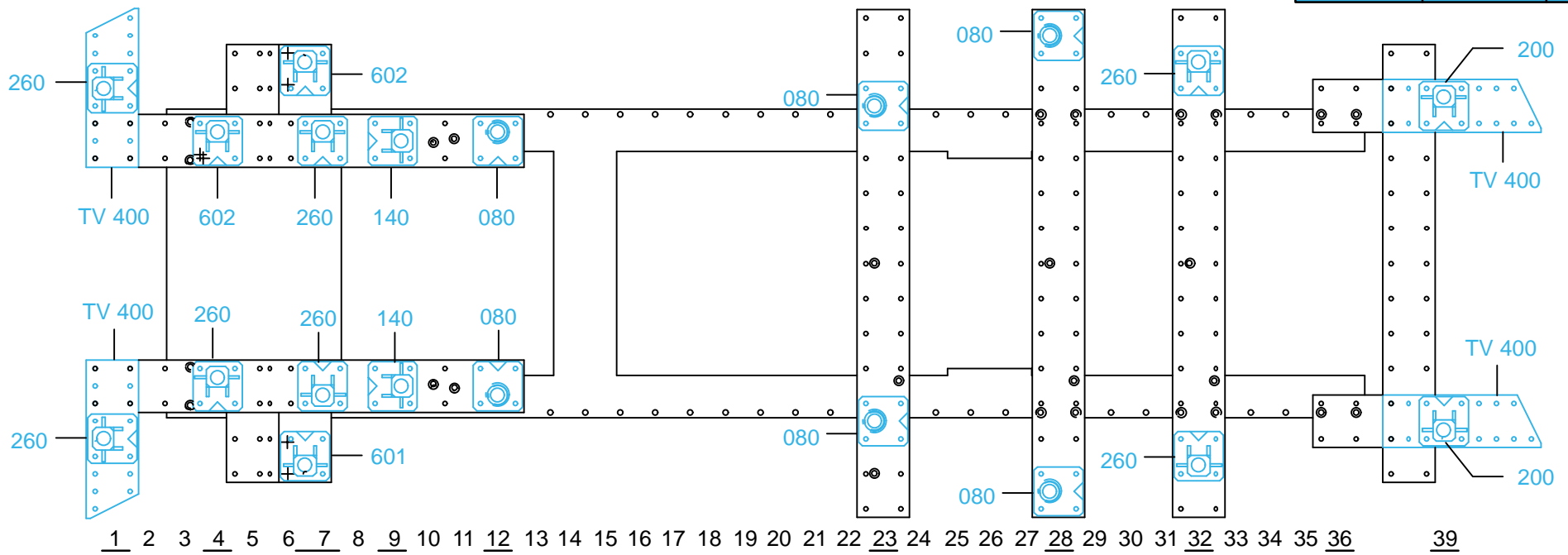

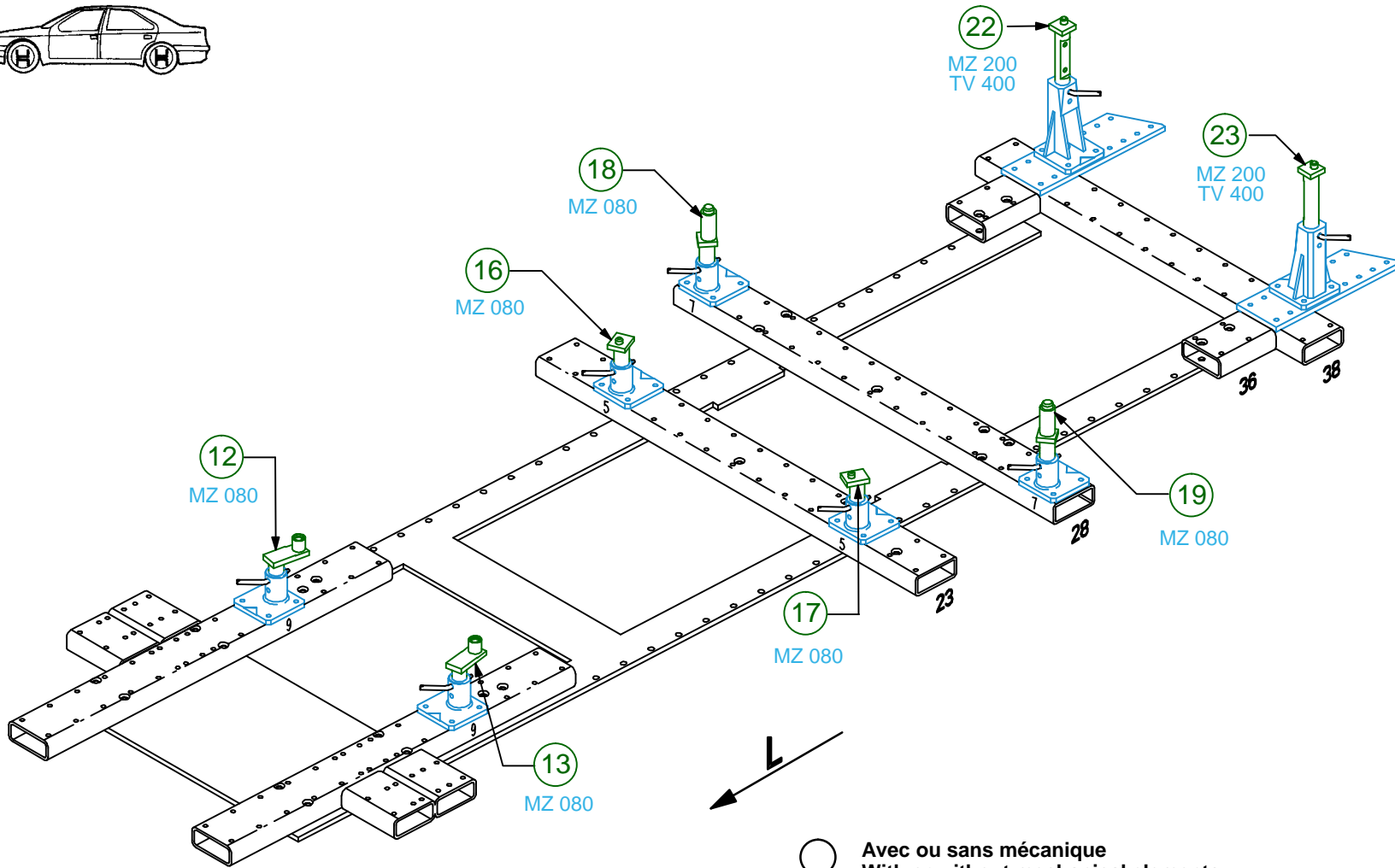
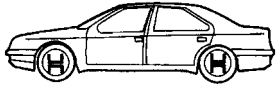

○ Avec ou sans mécanique
 With or without mechanical elements
 Con o senza parti meccaniche
 Mit oder ohne Aggregate
 Con ó sin mecánica desmontada

RENAULT

864.310

88 Kg | 25.11.2005 | 427-D-25H

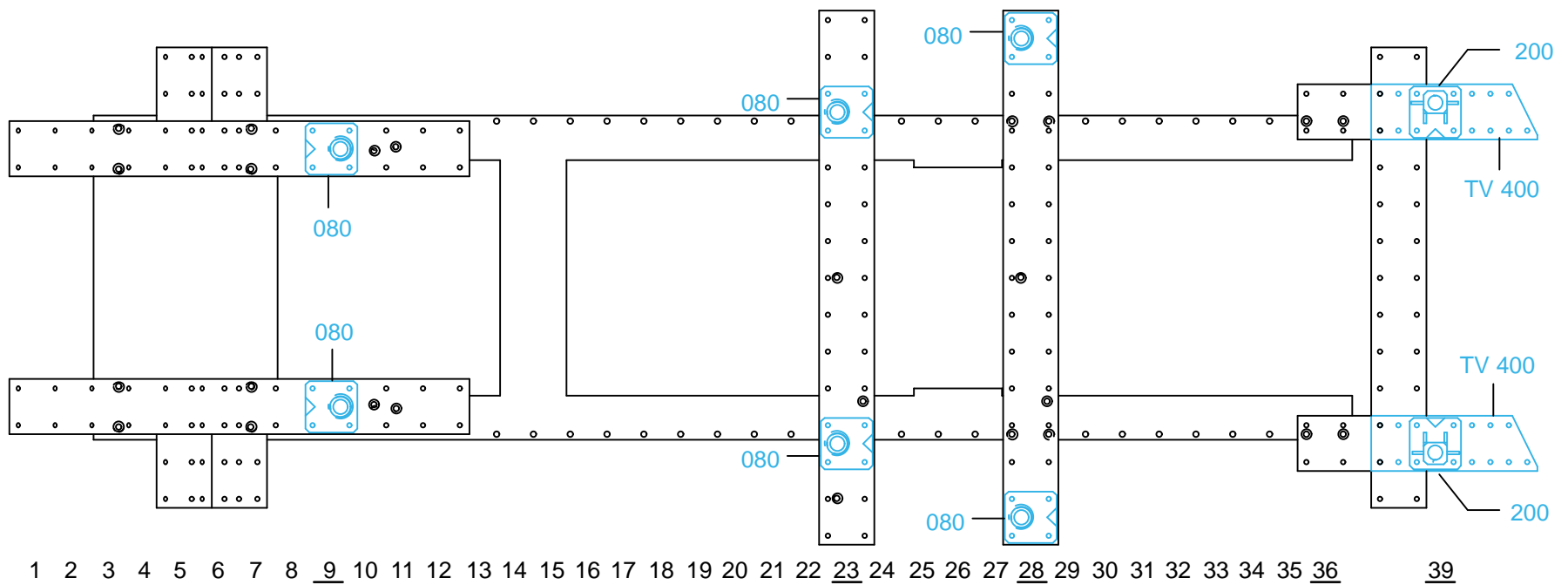

1 2 3 4 5 6 7 8 9 10 11 12 13 14 15 16 17 18 19 20 21 22 23 24 25 26 27 28 29 30 31 32 33 34 35 36 39

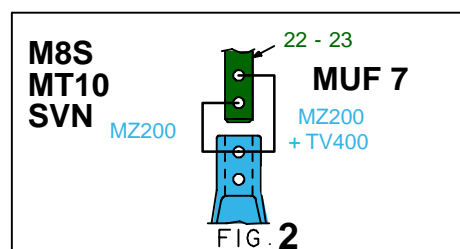
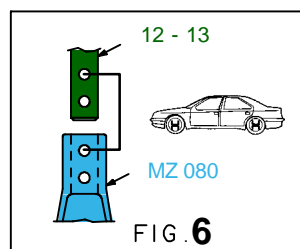
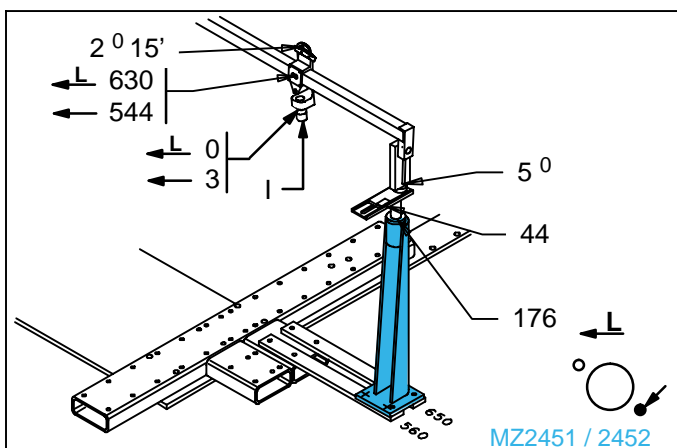

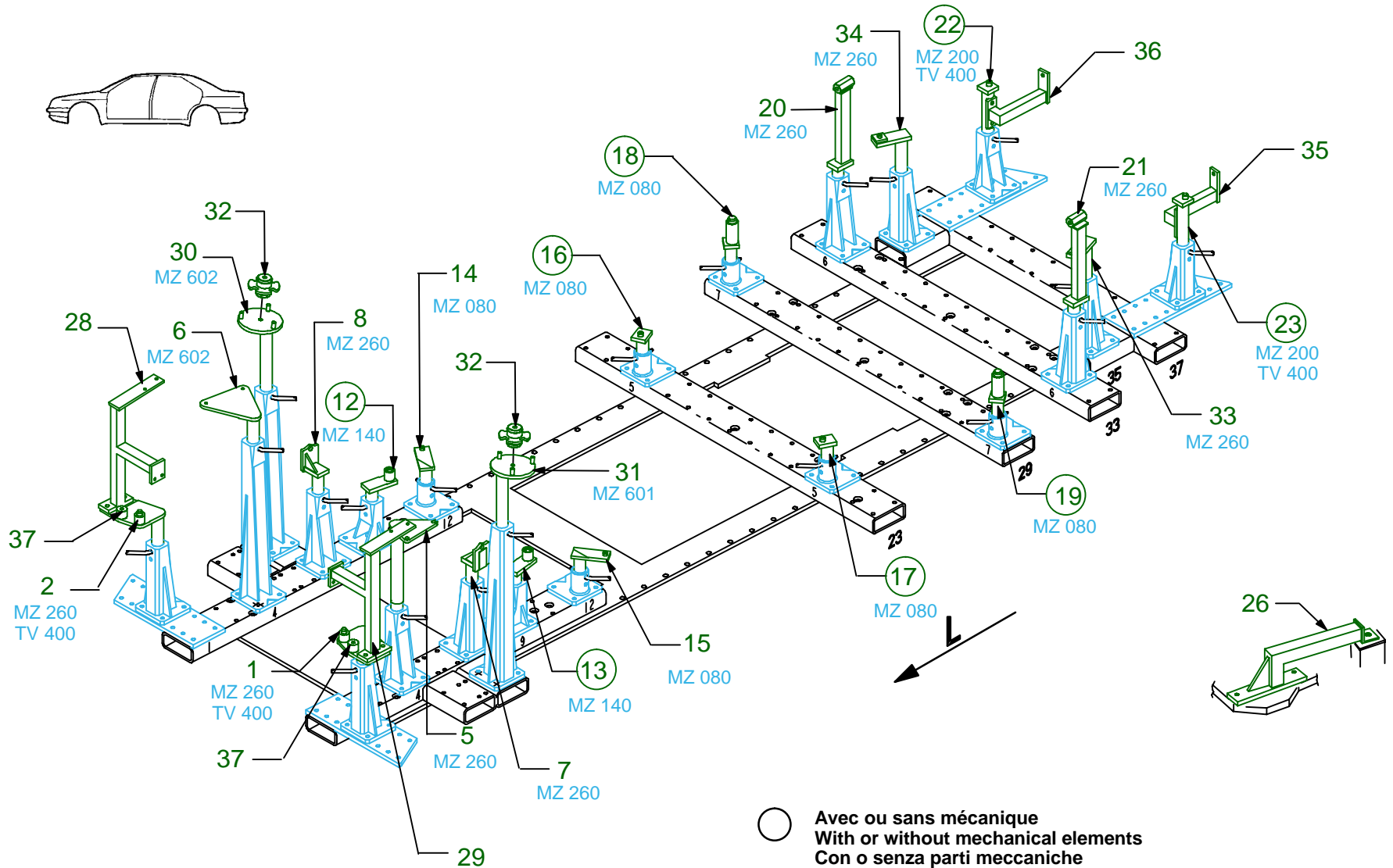

○ Avec ou sans mécanique
 With or without mechanical elements
 Con o senza parti meccaniche
 Mit oder ohne Aggregate
 Con ó sin mecanica desmontada

RENAULT

864.310

88 Kg 27.12.2001 427-D-25K

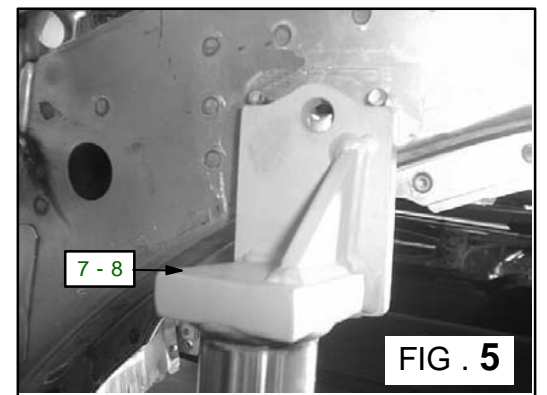
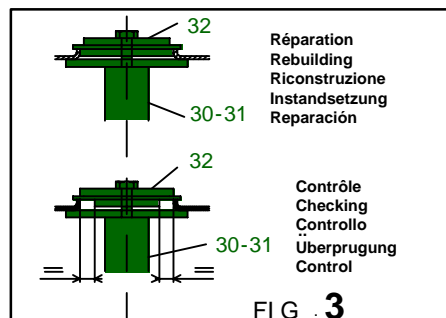
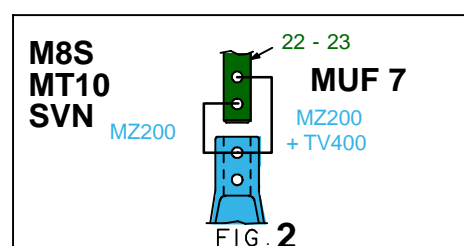
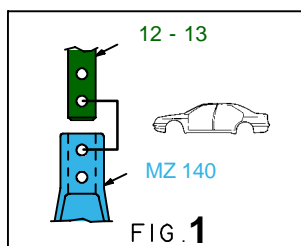
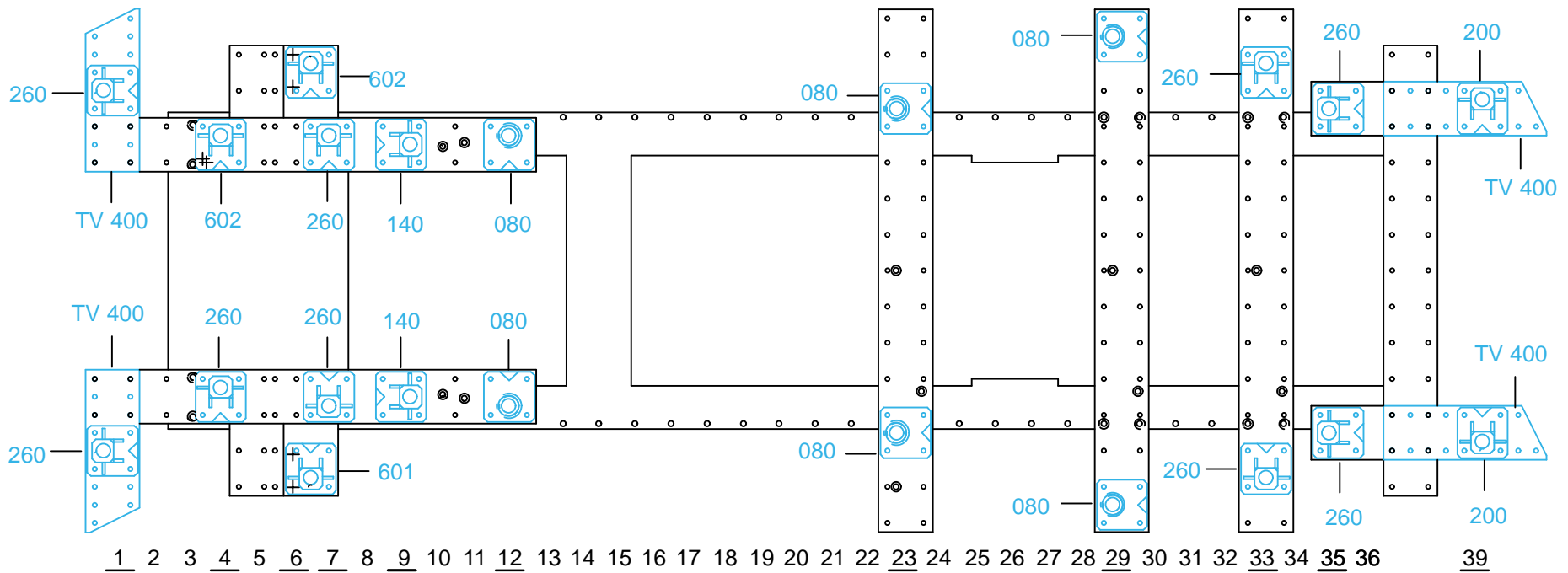

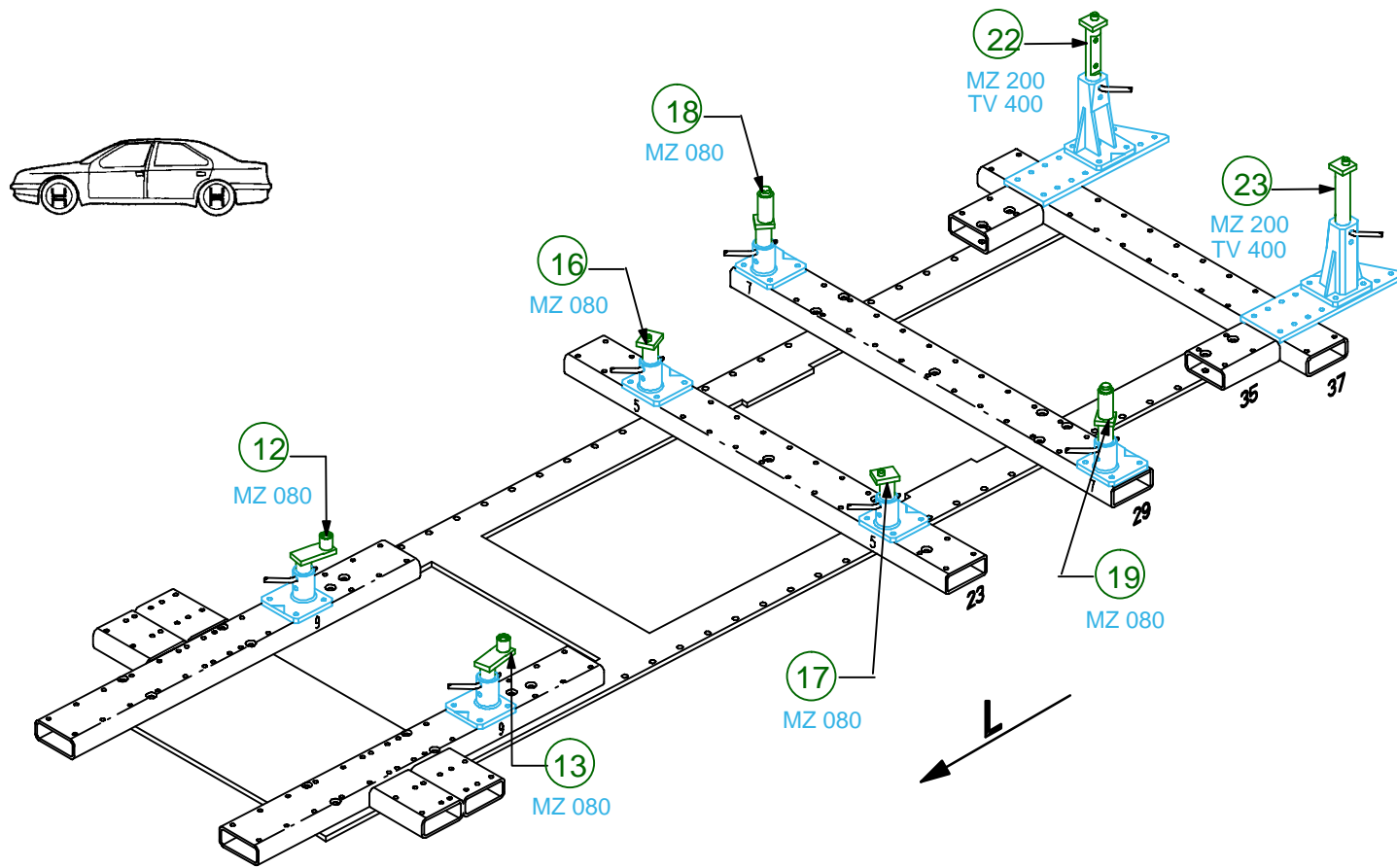

○ Avec ou sans mécanique
 With or without mechanical elements
 Con o senza parti meccaniche
 Mit oder ohne Aggregate
 Con ó sin mecánica desmontada

RENAULT

864.310

88 Kg | 27.12.2001 | 427-D-25L

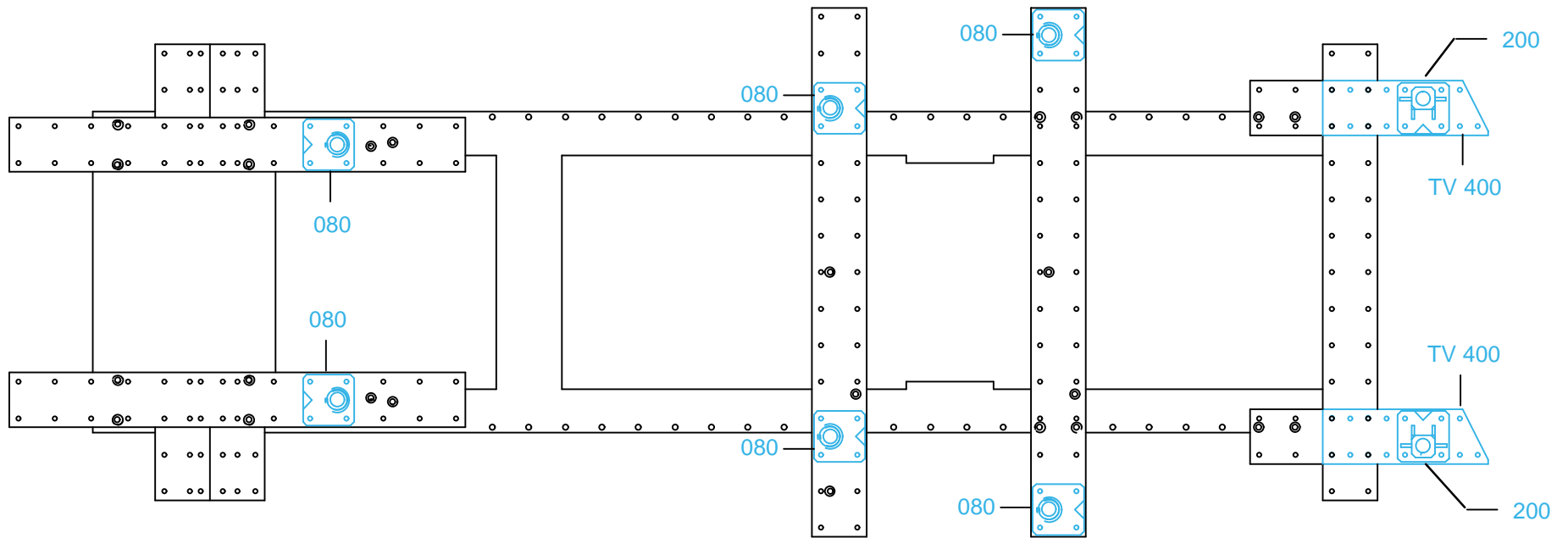

1 2 3 4 5 6 7 8 9 10 11 12 13 14 15 16 17 18 19 20 21 22 23 24 25 26 27 28 29 30 31 32 33 34 35 36 37 38 39 40 41

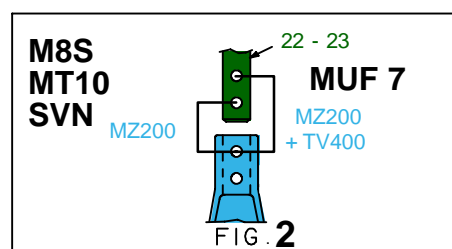
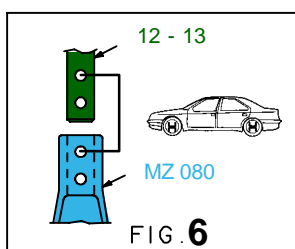
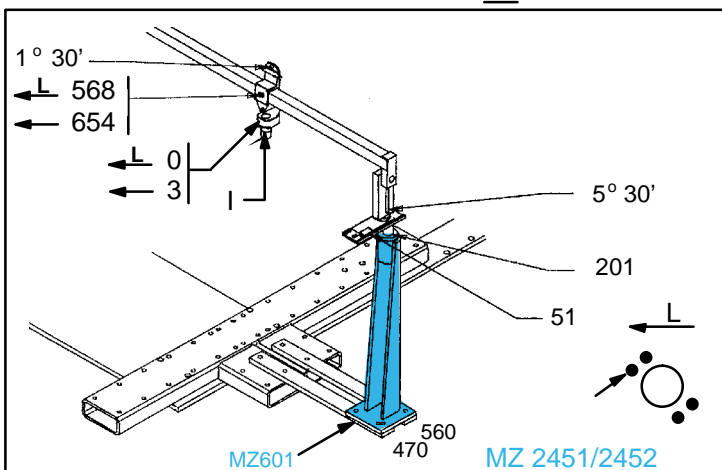

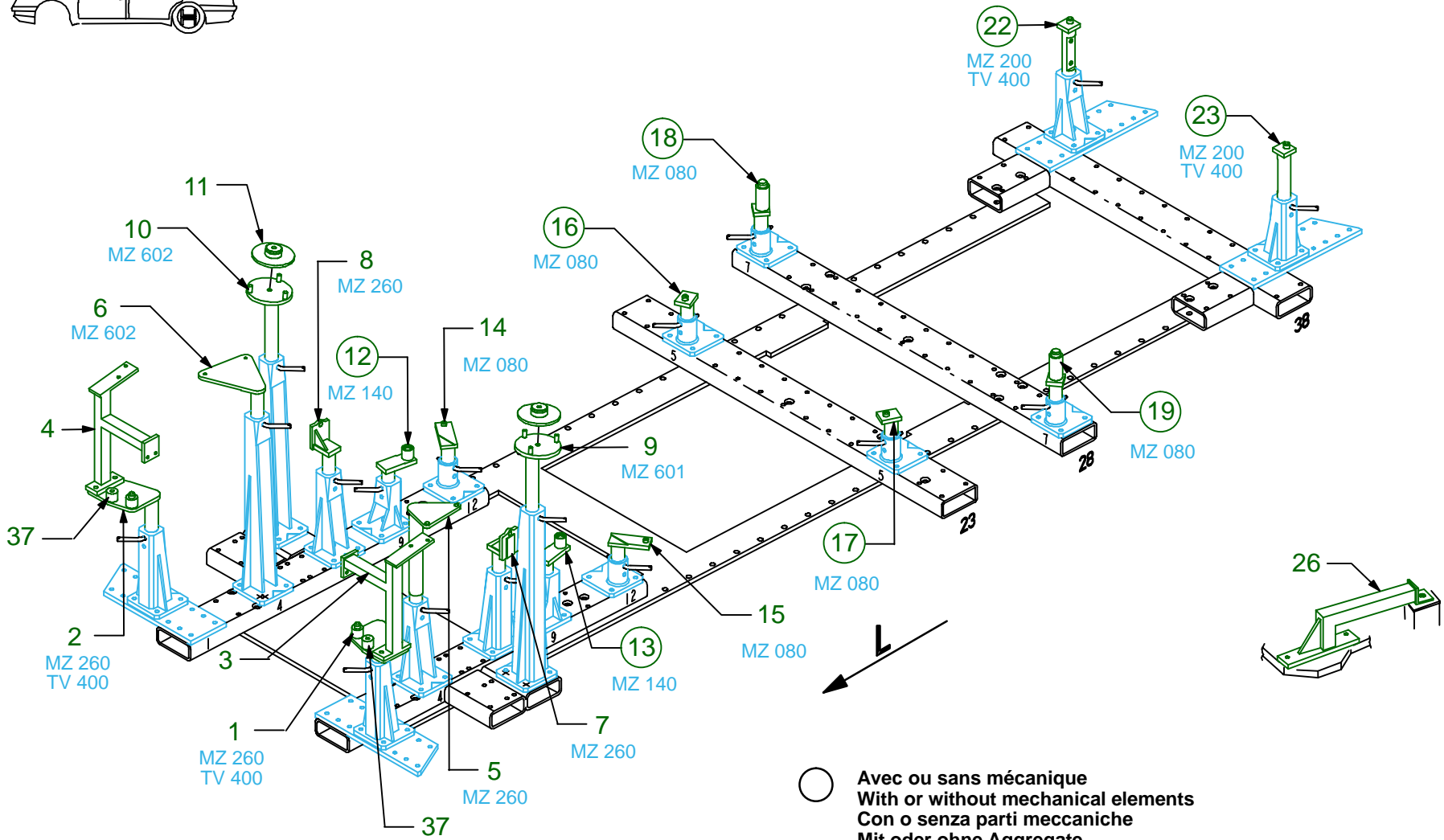

RENAULT

864.310

88 Kg 27.12.2001 427-D-25M

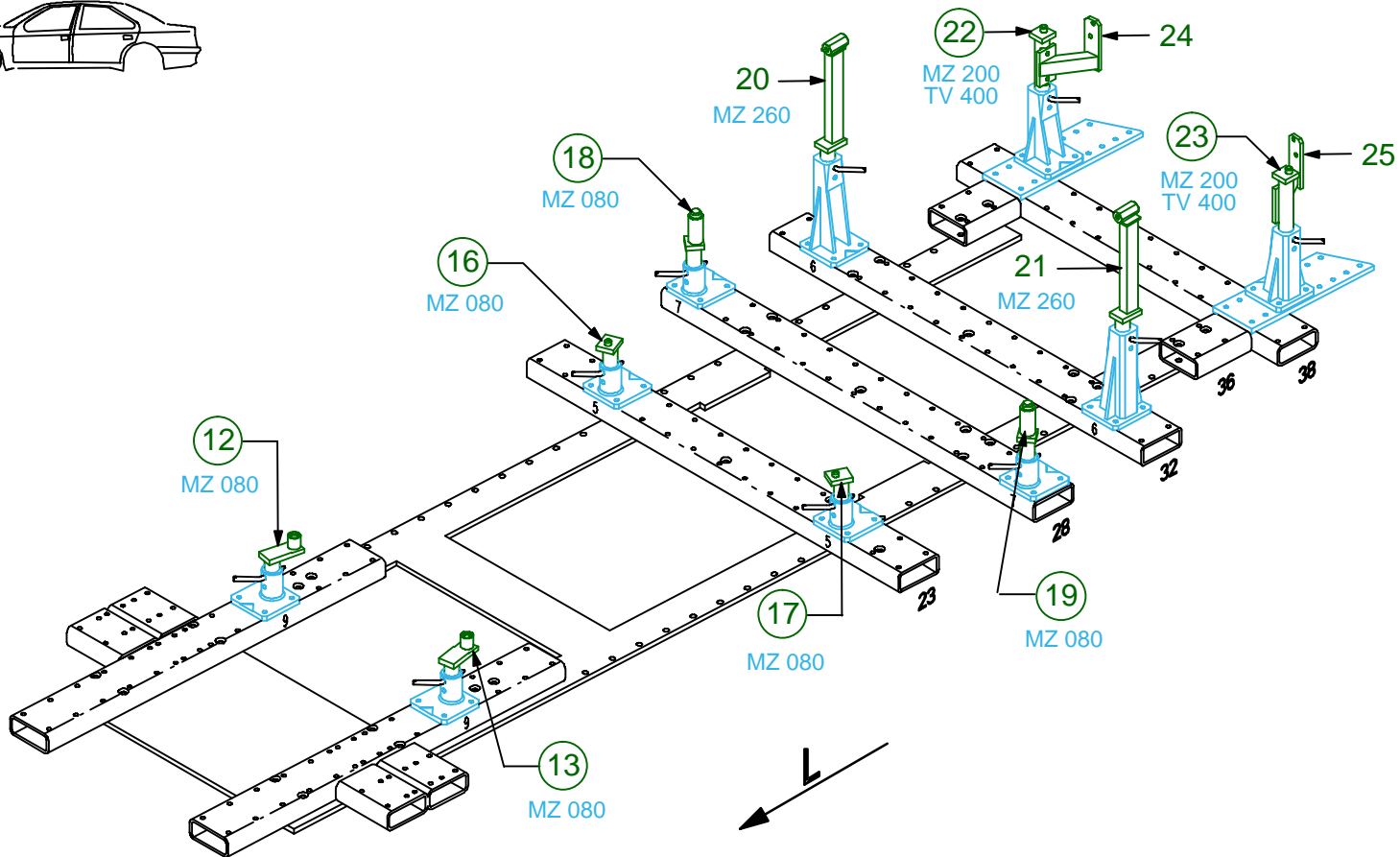
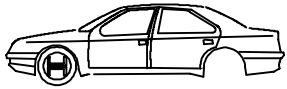

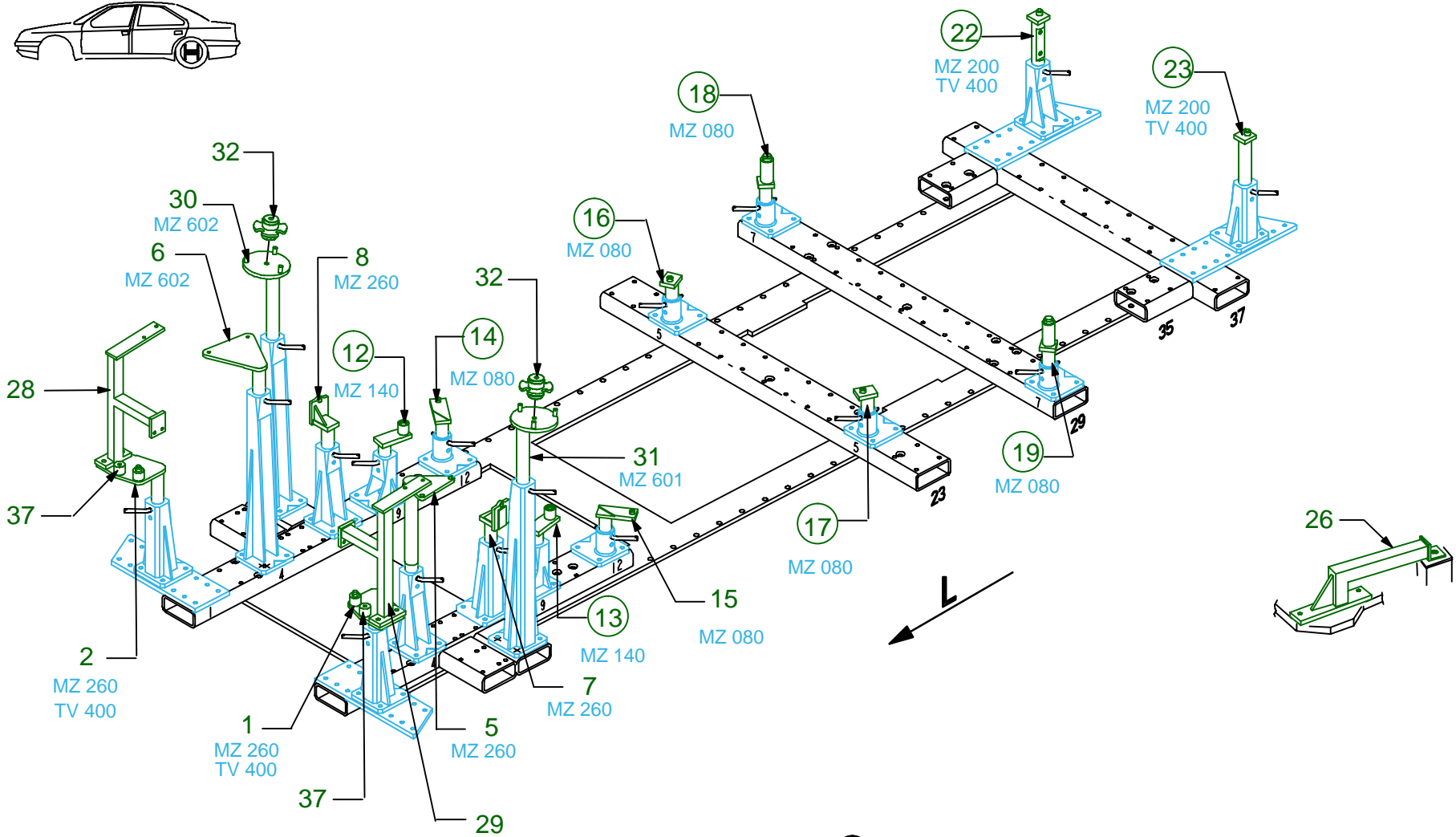
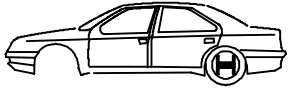

○ Avec ou sans mécanique
 With or without mechanical elements
 Con o senza parti meccaniche
 Mit oder ohne Aggregate
 Con ó sin mecanica desmontada

RENAULT

864.310

88 Kg 19.03.2002 427-D-25N

