

REP.	REFERENCE	PDS	NB	MZ
38	864.7038	3,4	1	
39	864.7039	3,4	1	
40	864.7040	2,2	1	080
41	864.7041	2,2	1	080
42	864.7042	1,9	1	260/080
43	864.7043	1,9	1	260/080
44	864.7044	0,8	2	
45	864.7045	0,3	2	
46	864.7046	1,9	1	200
47	864.7047	3,0	1	142
48	864.7048	3,0	1	141
49	864.7049	2,0	1	
50	864.7050	2,0	1	
51	864.7051	1,4	1	260
52	864.7052	1,4	1	260
53	864.7053	0,02	4	
54	864.7054	0,1	2	
55	864.7055	3,2	1	200
56	864.7056	3,2	1	200
57	864.7057	0,8	2	
58	864.7058	2,8	3	
59	864.7059	1,0	1	

M 10-20	4
M 10-25	2
M 10-35	4
M 12-25	12
M 12-30	8
M 16-30	2
CHc TB 12-25	12
M 16	2

complément au
complementary set to
complemento al
zusatz zu **864.310**

○ Avec ou sans mécanique
With or without mechanical elements
Con o senza parti meccaniche
Mit oder ohne Aggregate
Con ó sin mecanica desmontada

RENAULT

864.308

51 Kg 09.04.2002 427-D-29A

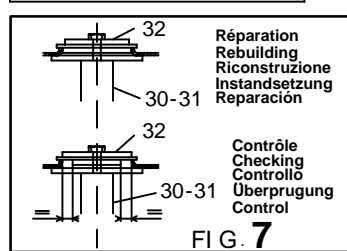
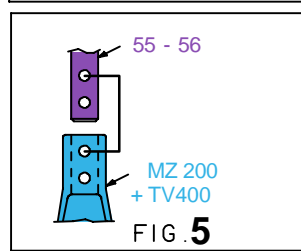
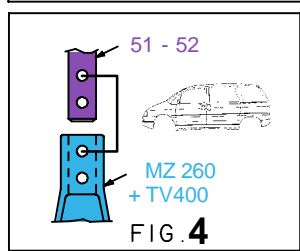
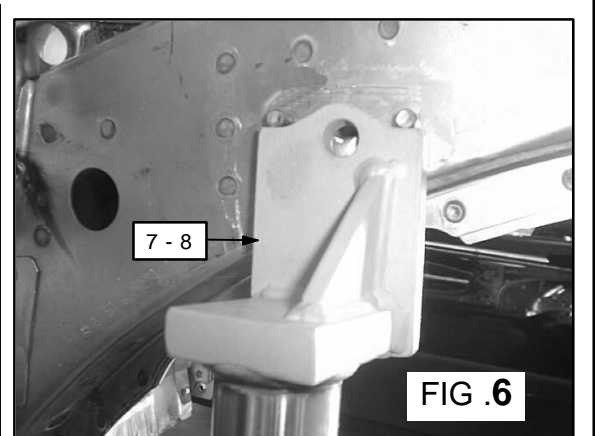
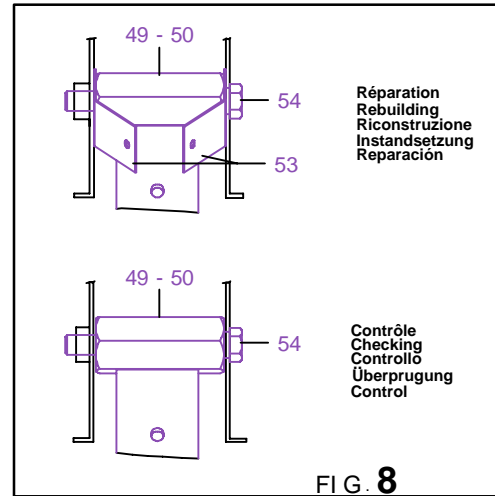
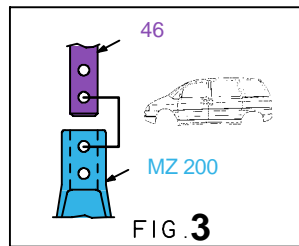
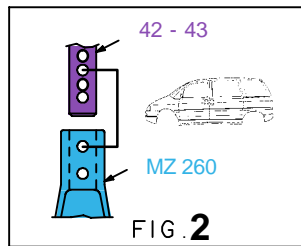
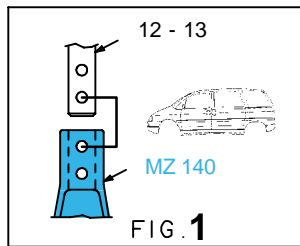
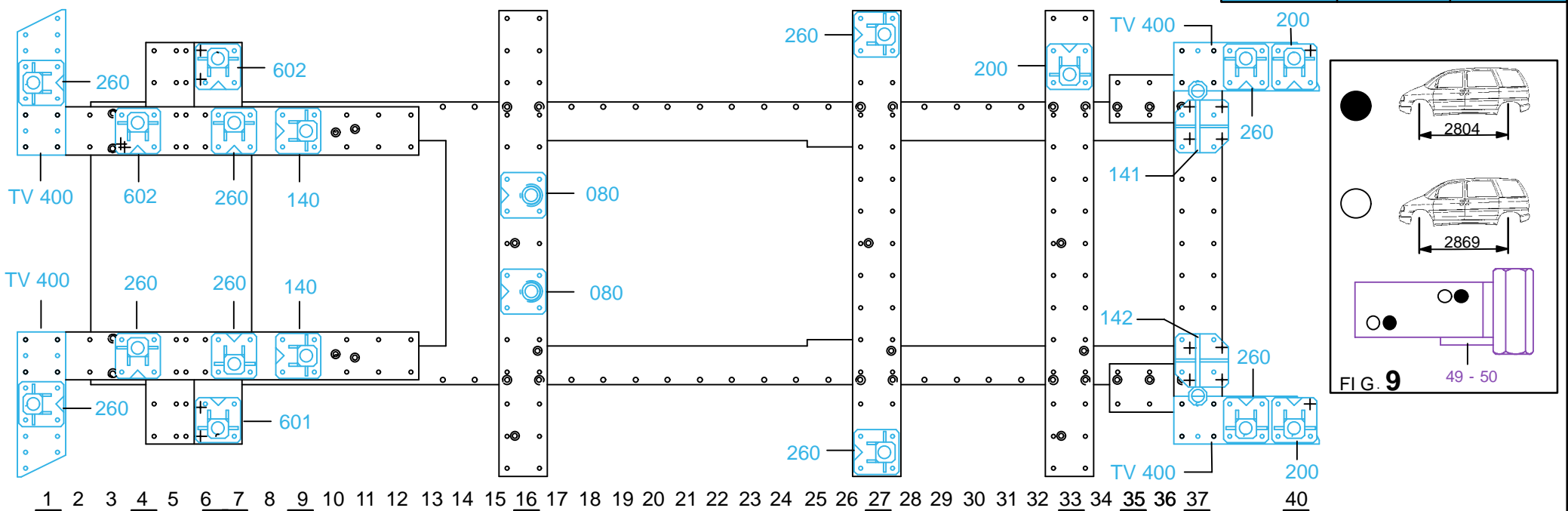

864.308-RVA3-1 00

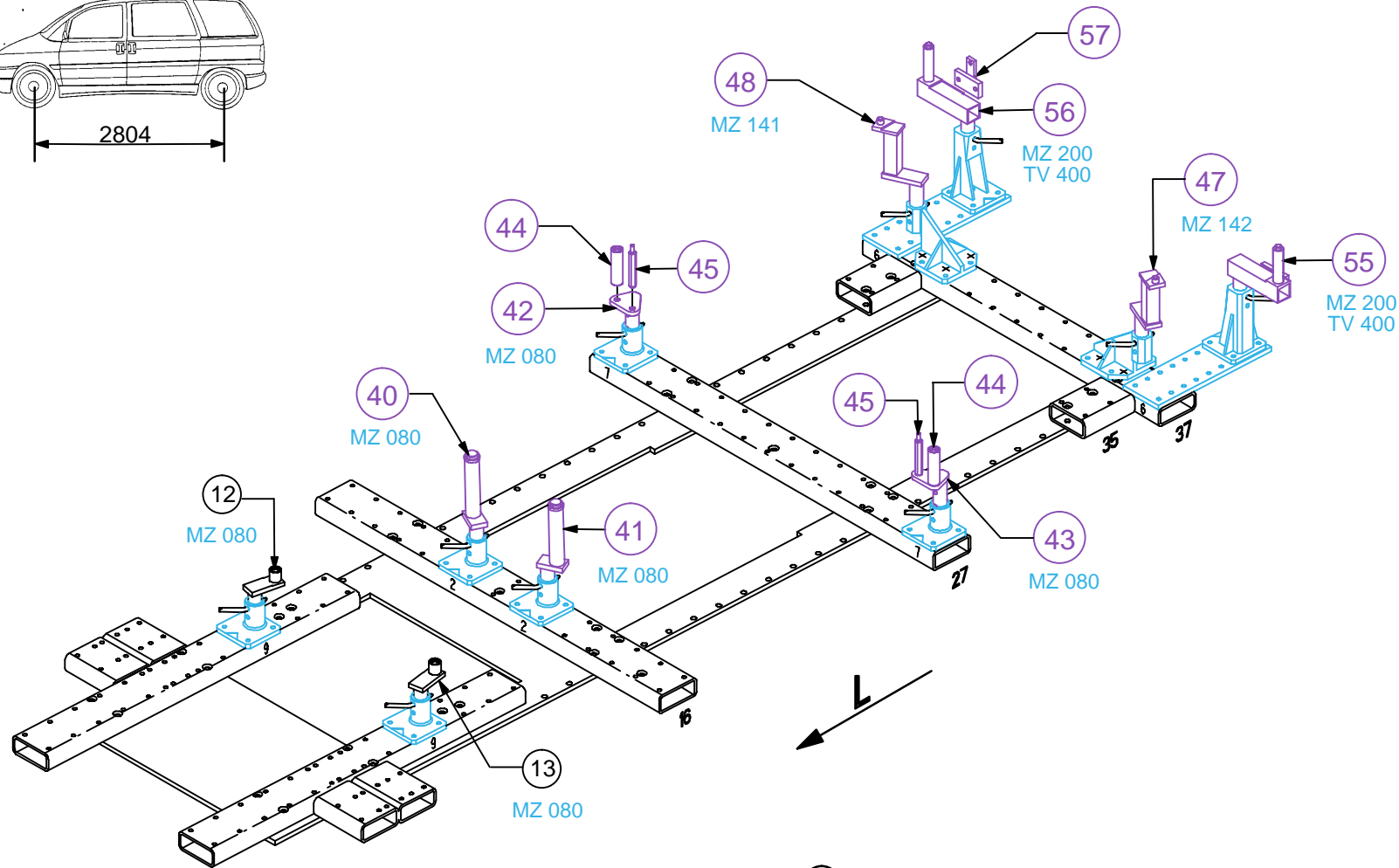
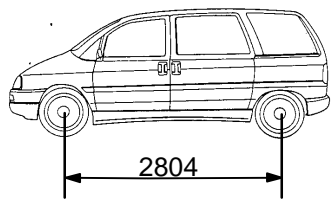

○ Avec ou sans mécanique
 With or without mechanical elements
 Con o senza parti meccaniche
 Mit oder ohne Aggregate
 Con ó sin mecánica desmontada

RENAULT

864.308

51 Kg | 09.04.2002 | 427-D-29B

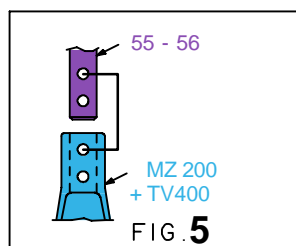
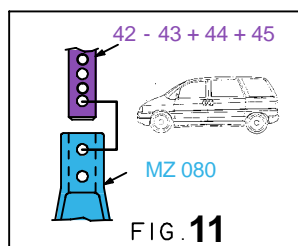
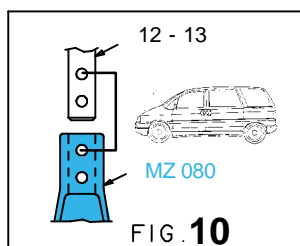
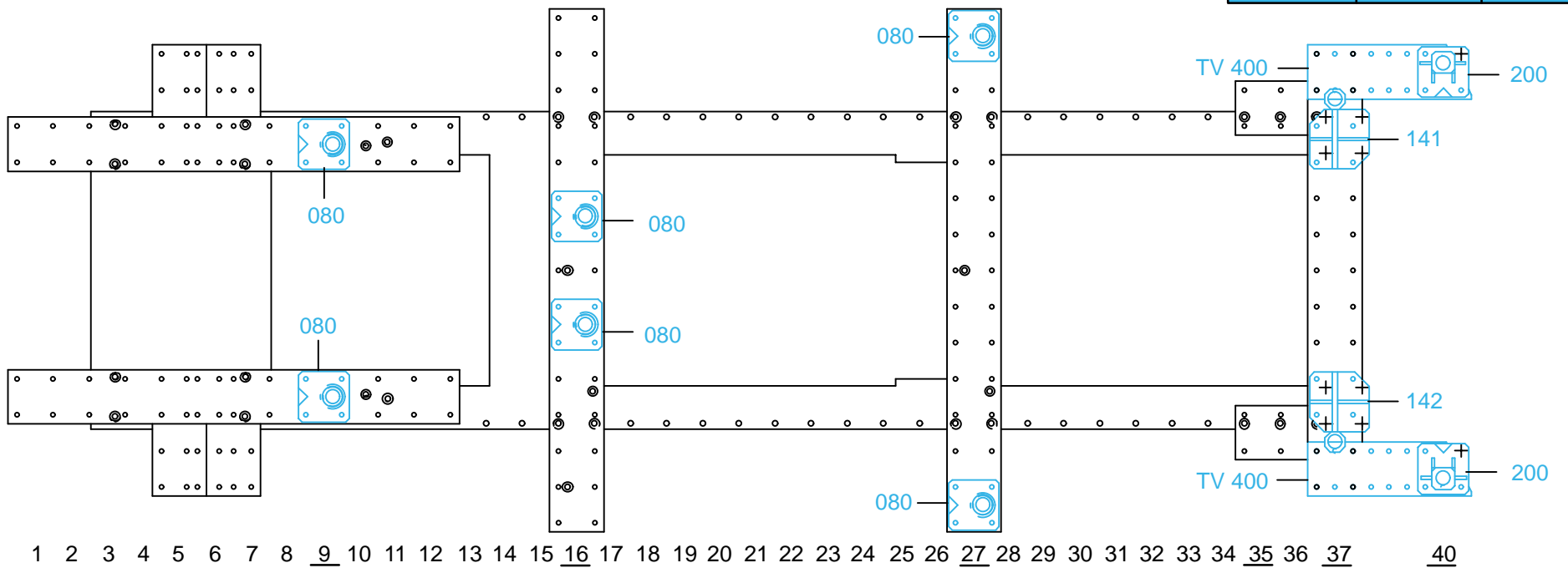

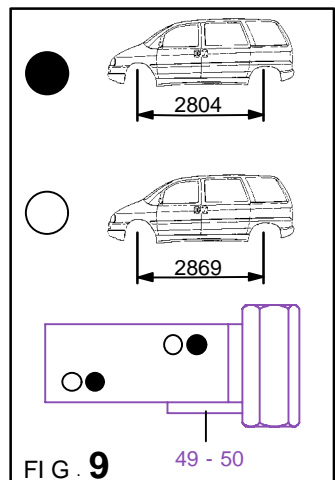
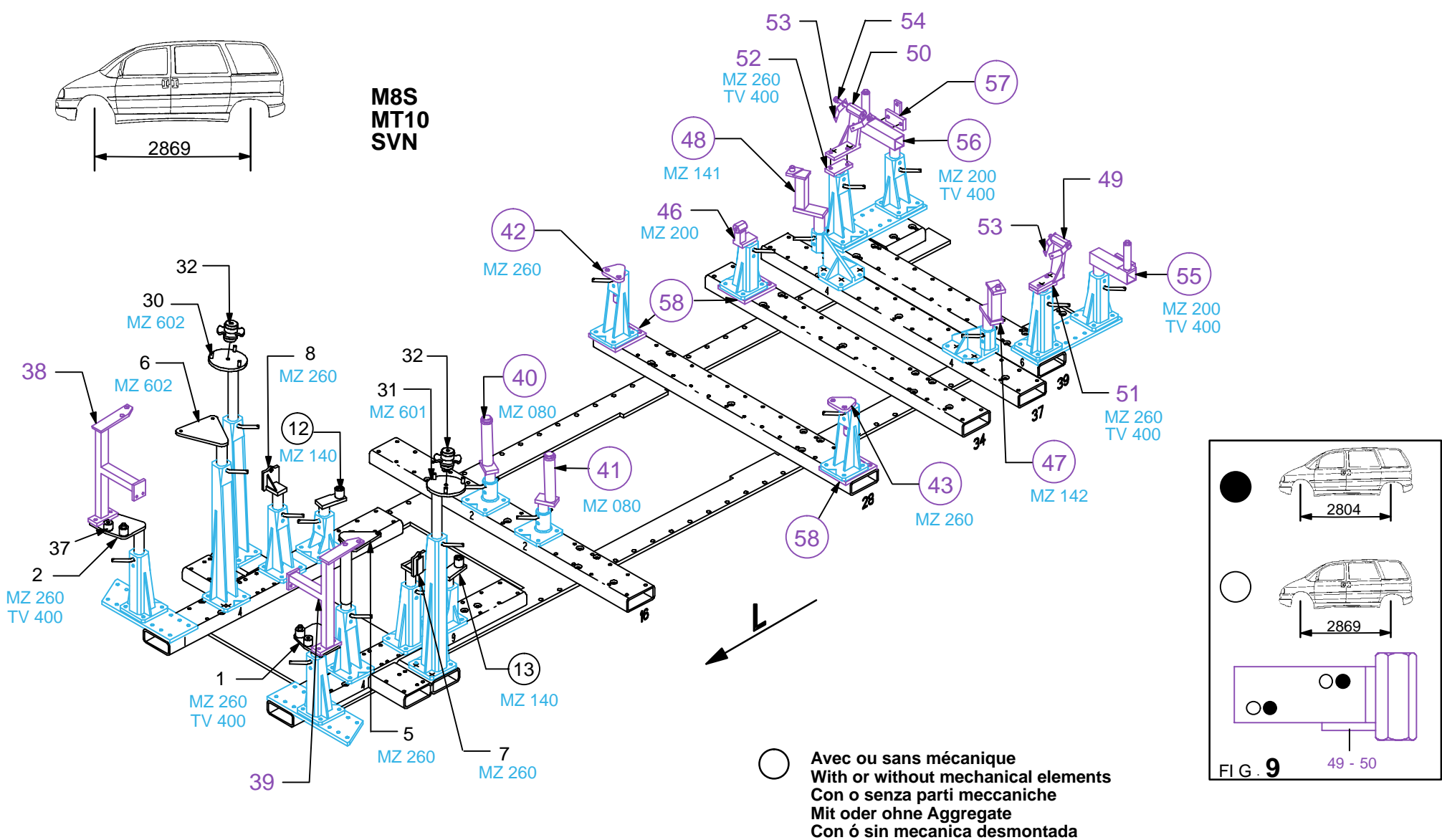

RENAULT

864.308

51 Kg	09.04.2002	427-D-29C
-------	------------	-----------

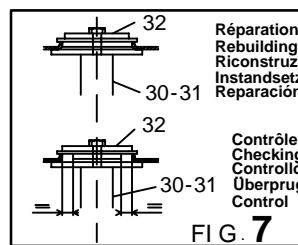
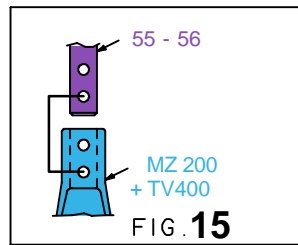
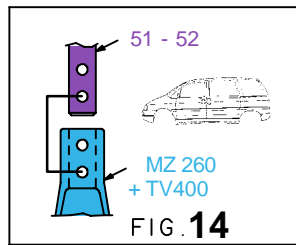
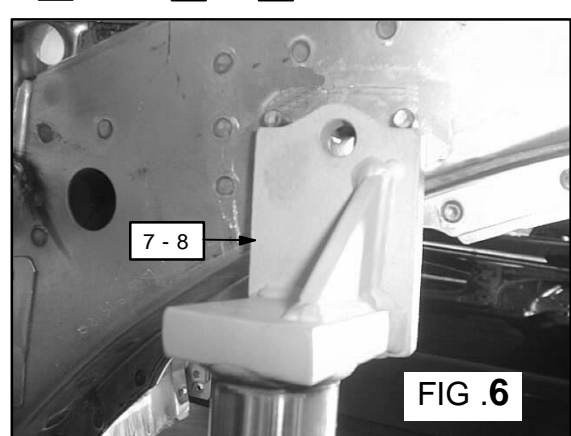
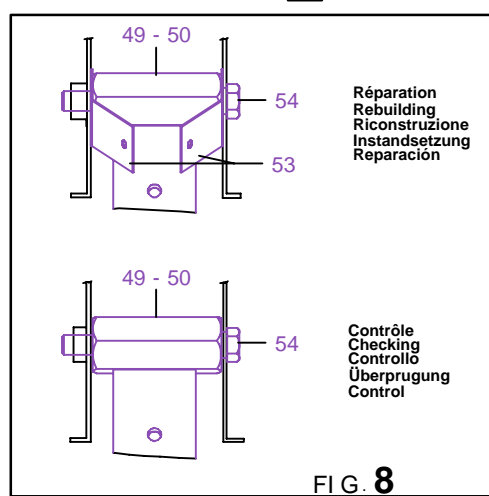
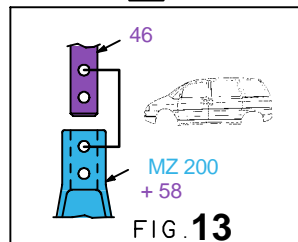
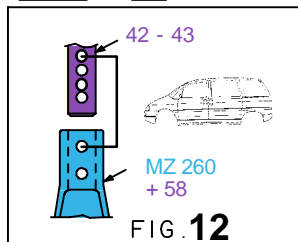
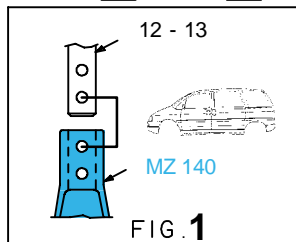
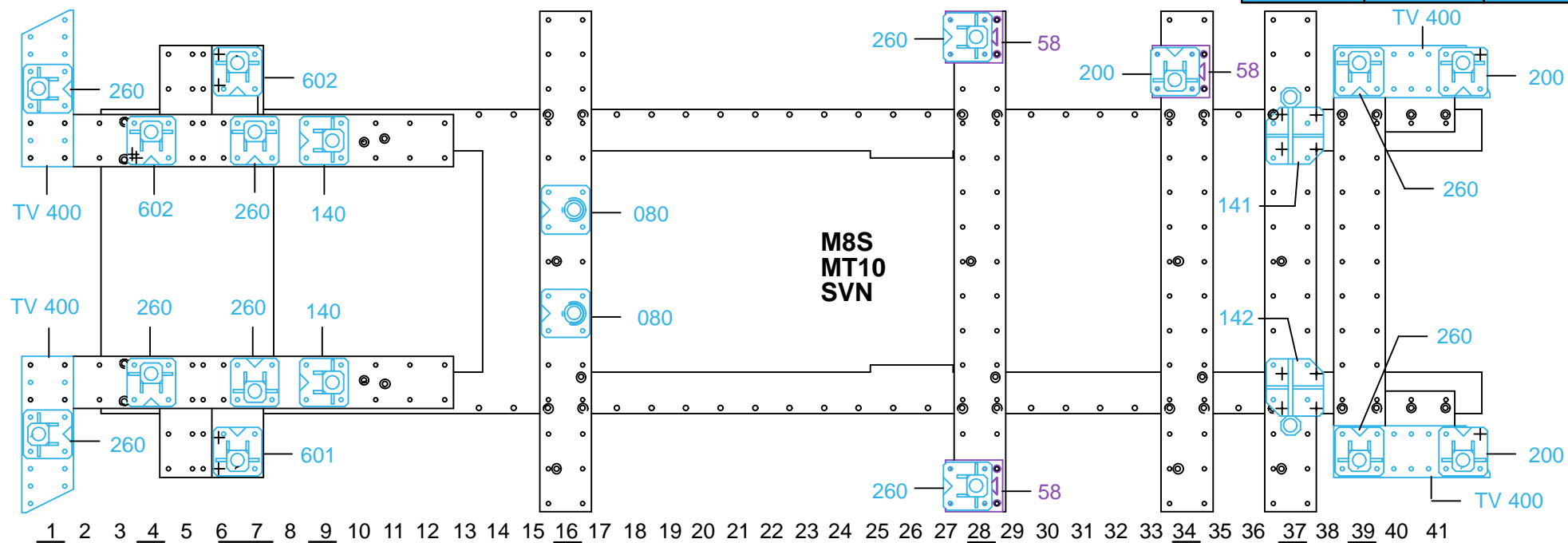

864.308-RVA3-2 | 00

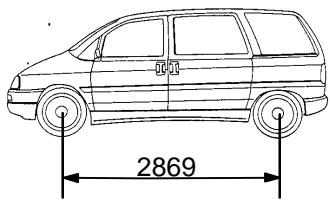

**M8S
MT10
SVN**

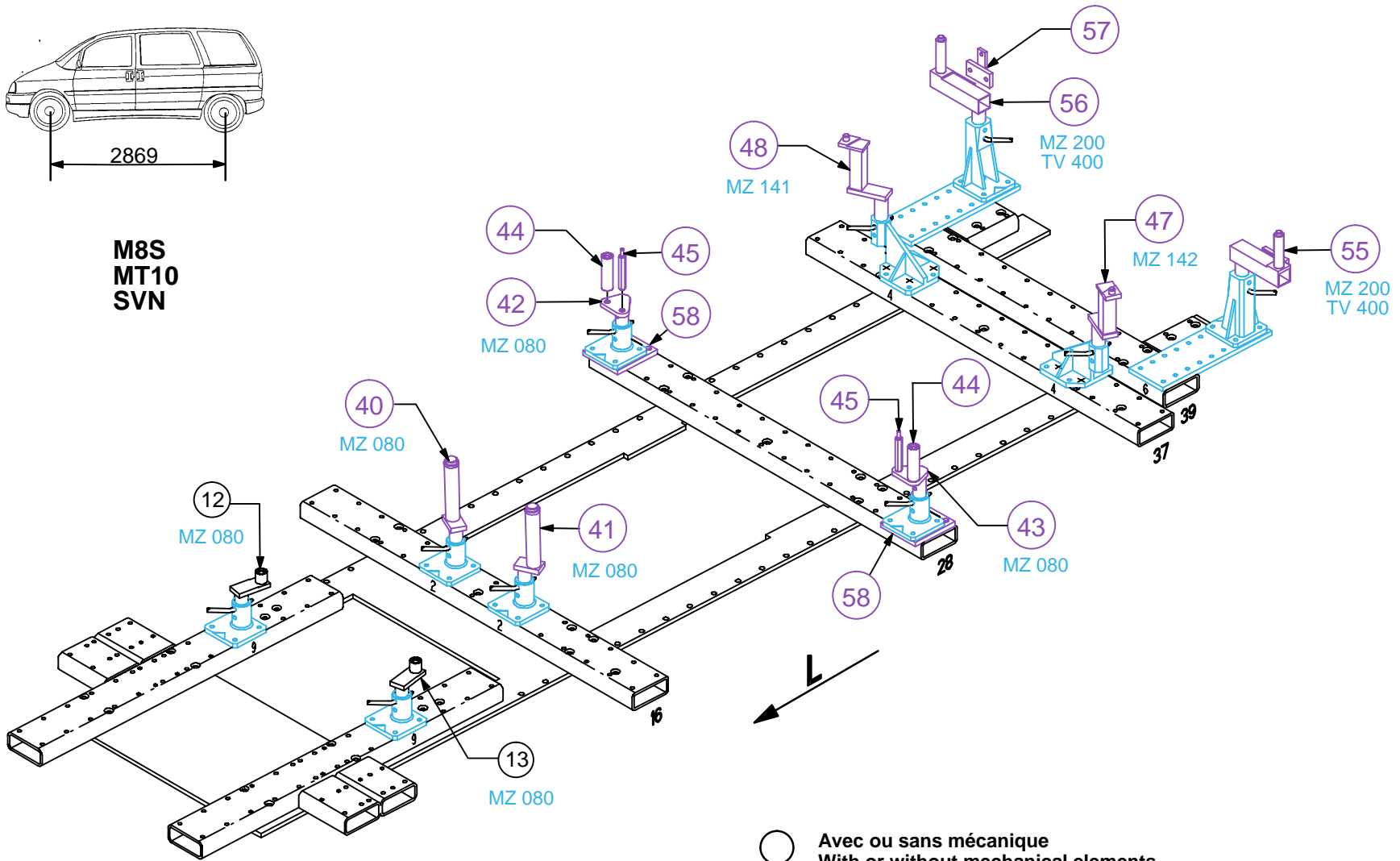

○ Avec ou sans mécanique
With or without mechanical elements
Con o senza parti meccaniche
Mit oder ohne Aggregate
Con ó sin mecanica desmontada

RENAULT

864.308

51 Kg | 09.04.2002 | 427-D-29D

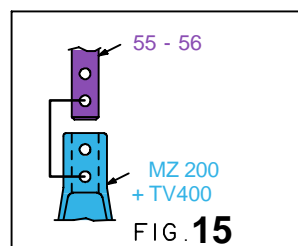
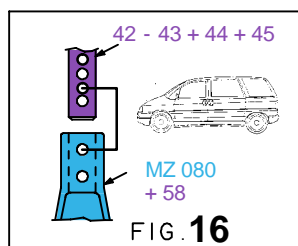
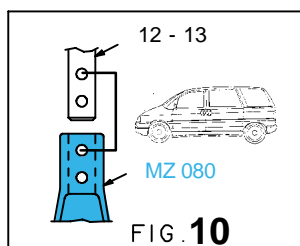
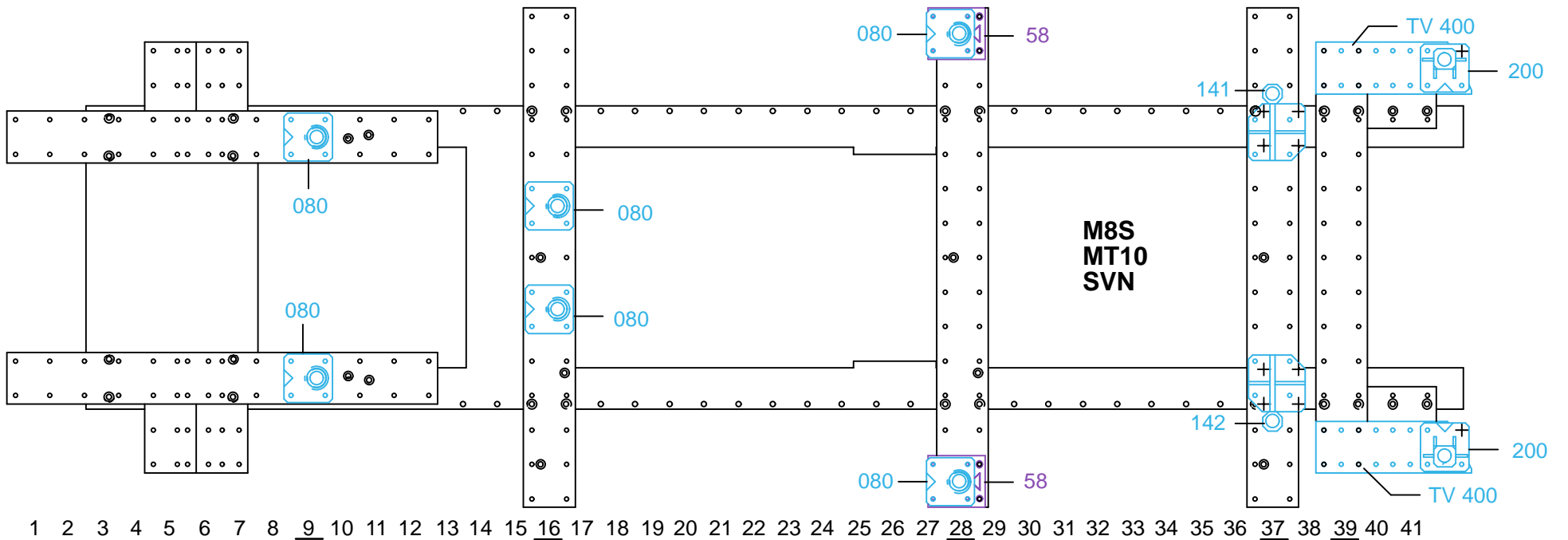

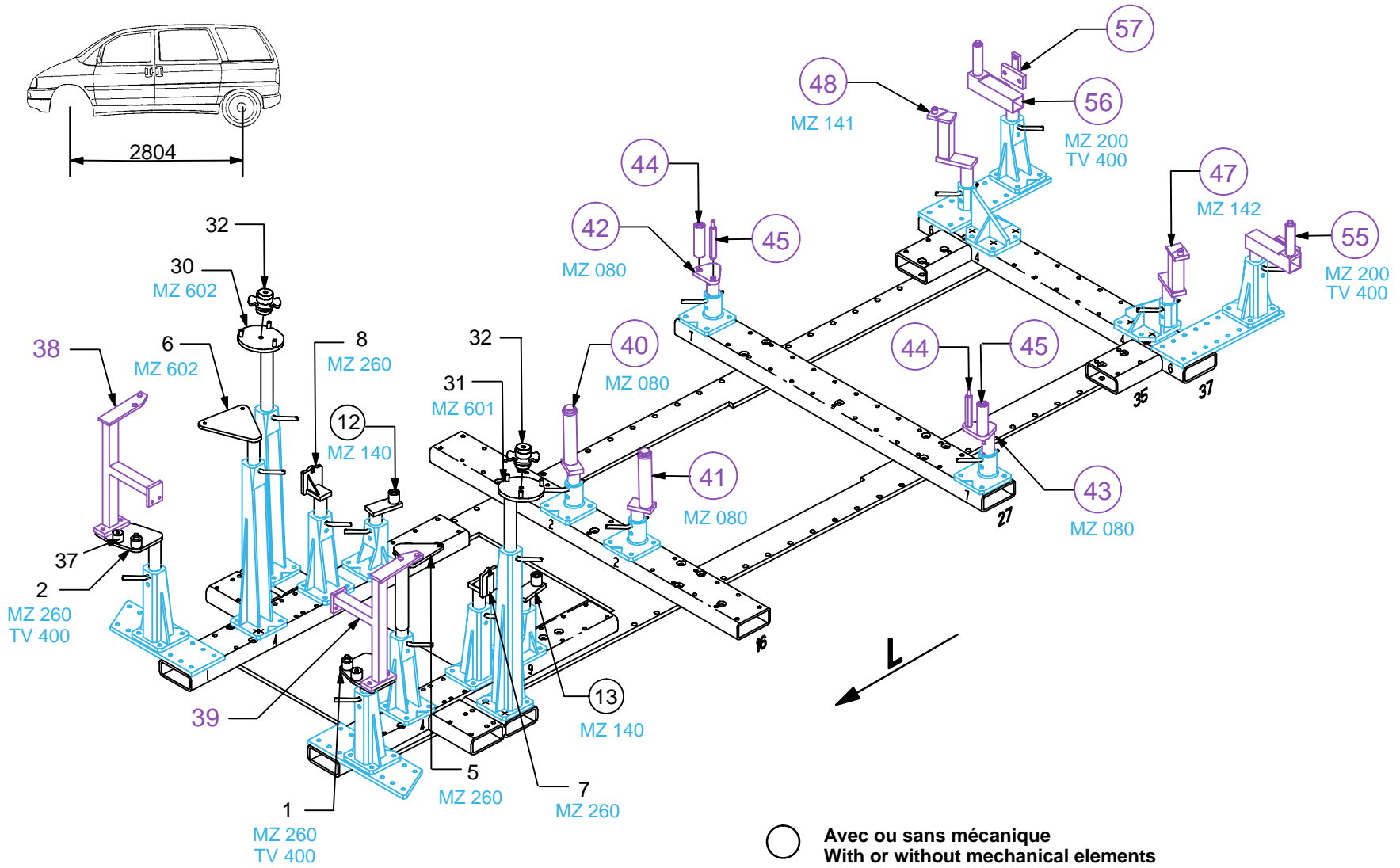

○ Avec ou sans mécanique
 With or without mechanical elements
 Con o senza parti meccaniche
 Mit oder ohne Aggregate
 Con ó sin mecanica desmontada

RENAULT

864.308

51 Kg | 09.04.2002 | 427-D-29E

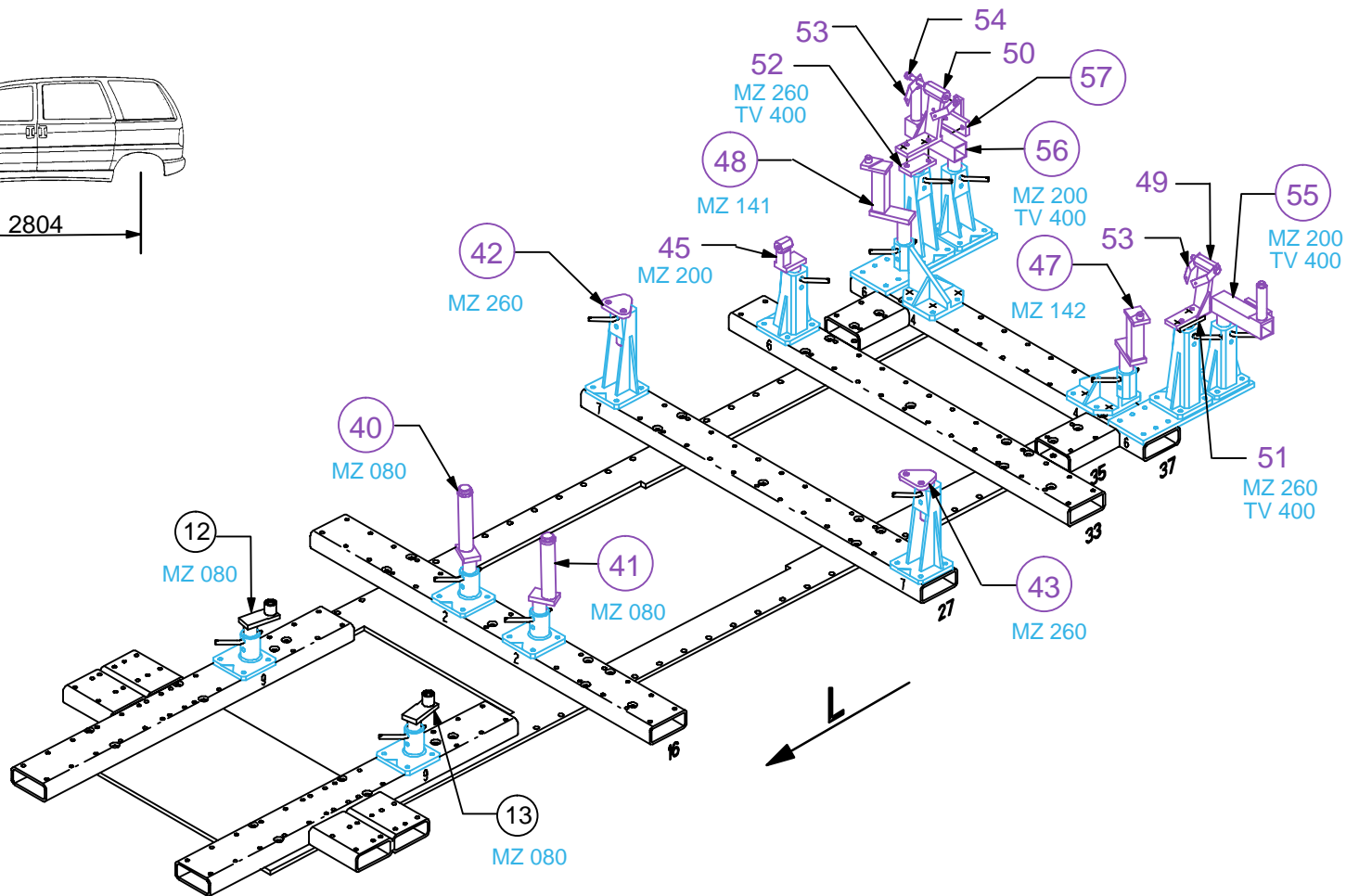
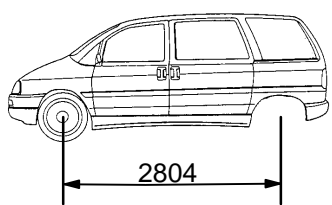

864.308-RVA3-3 | 00

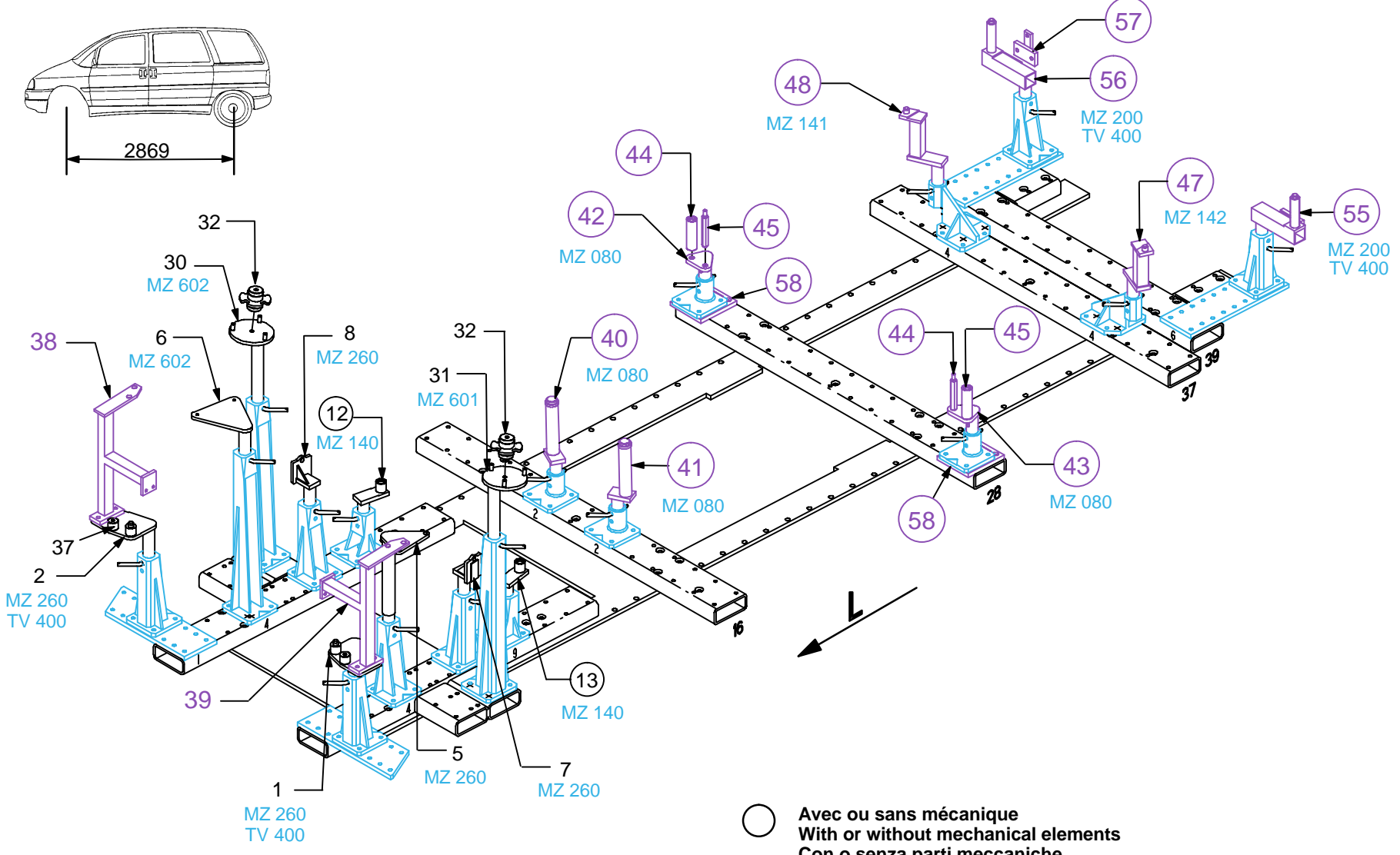

○ Avec ou sans mécanique
 With or without mechanical elements
 Con o senza parti meccaniche
 Mit oder ohne Aggregate
 Con ó sin mecánica desmontada

RENAULT

864.308

51 Kg	09.04.2002	427-D-29F
-------	------------	-----------

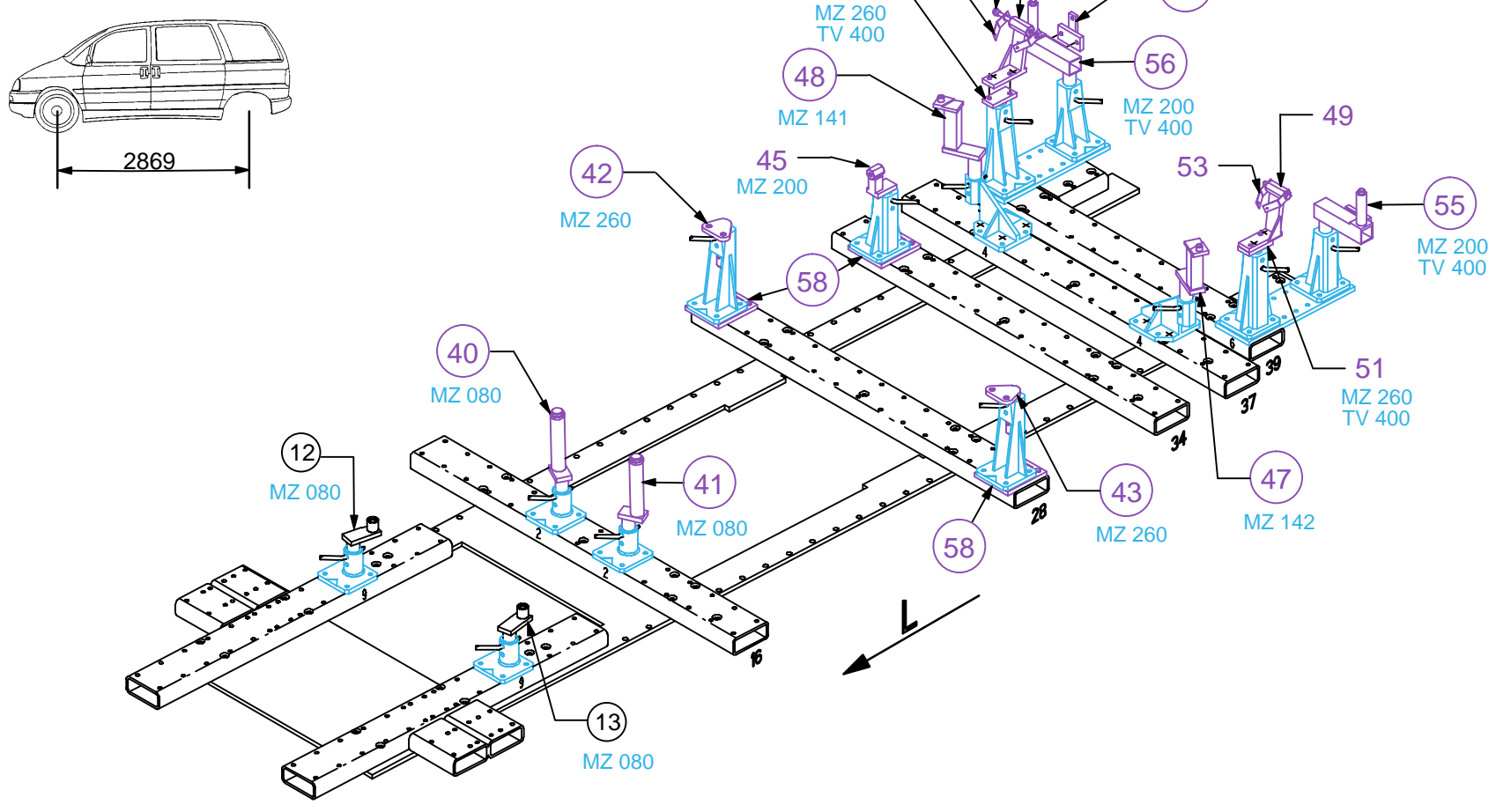

864.308-RVA3-3 00