

REP.	MOD.
20 - 21	V70 → N° 458999 XC70 → N° 172999
70 - 71	V70 N° 459000 → XC70 N° 173000 →

REP.	REFERENCE	PDS	NB	MZ
5	784.7005	1,6	1	141
6	784.7006	1,6	1	142
7	784.7007	0,4	4	
8	784.7008	0,08	4	
11	784.7011	0,6	2	
12	784.7012	1,6	1	080
13	784.7013	1,6	1	080
14	784.7014	1,7	1	080
15	784.7015	1,7	1	080
16	784.7016	1,6	1	080
17	784.7017	1,6	1	080
20	784.7020	0,4	2	
21	784.7021	0,2	2	
26	784.7026	0,8	2	
31	784.7031	3,1	1	200
32	784.7032	3,1	1	200
33	784.7033	2,5	1	
34	784.7034	2,5	1	
35	784.7035	2,4	1	
36	784.7036	2,4	1	
37	784.7037	3,8	1	601
38	784.7038	3,8	1	602
39	784.7039	4,0	1	080
40	784.7040	4,0	1	080
41	784.7041	2,4	1	260
42	784.7042	2,4	1	260
43	784.7043	2,4	1	260/140
44	784.7044	2,4	1	260/140
45	784.7045	3,3	1	140
46	784.7046	3,3	1	140
47	784.7047	2,2	1	
48	784.7048	2,2	1	
49	784.7049	2,4	1	
50	784.7050	2,4	1	
51	784.7051	2,9	8	
52	784.7052	0,04	2	
70	784.7070	0,5	2	
71	784.7071	0,2	2	

○ Avec ou sans mécanique
With or without mechanical elements
Con o senza parti meccaniche
Mit oder ohne Aggregate
Con ó sin mecanica desmontada

VOLVO

M 10-35	4
M 10-40	2
M 10-60	2
M 12-16	4
M 12-25	40
M 12-30	4
M 12-40	2
M 12-65	2
M 12-120	4
M 14-130	4
CHc 12-25 TB	16
M 12	2
MU 12	2

847.310

102 Kg | 25.01.2005 | 439-D-11E

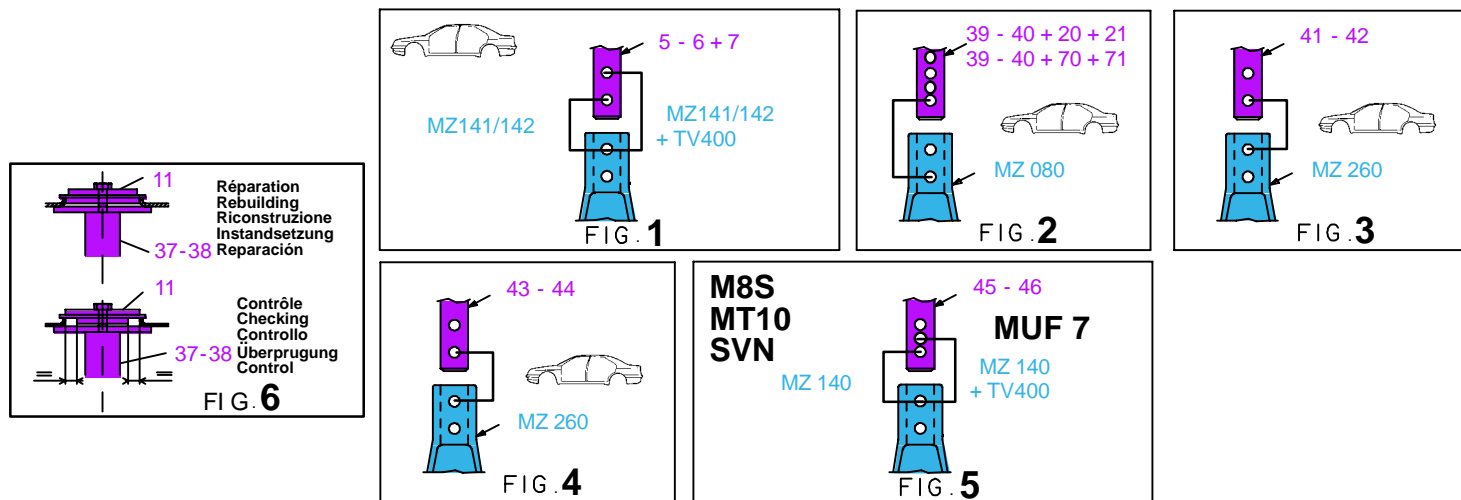
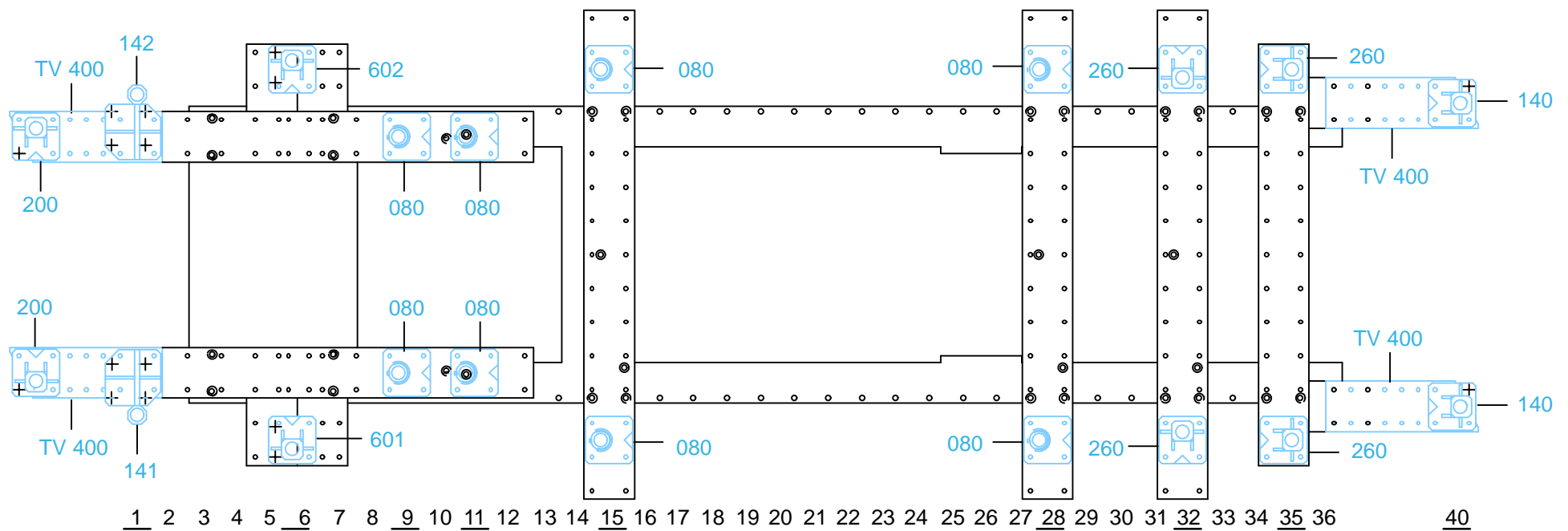

847.310-RVA3-1 | 00

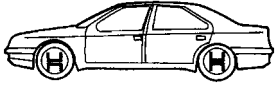

REP.	MOD.
20	V70 → N° 458999 XC70 → N° 172999
70	V70 N° 459000 → XC70 N° 173000 →

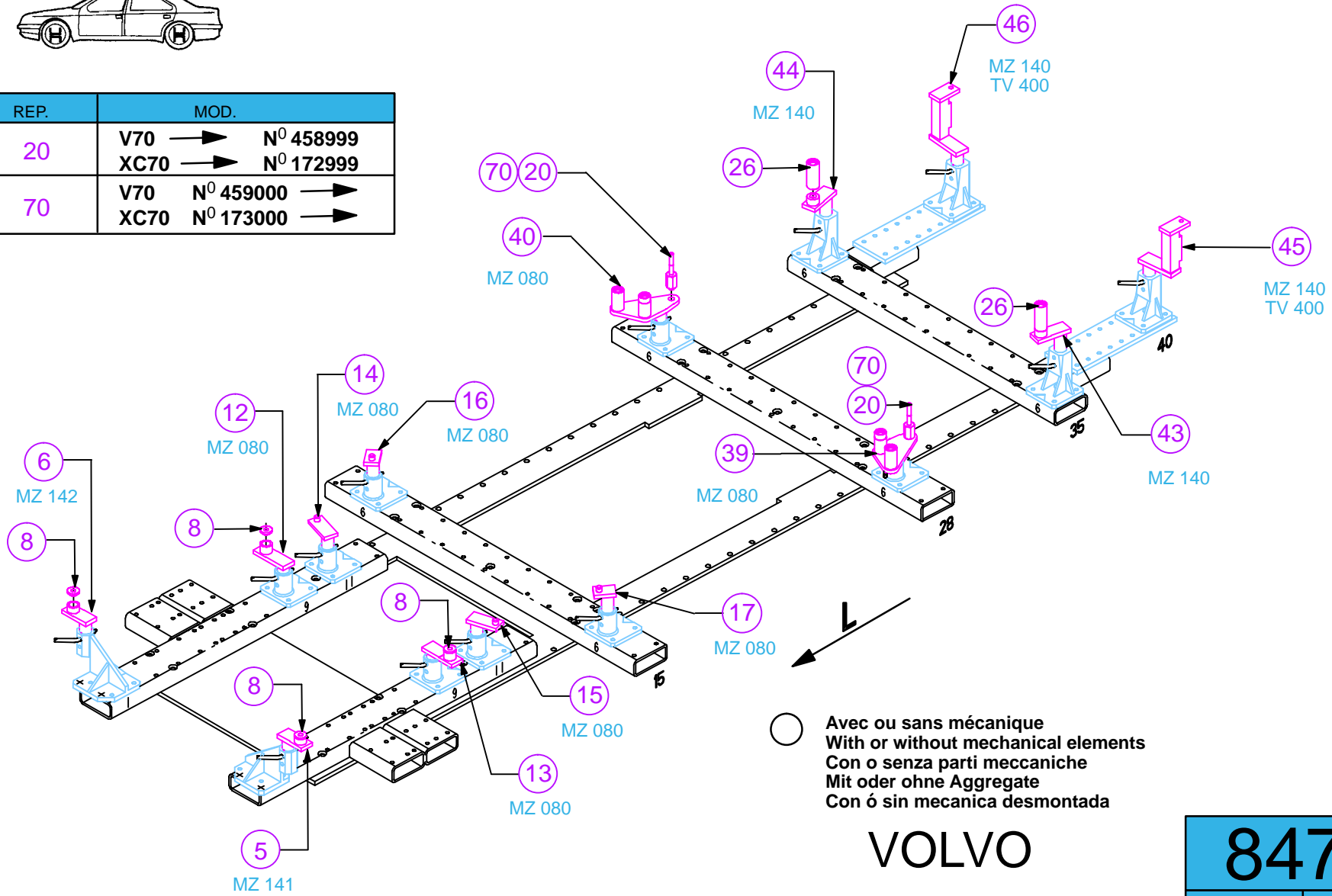

VOLVO

847.310

102 Kg | 25.01.2005 | 439-D-11F

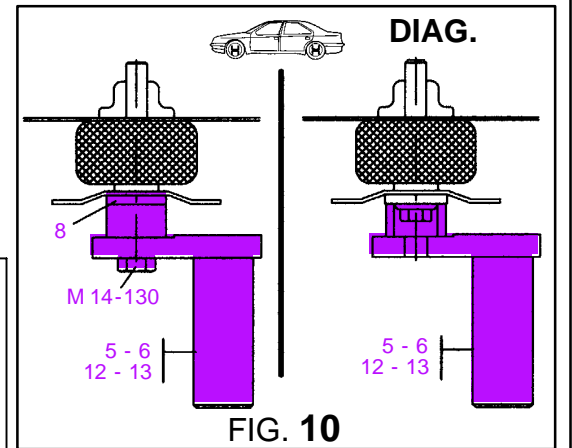
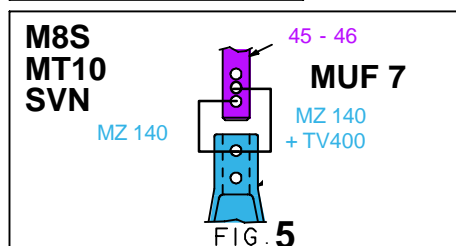
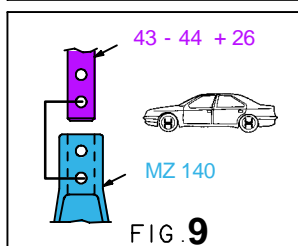
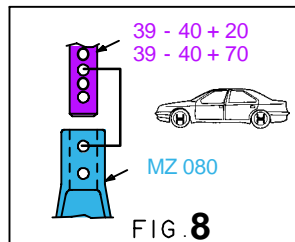
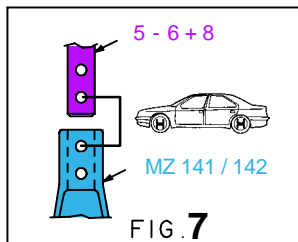
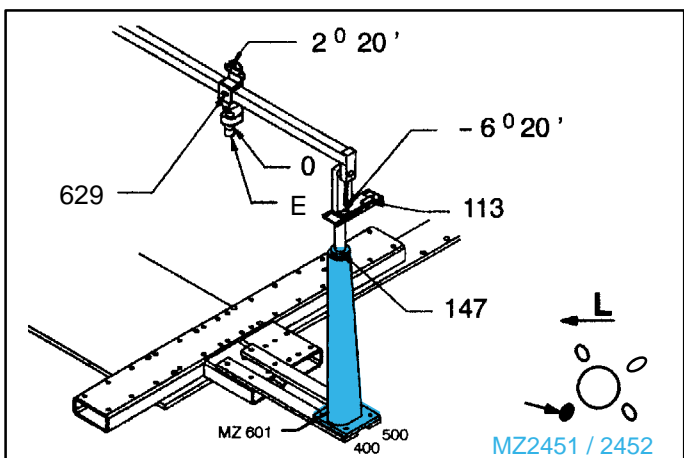
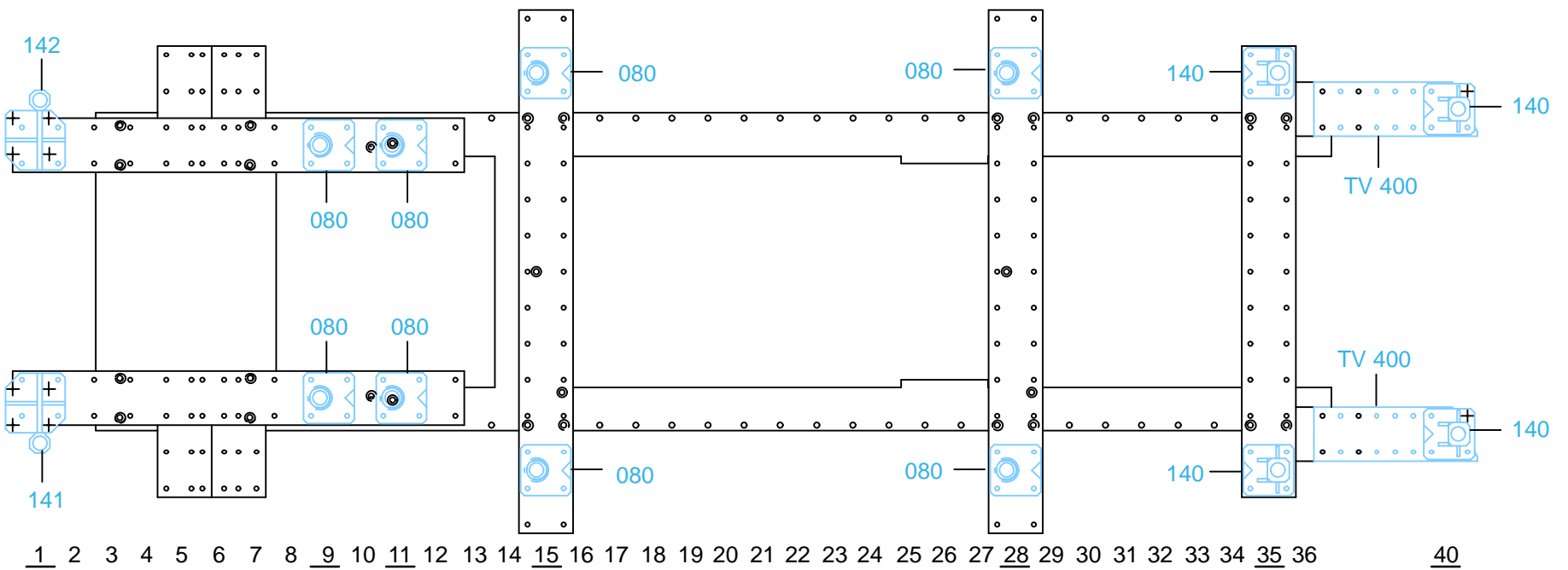

847.310-RVA3-1 | 00

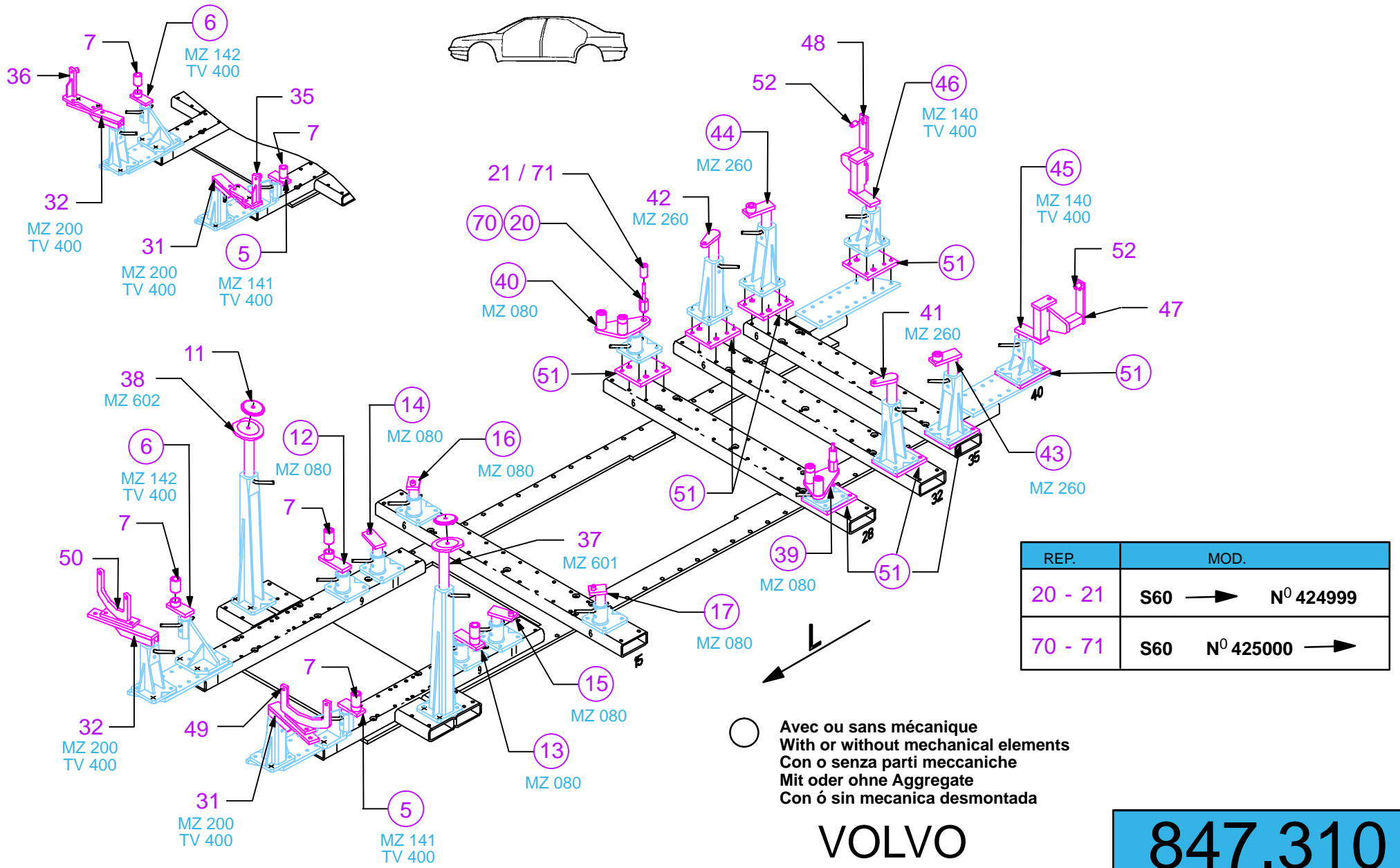

REP.	MOD.
20 - 21	S60 → N° 424999
70 - 71	S60 N° 425000 →

○ Avec ou sans mécanique
With or without mechanical elements
Con o senza parti meccaniche
Mit oder ohne Aggregate
Con ó sin mecanica desmontada

VOLVO

847.310

102 Kg 25.01.2005 439-D-11G

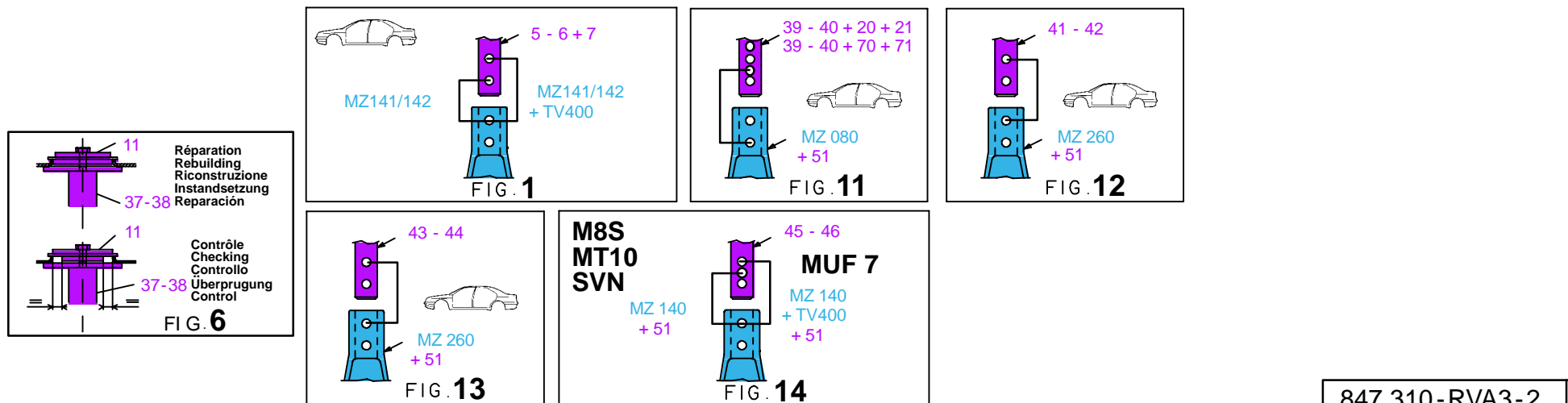
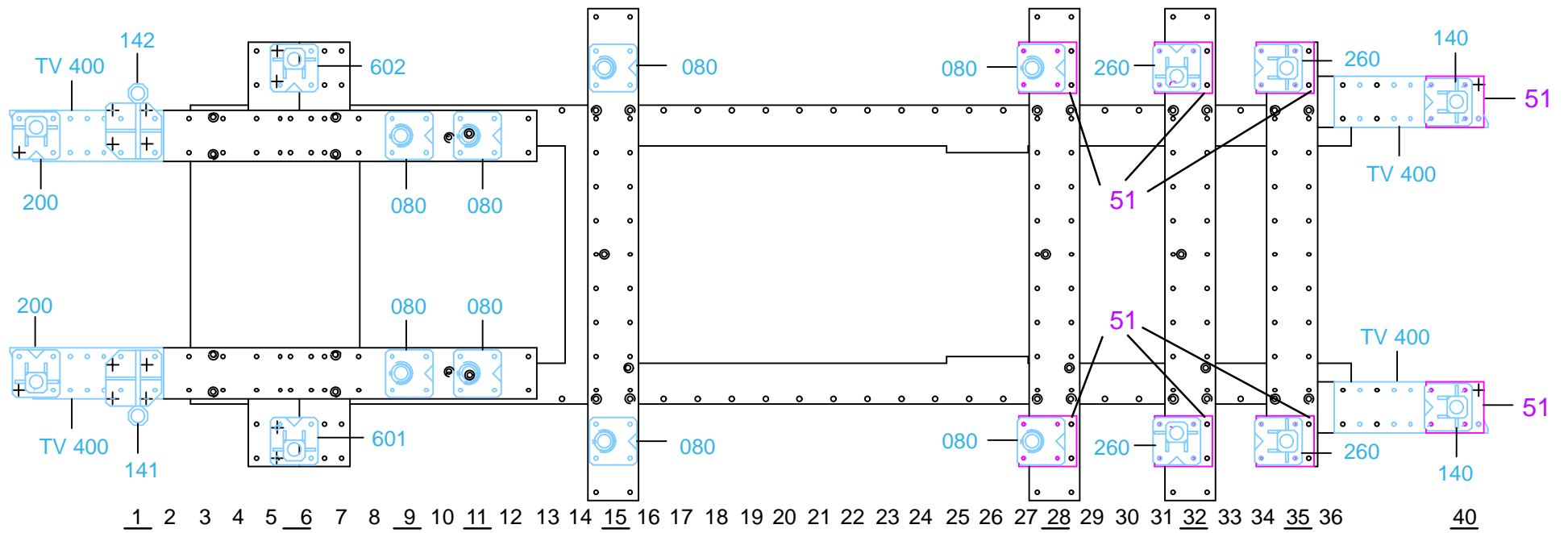

847.310-RVA3-2 00

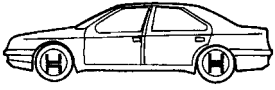

REP.	MOD.
20	S60 → N° 424999
70	S60 N° 425000 →

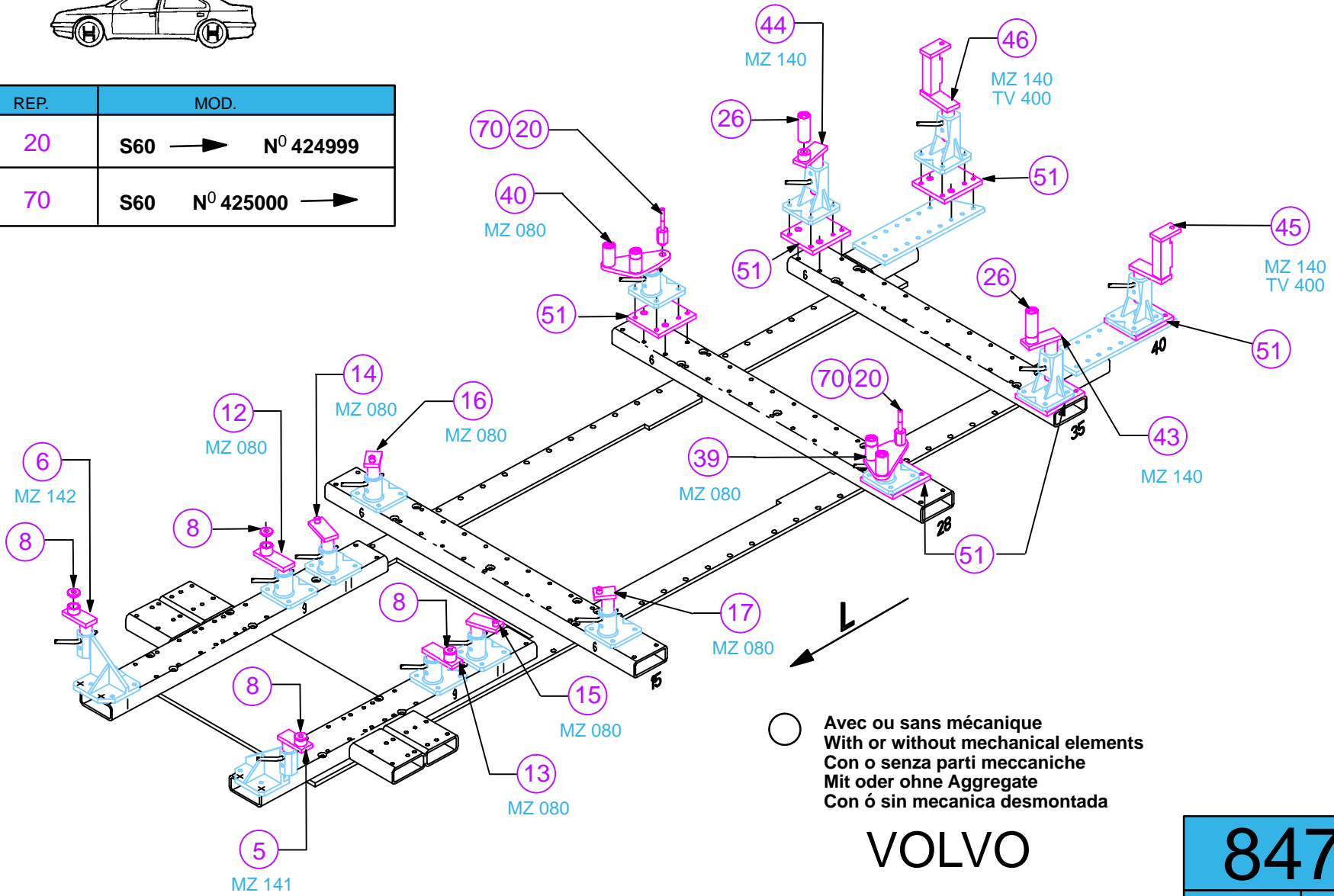

VOLVO

847.310

102 Kg | 25.01.2005 | 439-D-11H

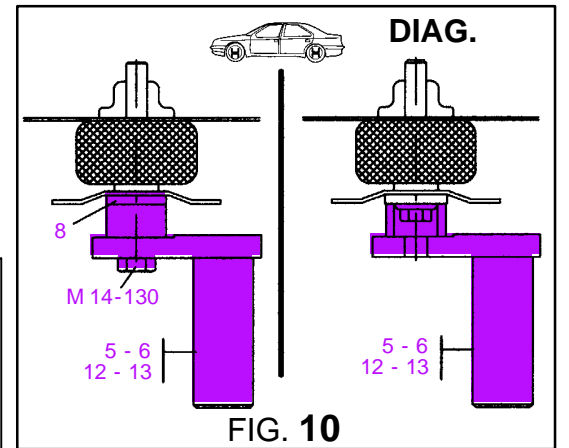
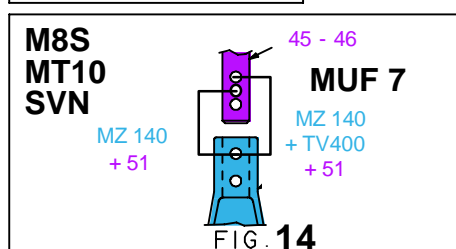
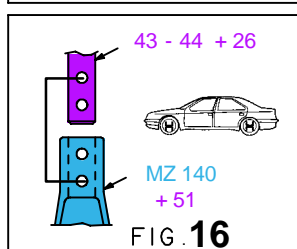
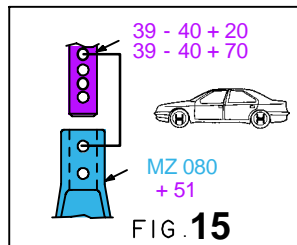
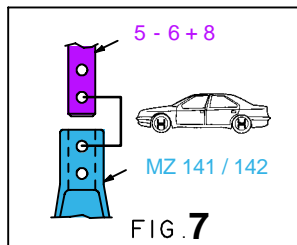
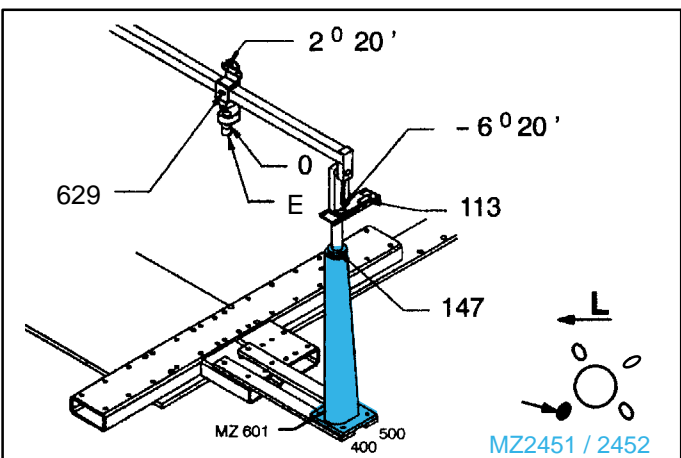
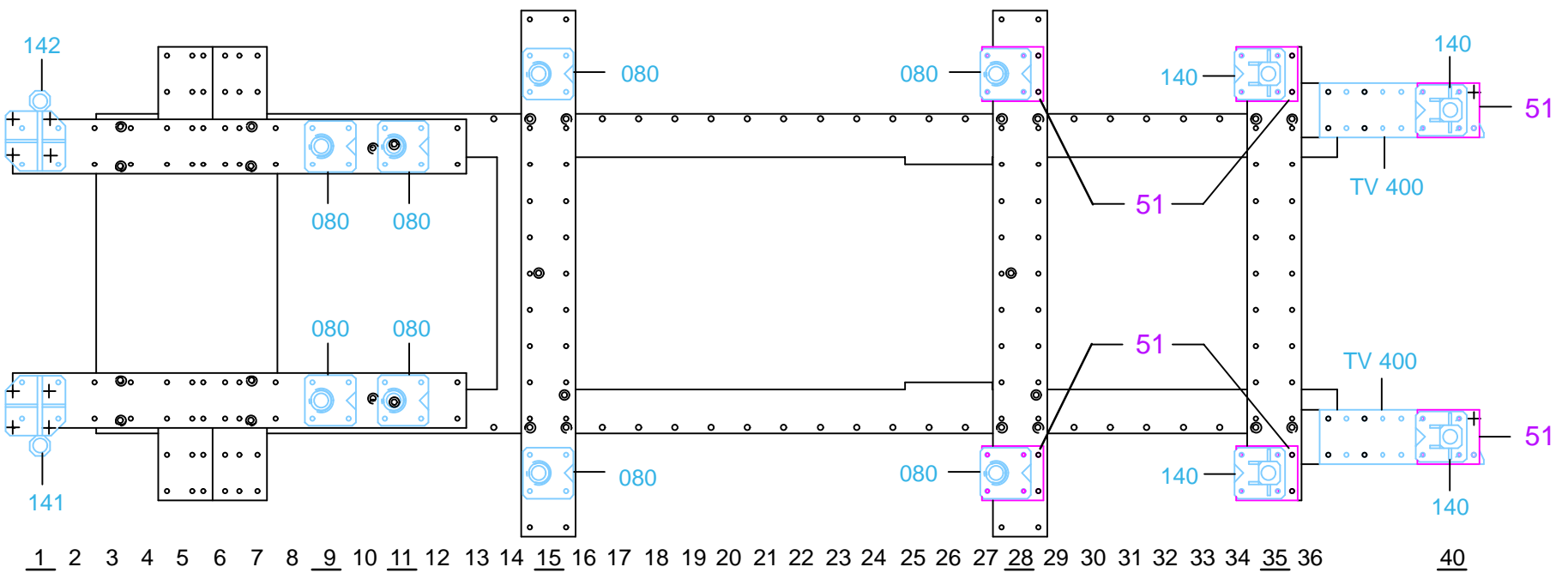

847.310-RVA3-2 | 00