

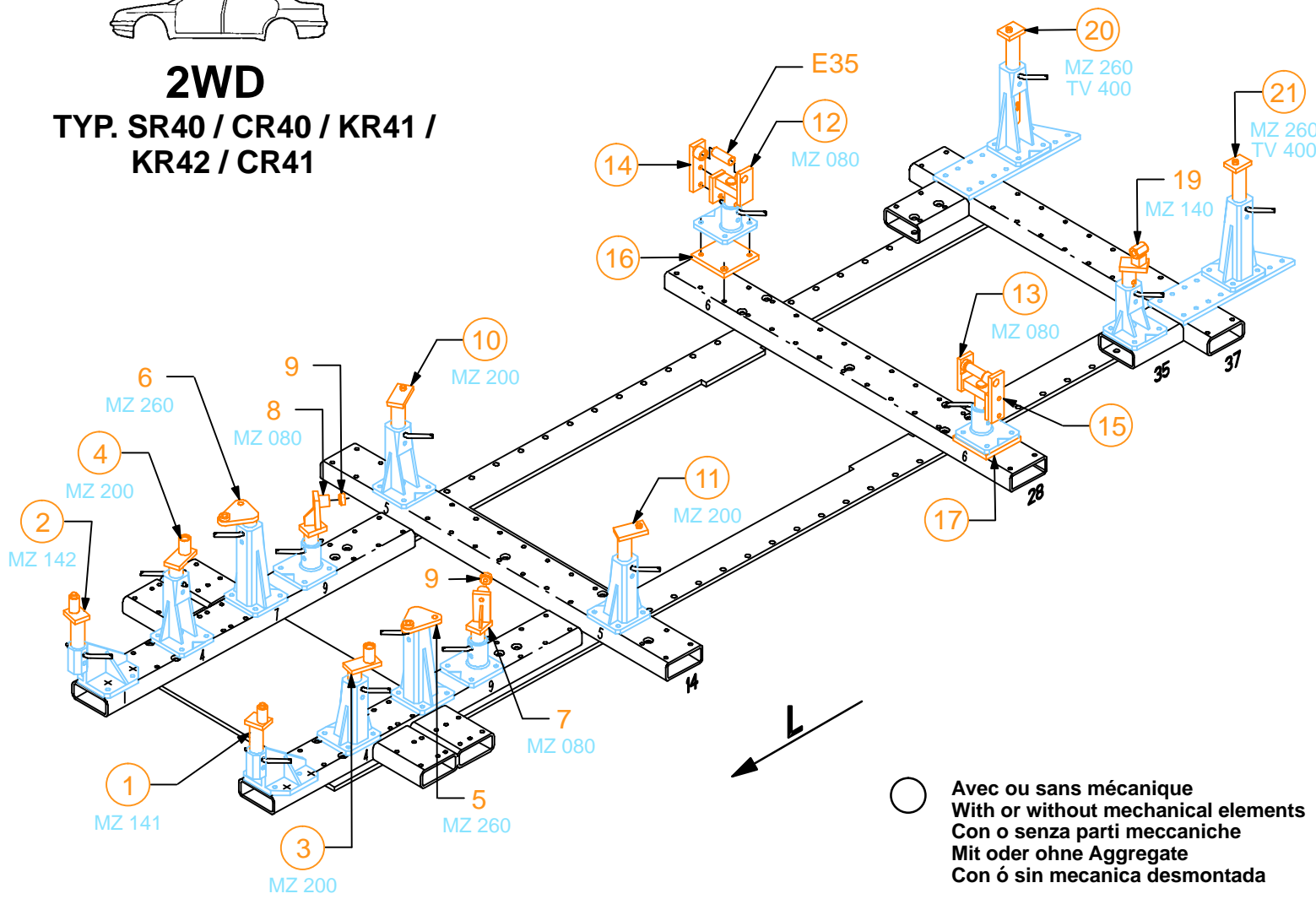

2WD
TYP. SR40 / CR40 / KR41 /
KR42 / CR41



○ Avec ou sans mécanique
With or without mechanical elements
Con o senza parti meccaniche
Mit oder ohne Aggregate
Con ó sin mecanica desmontada

TOYOTA

REP.	REFERENCE	PDS	NB	MZ
1	827.7001	2,2	1	141
2	827.7002	2,2	1	142
3	827.7003	1,9	1	200/140
4	827.7004	1,9	1	200/140
5	827.7005	1,8	1	260
6	827.7006	1,8	1	260
7	827.7007	2,2	1	080
8	827.7008	2,2	1	080
9	827.7009	0,1	2	
10	827.7010	2,0	1	200
11	827.7011	2,0	1	200
12	827.7012	2,5	1	080
13	827.7013	2,5	1	080
14	827.7014	1,0	1	
15	827.7015	1,0	1	
16	827.7016	2,4	1	
17	827.7017	2,4	1	
18	827.7018	2,4	1	
19	827.7019	2,0	1	140
20	827.7020	1,7	1	260
21	827.7021	1,7	1	260
22	827.7022	2,8	1	200
23	827.7023	2,8	1	200
24	827.7024	1,3	1	260
25	827.7025	1,3	1	260
26	827.7026	2,2	1	140
27	827.7027	2,2	1	140
	E.35	0,1	2	

CHc TB 12-25	6
M 8-30	4
M 12-25	6
M 12-30	4
M 12-35	2
M 14x1,50-40	4
M 14x1,50-50	2
M 14x1,50-60	2
M 14x1,50-100	2

827.300

54 Kg 06.09.2000 434-D-66A

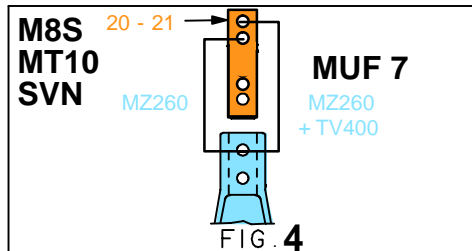
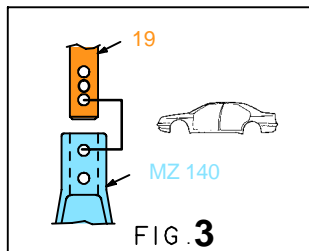
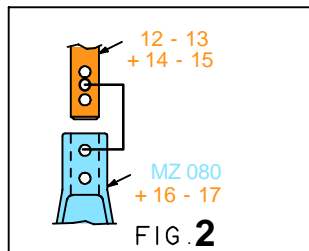
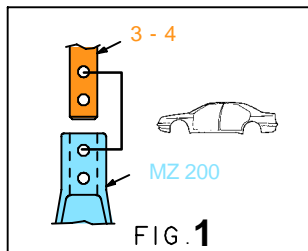
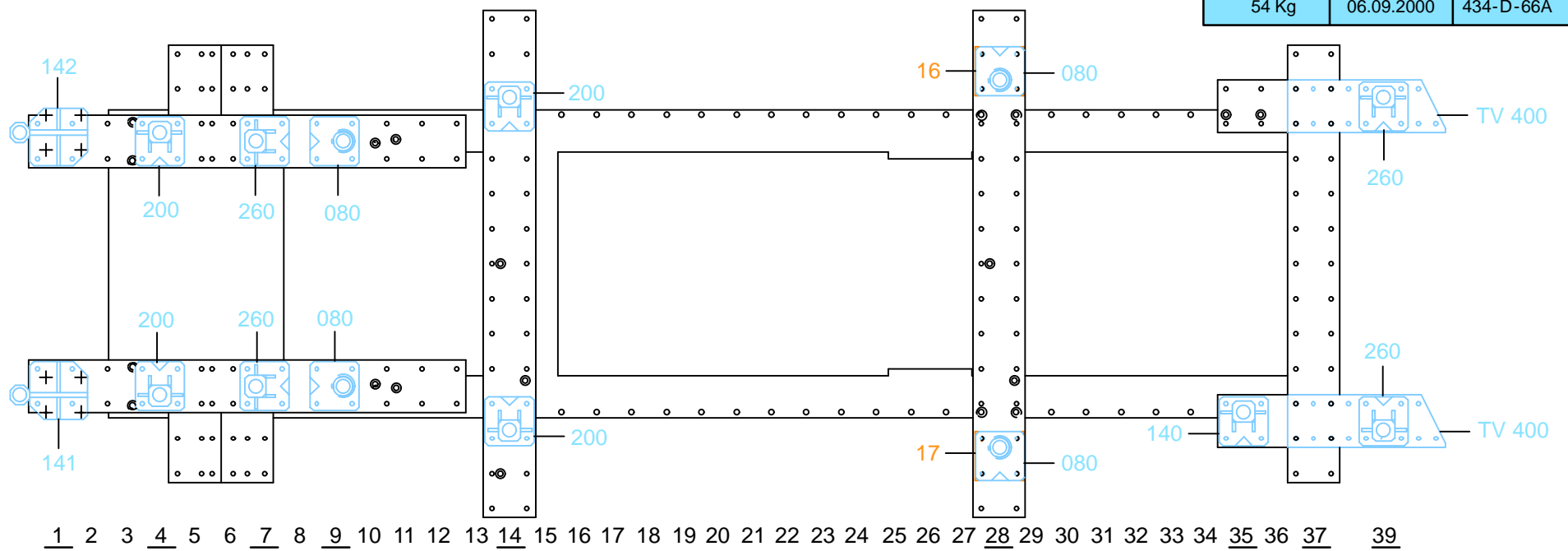

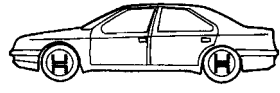

2WD

TYP. SR40 / CR40 / KR41 /
KR42 / CR41

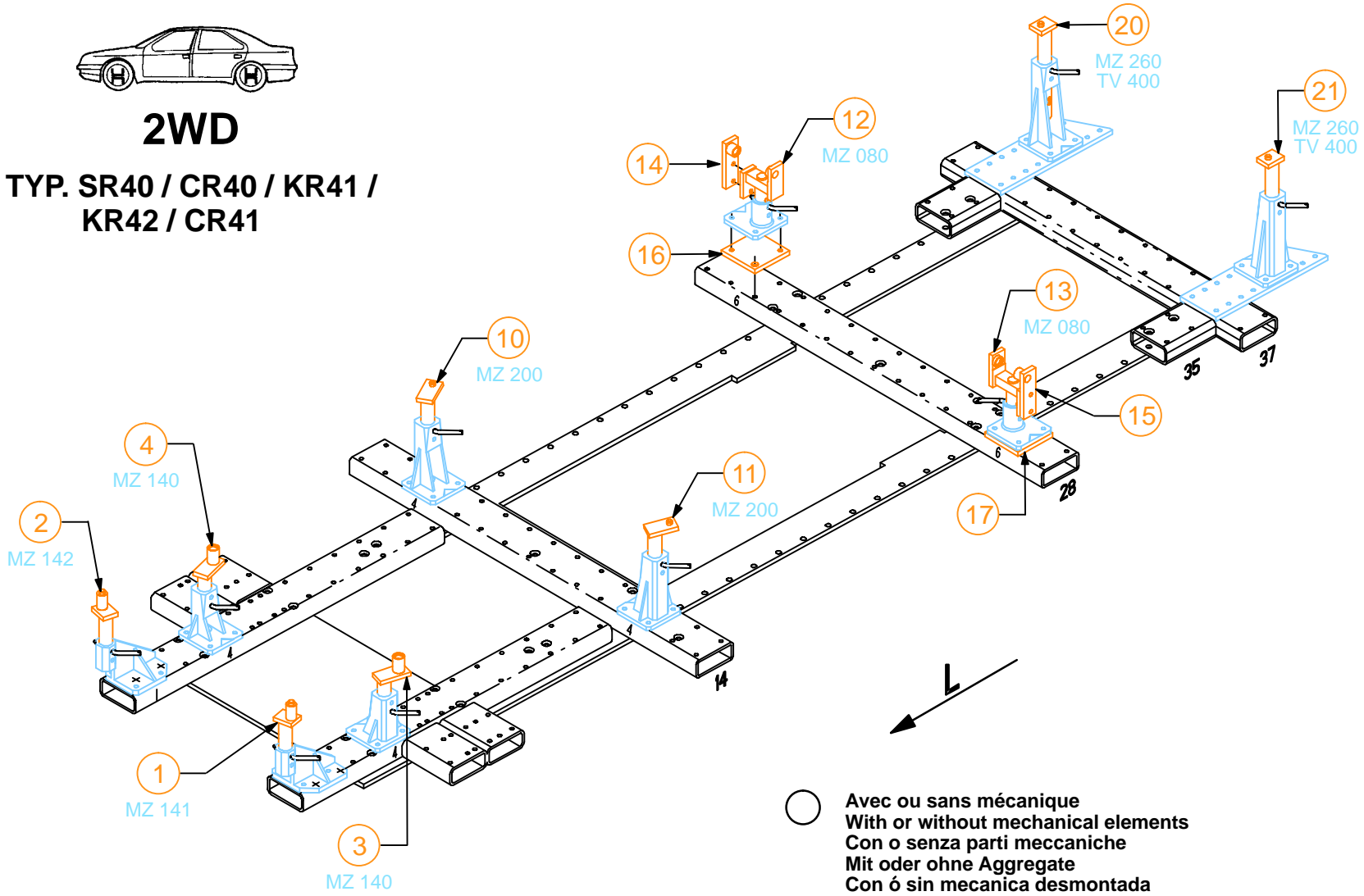

○ Avec ou sans mécanique
With or without mechanical elements
Con o senza parti meccaniche
Mit oder ohne Aggregate
Con ó sin mecanica desmontada

TOYOTA

827.300

54 Kg | 20.03.2000 | 434-D-66B

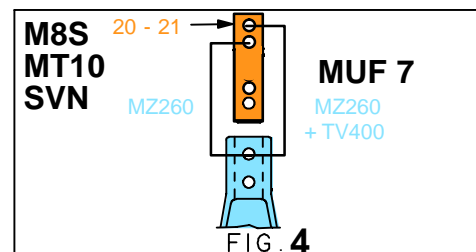
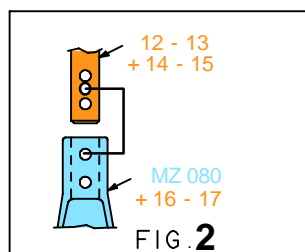
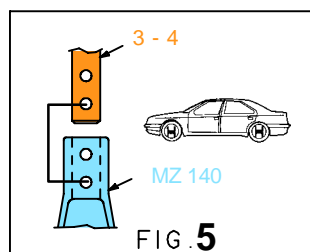
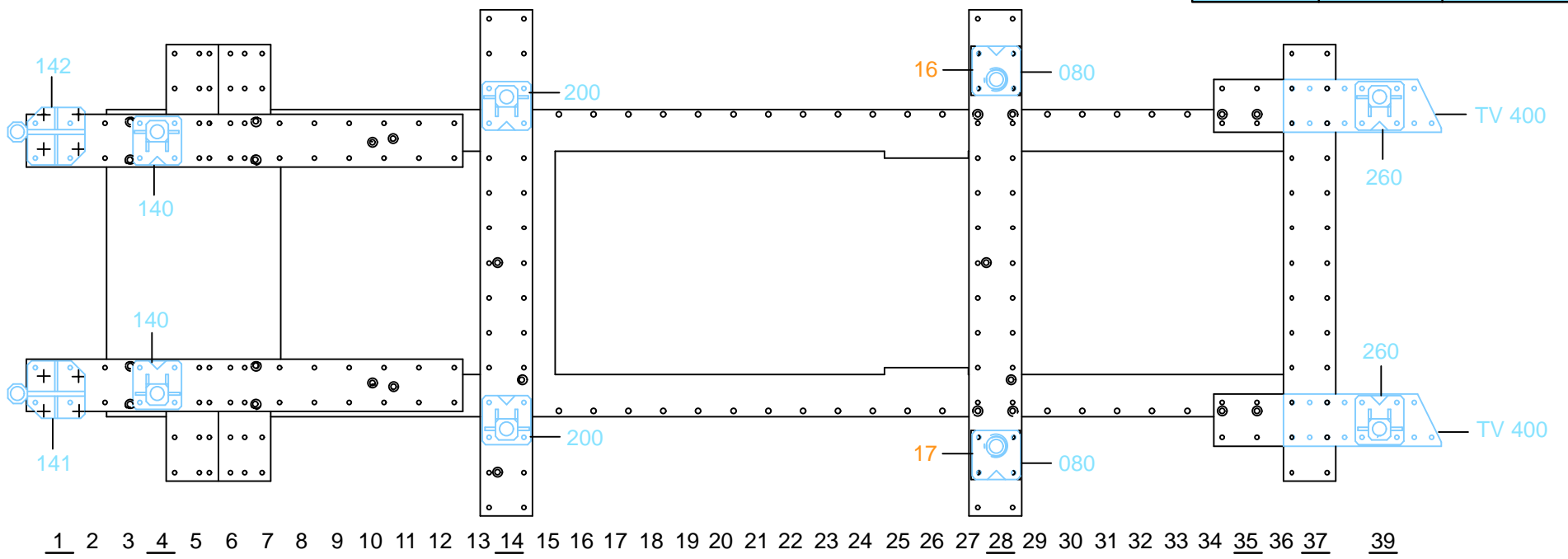



4WD

TYP. SR50 / CR50 / CR51

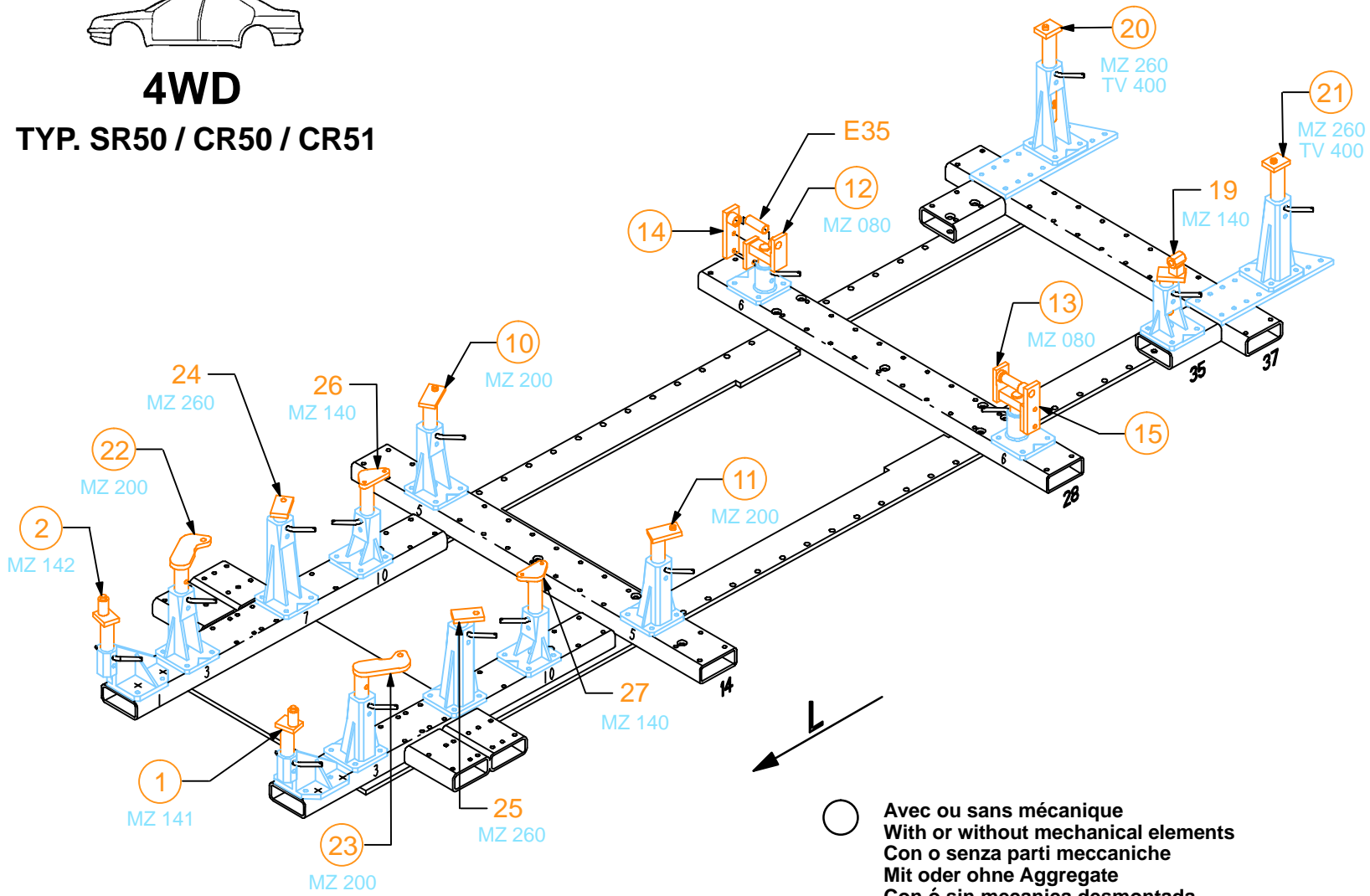

TOYOTA

827.300

54 Kg 20.03.2000 434-D-66C

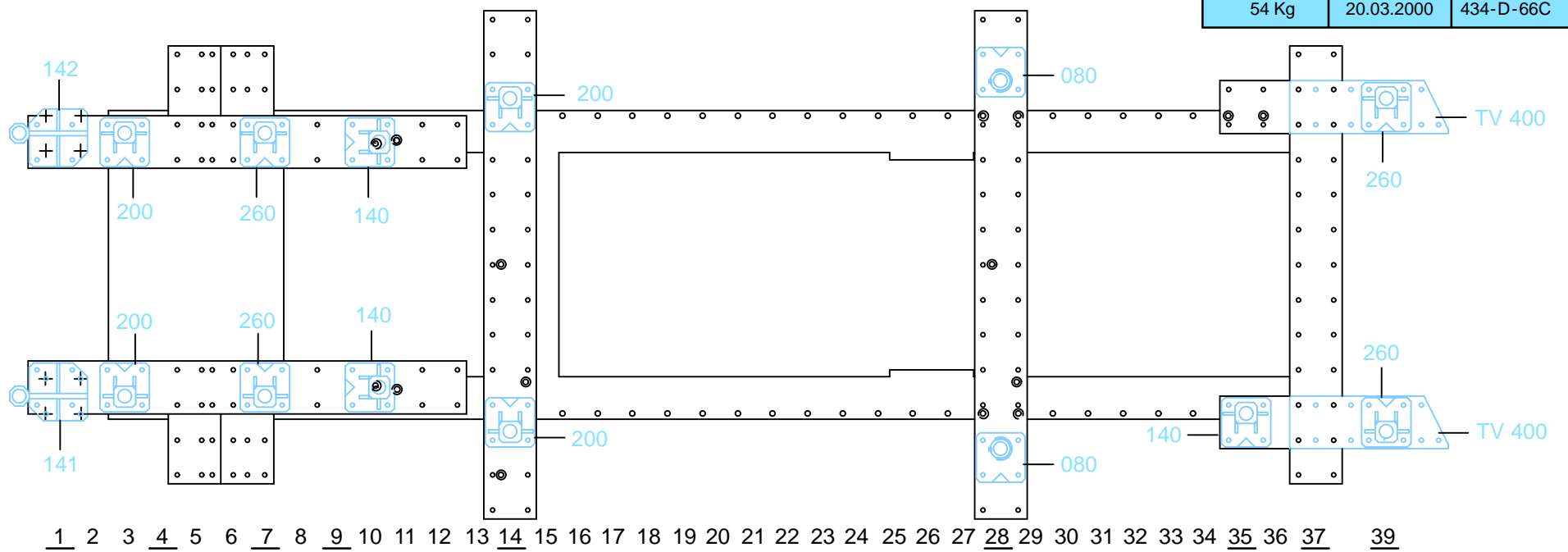

1 2 3 4 5 6 7 8 9 10 11 12 13 14 15 16 17 18 19 20 21 22 23 24 25 26 27 28 29 30 31 32 33 34 35 36 37 39

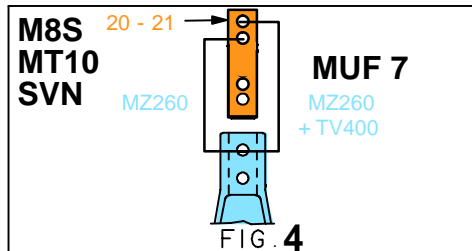
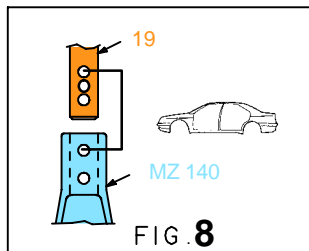
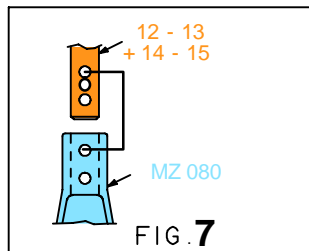
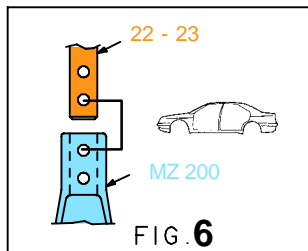



4WD

TYP. SR50 / CR50 / CR51

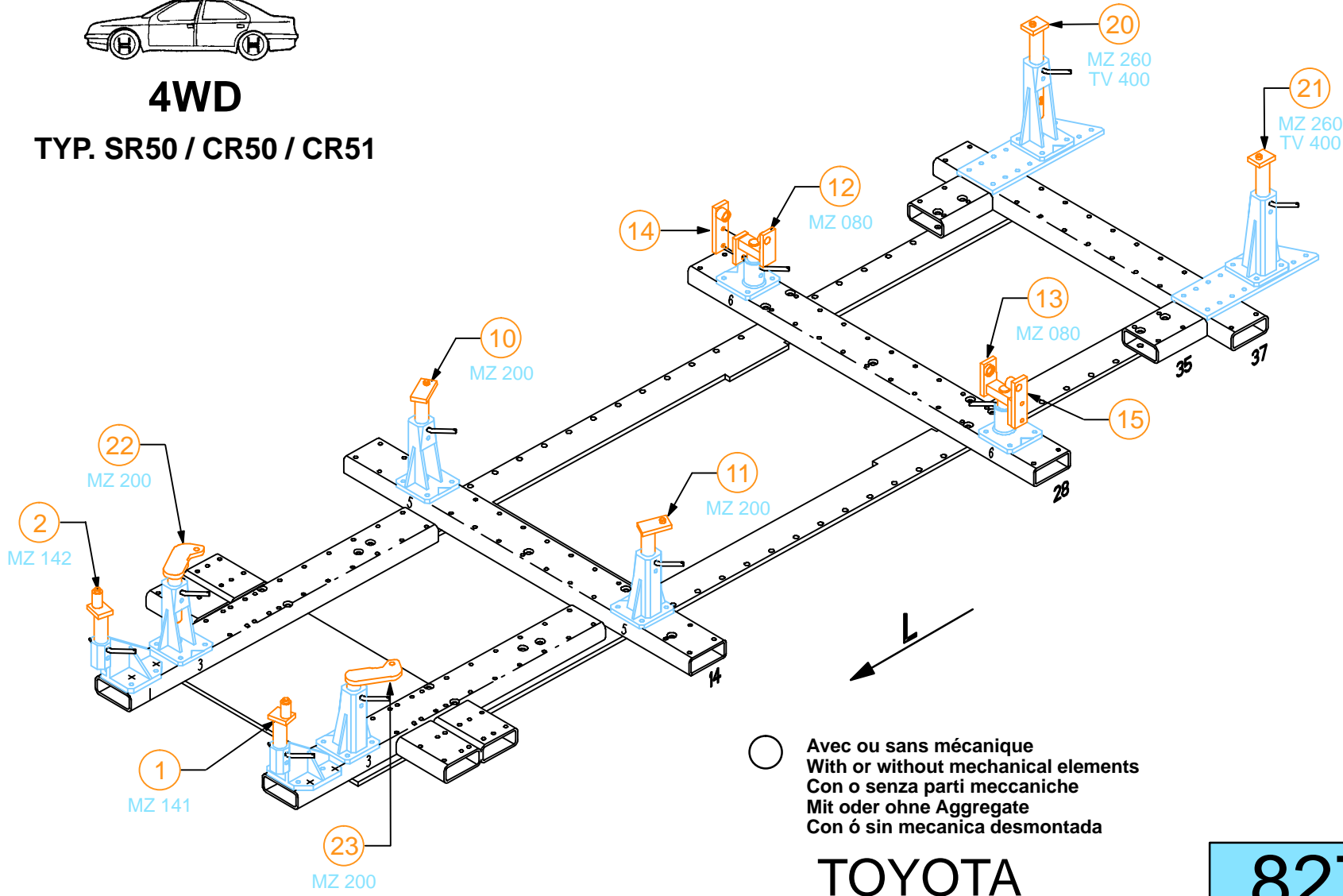

TOYOTA

827.300

54 Kg | 20.03.2000 | 434-D-66D

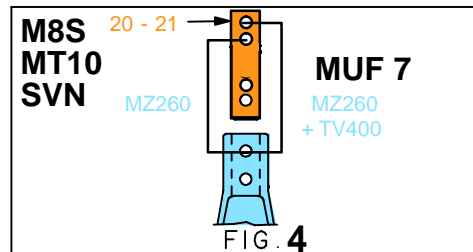
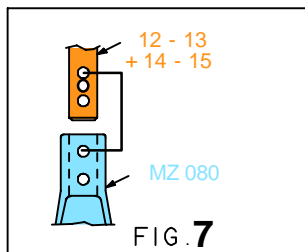
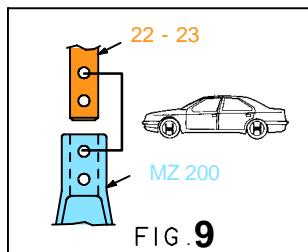
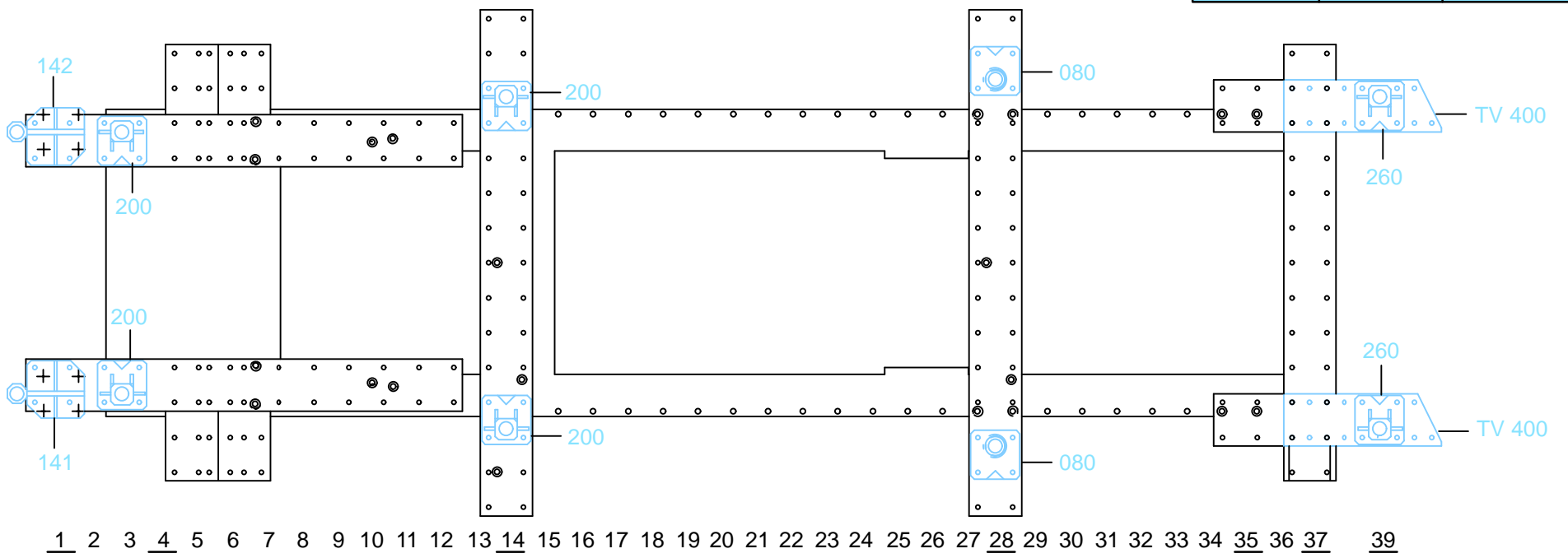

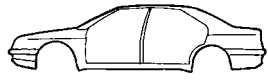

J/L

TYP. KR41 / KR42 / CR41

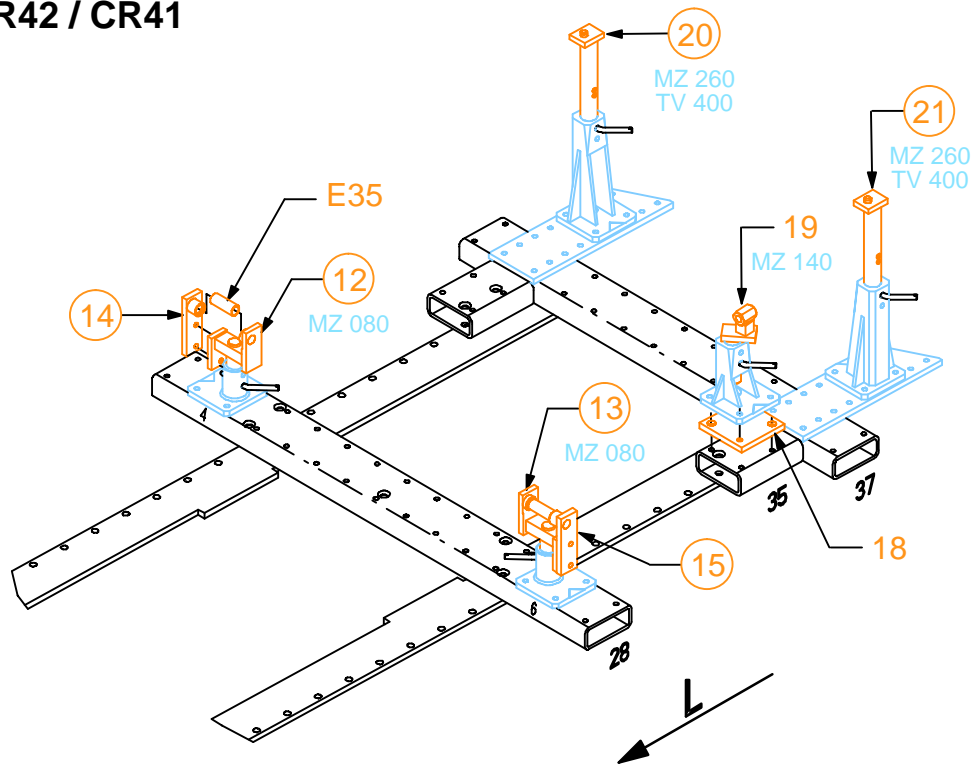

○ Avec ou sans mécanique
 With or without mechanical elements
 Con o senza parti meccaniche
 Mit oder ohne Aggregate
 Con ó sin mecanica desmontada

TOYOTA

827.300

54 Kg 20.03.2000 434-D-66E

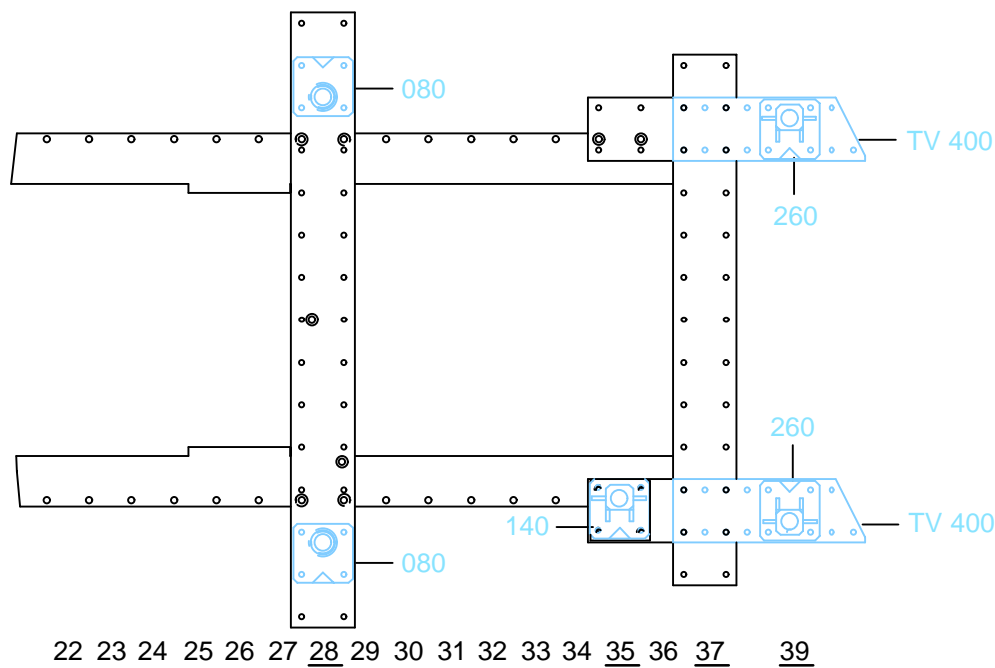

22 23 24 25 26 27 28 29 30 31 32 33 34 35 36 37 39

