

○ Avec ou sans mécanique  
 With or without mechanical elements  
 Con o senza parti meccaniche  
 Mit oder ohne Aggregate  
 Con ó sin mecanica desmontada

**SUZUKI**

| REP. | REFERENCE     | PDS | NB | MZ      |
|------|---------------|-----|----|---------|
| 1    | 825.7001      | 2,1 | 1  | 140/260 |
| 2    | 825.7002      | 2,1 | 1  | 140/260 |
| 3    | 825.7003      | 1,1 | 2  |         |
| 4    | 825.7004      | 1,9 | 1  | 260     |
| 5    | 825.7005      | 1,9 | 1  | 260     |
| 6    | 825.7006      | 2,0 | 1  | 602     |
| 7    | 825.7007      | 2,0 | 1  | 601     |
| 8    | 825.7008      | 0,9 | 2  |         |
| 9    | 825.7009      | 1,6 | 1  | 080     |
| 10   | 825.7010      | 1,6 | 1  | 080     |
| 11   | 825.7011      | 2,3 | 1  | 140     |
| 12   | 825.7012      | 2,3 | 1  | 140     |
| 13   | 825.7013      | 1,8 | 1  | 080     |
| 14   | 825.7014      | 1,8 | 1  | 080     |
| 15   | 825.7015      | 1,8 | 1  | 080     |
| 16   | 825.7016      | 1,8 | 1  | 080     |
| 17   | 825.7017      | 1,9 | 1  | 080     |
| 18   | 825.7018      | 1,9 | 1  | 080     |
| 19   | 825.7019      | 2,2 | 1  | 200     |
| 20   | 825.7020      | 2,2 | 1  | 200     |
| 21   | 825.7021      | 2,2 | 1  | 142     |
| 22   | 825.7022      | 2,2 | 1  | 260     |
| 23   | 825.7023      | 2,2 | 1  | 260     |
| 24   | 825.7024 V.54 | 3,1 | 6  |         |
|      |               | 0,1 | 2  |         |

|  |              |    |
|--|--------------|----|
|  | M 12-25      | 4  |
|  | M 12x1,25-50 | 2  |
|  | M 12x1,25-70 | 2  |
|  | TFHc 16-60   | 12 |
|  | 955714       | 12 |
|  | M 12         | 2  |

**825.300**

66 Kg    20.06.2001    445-D-10A

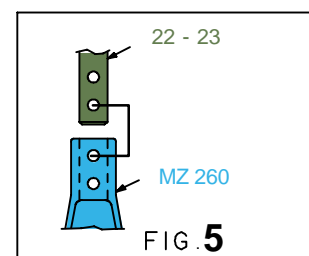
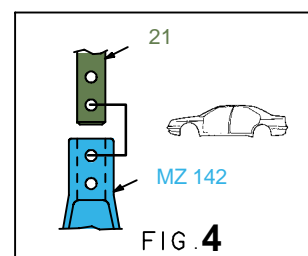
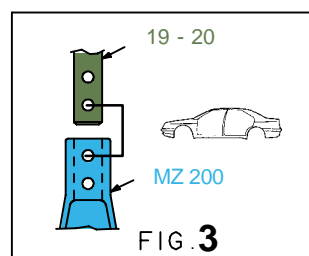
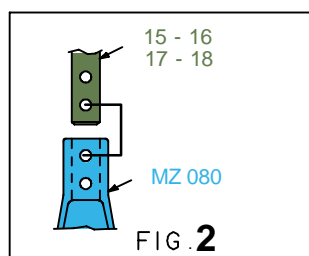
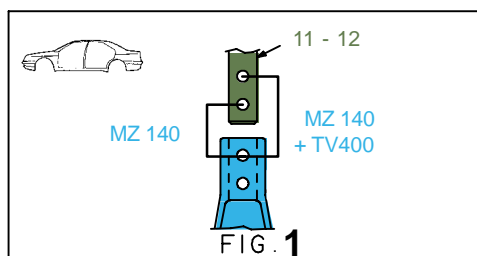
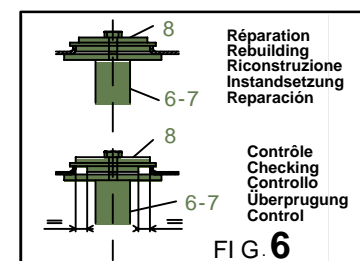
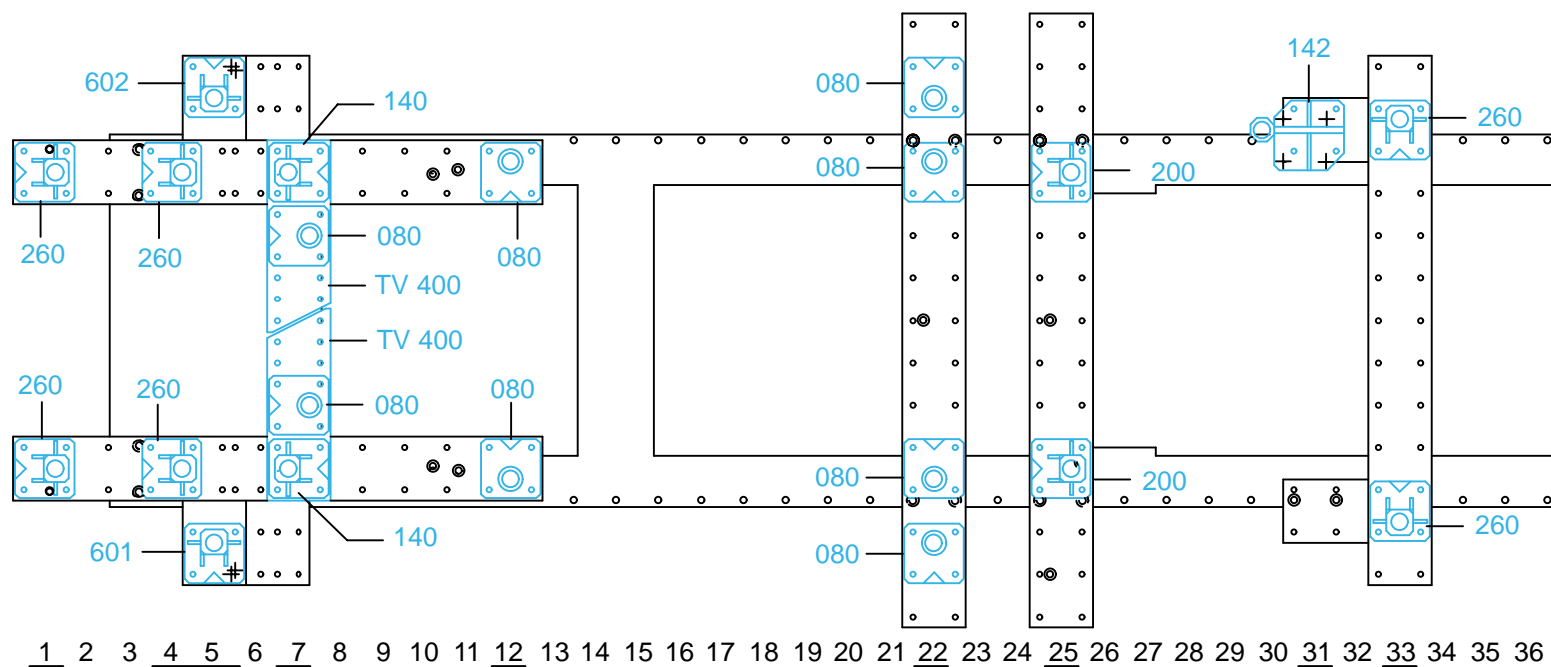

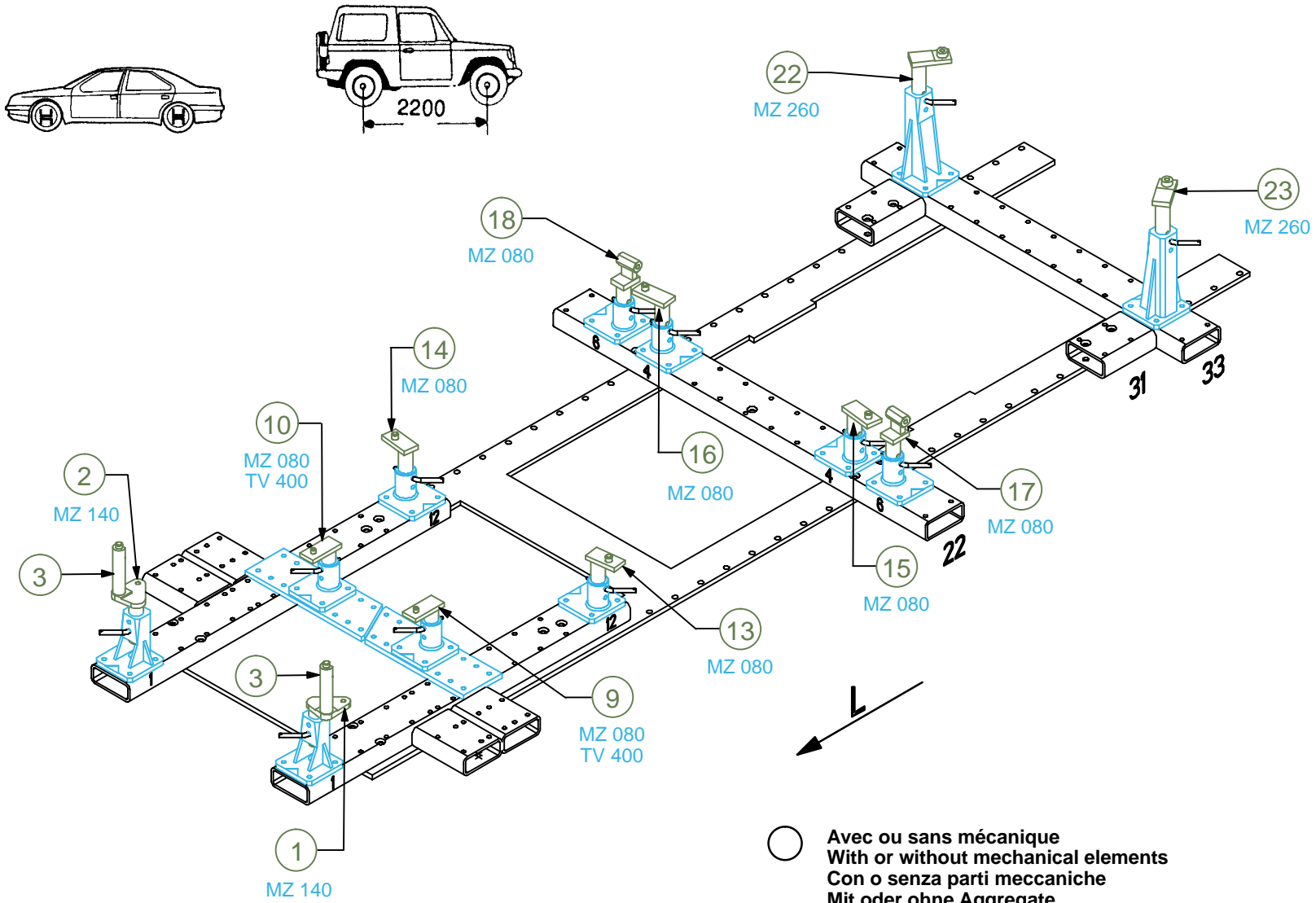

**SUZUKI**

**825.300**

66 Kg    20.06.2001    445-D-10B

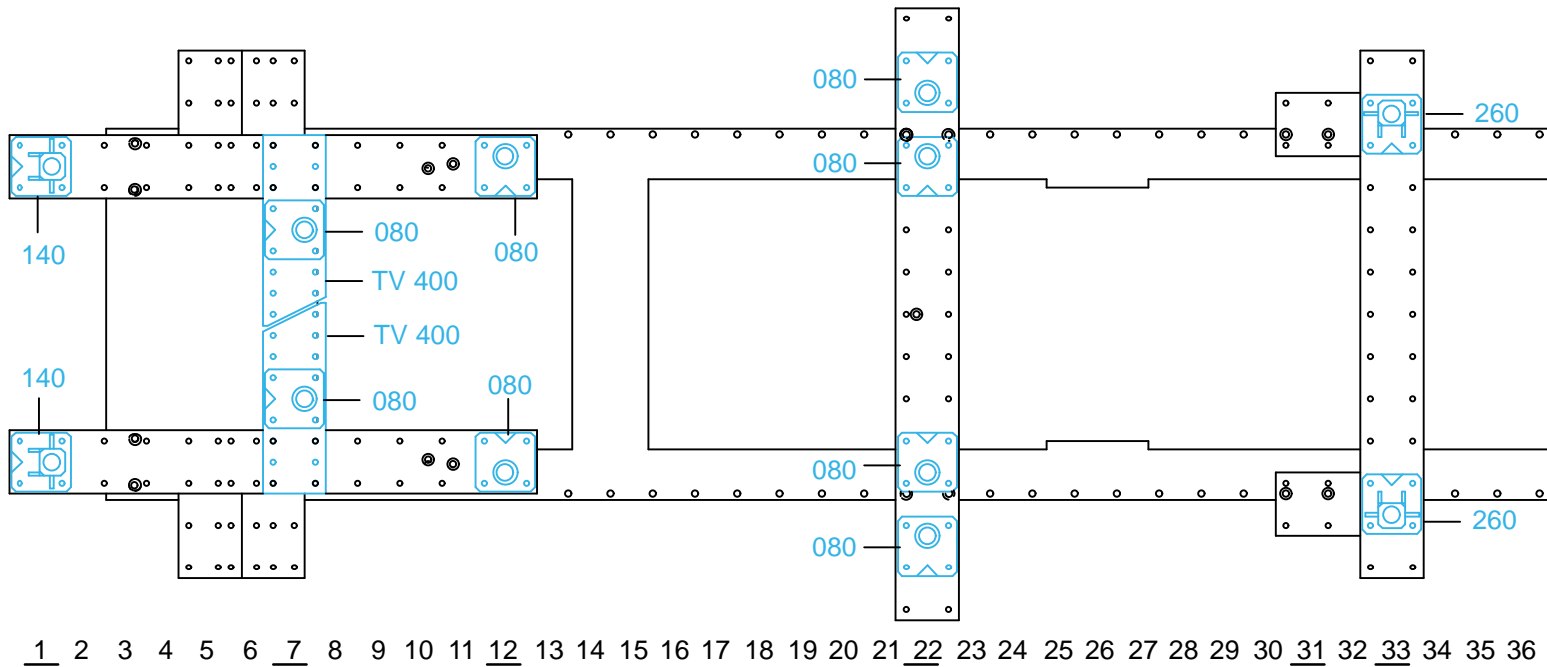

1 2 3 4 5 6 7 8 9 10 11 12 13 14 15 16 17 18 19 20 21 22 23 24 25 26 27 28 29 30 31 32 33 34 35 36

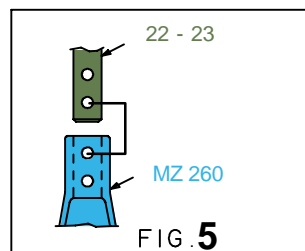
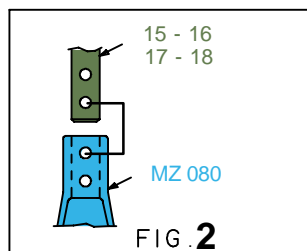

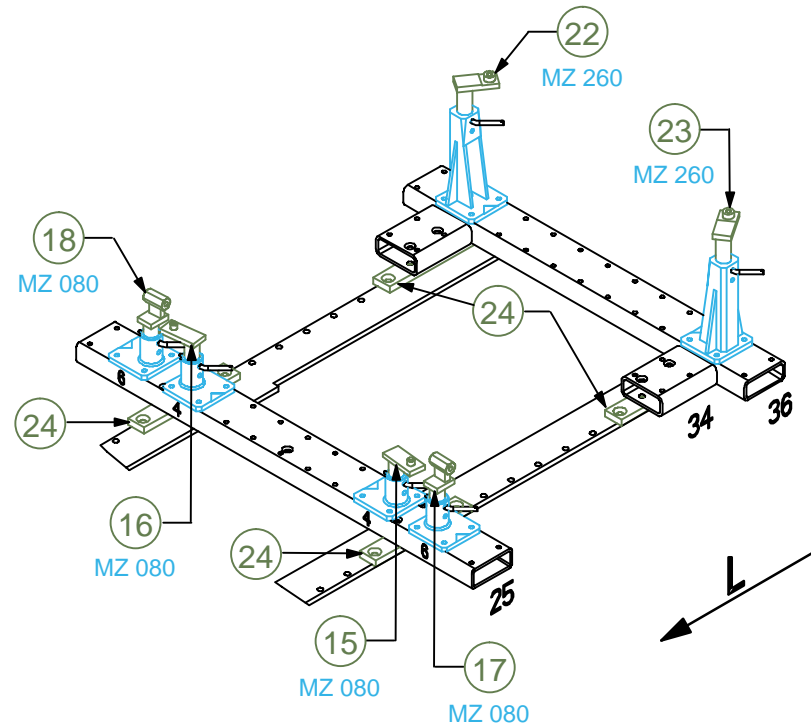
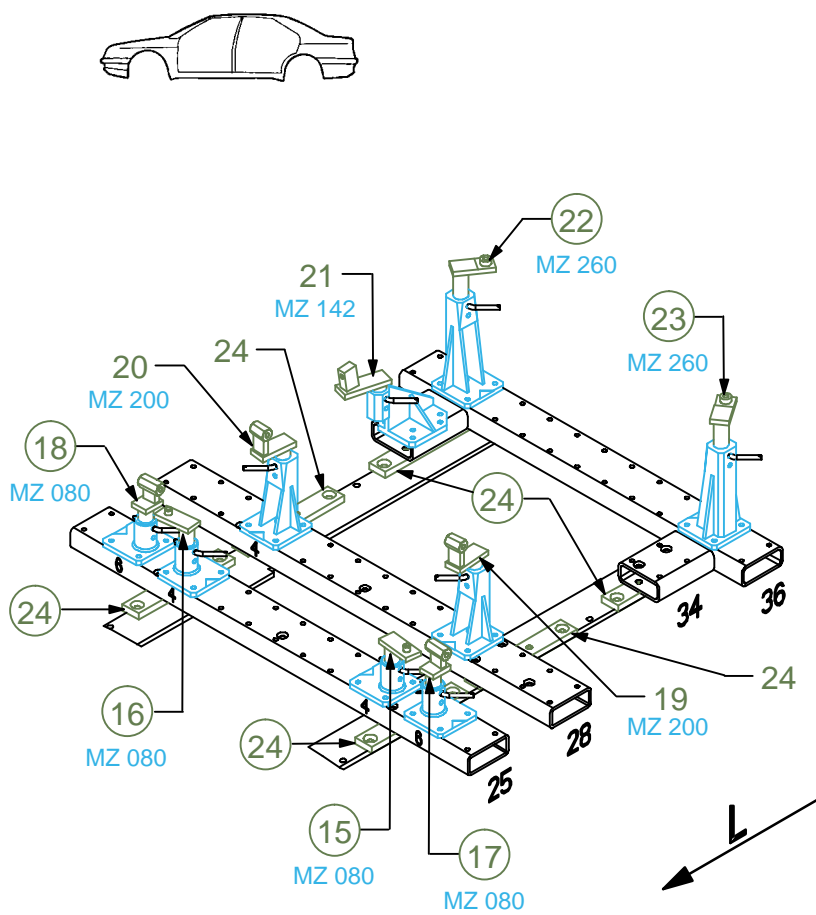
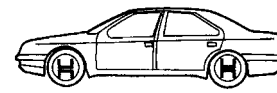
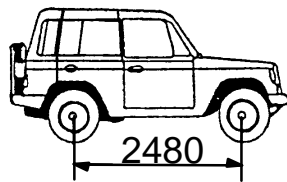

○ Avec ou sans mécanique  
 With or without mechanical elements  
 Con o senza parti meccaniche  
 Mit oder ohne Aggregate  
 Con ó sin mecanica desmontada

**SUZUKI**

**825.300**

66 Kg    20.06.2001    445-D-10C

