

○ Avec ou sans mécanique
 With or without mechanical elements
 Con o senza parti meccaniche
 Mit oder ohne Aggregate
 Con ó sin mecanica desmontada

REP.	REFERENCE	PDS	NB	MZ
70	819.7070	4,0	1	142
71	819.7071	4,1	1	141
72	819.7072	2,7	1	
73	819.7073	2,7	1	
76	819.7076	3,5	1	602
77	819.7077	3,5	1	601
78	819.7078	1,1	2	

	M 10-40 M 12-70	2 2
	MU 12	2
	M 10	2

complément au
 complementary set to
 complemento al
 zusatz zu

819.310
 +
819.304

819.312

23 Kg 07.04.2008 431-D-7C

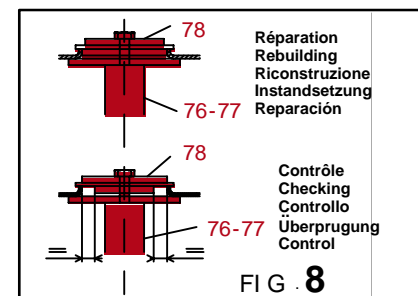
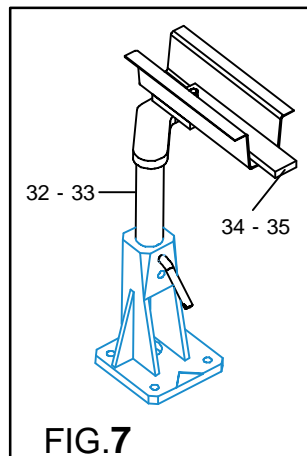
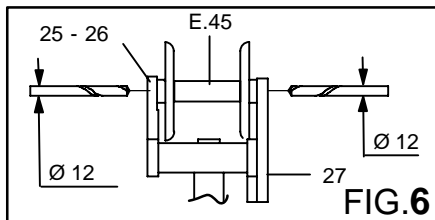
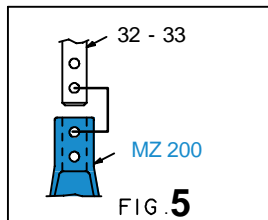
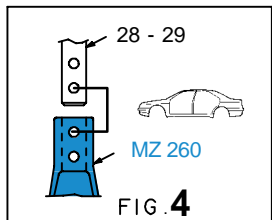
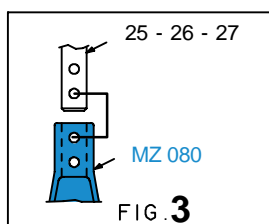
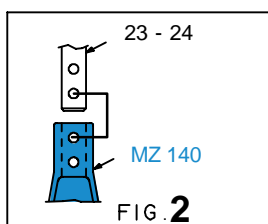
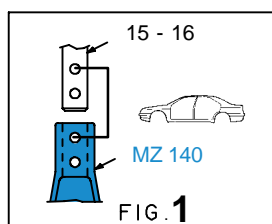
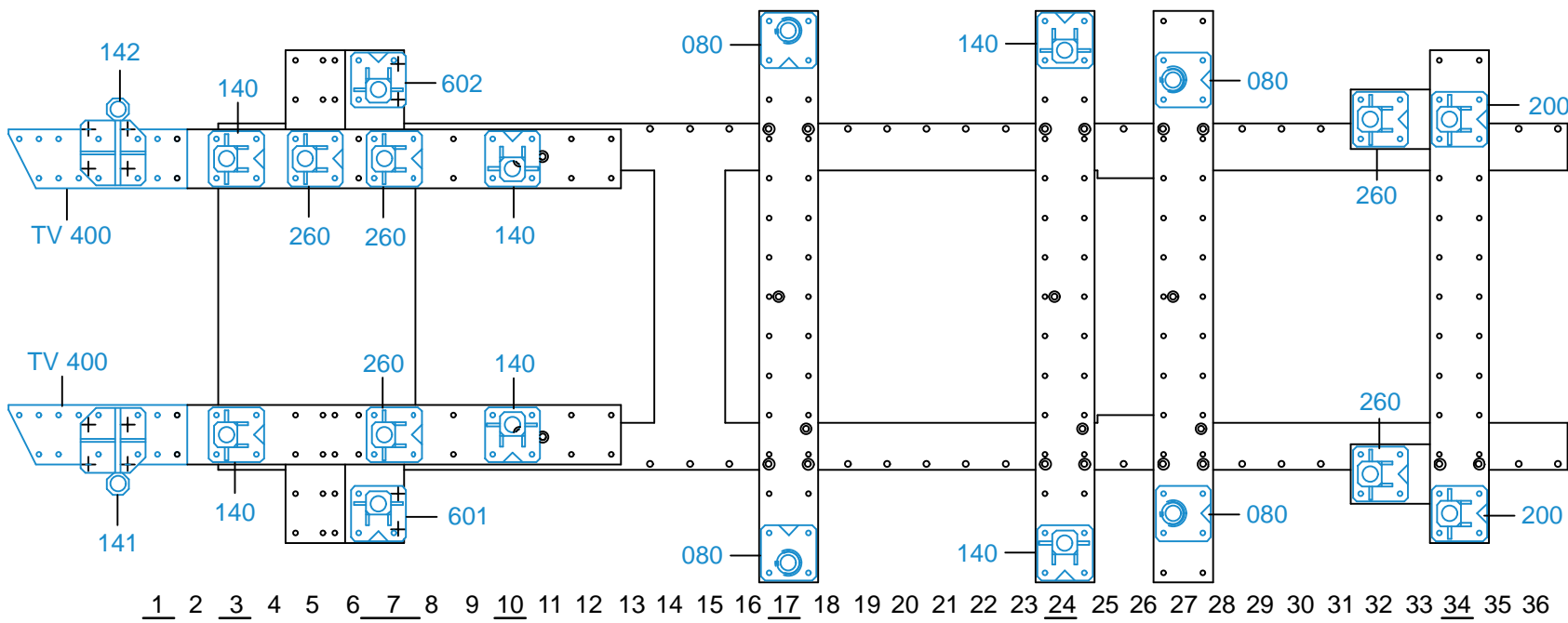

819.312-RVA3-1 00

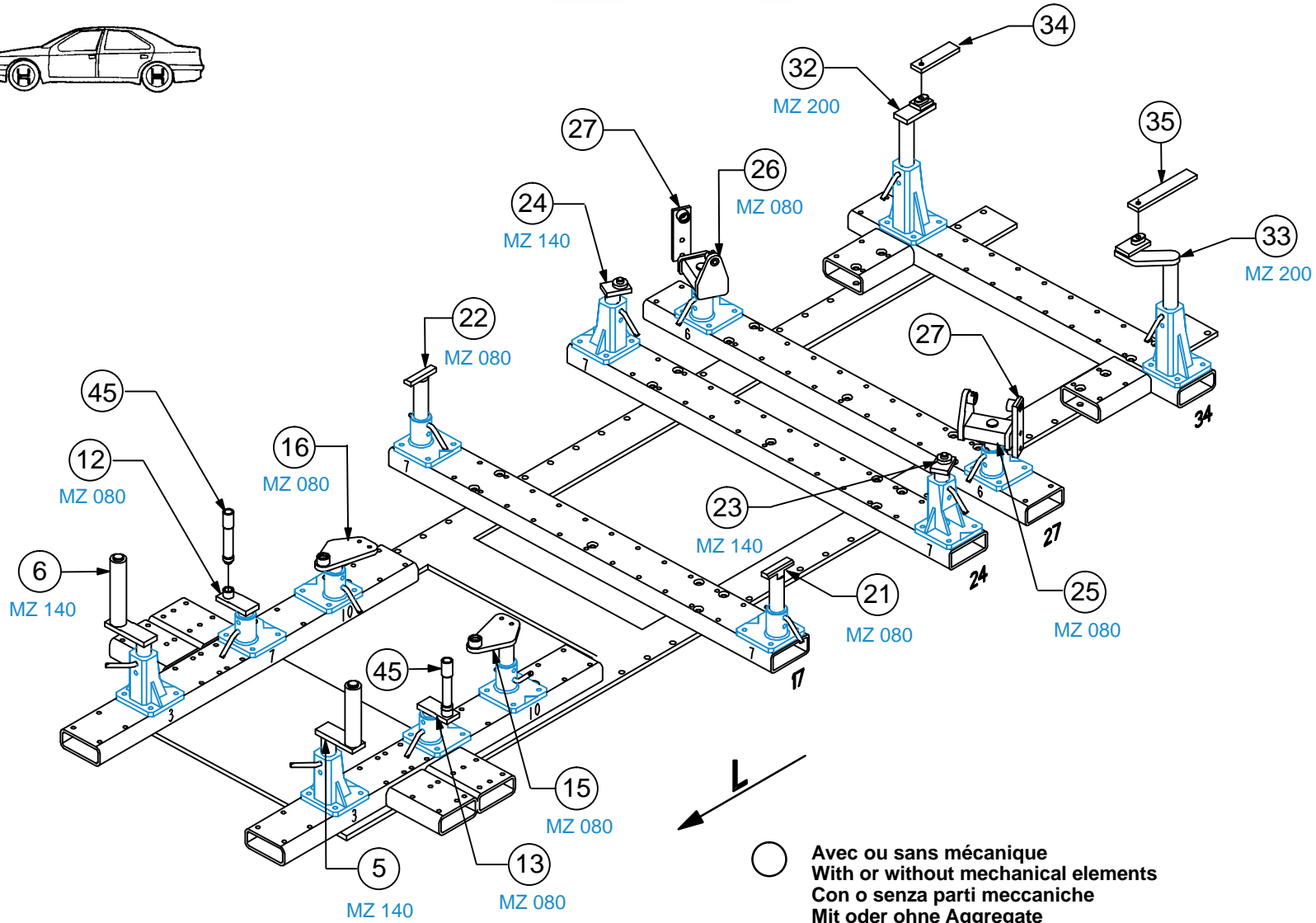

819.312

23 Kg | 07.04.2008 | 431-D-7D

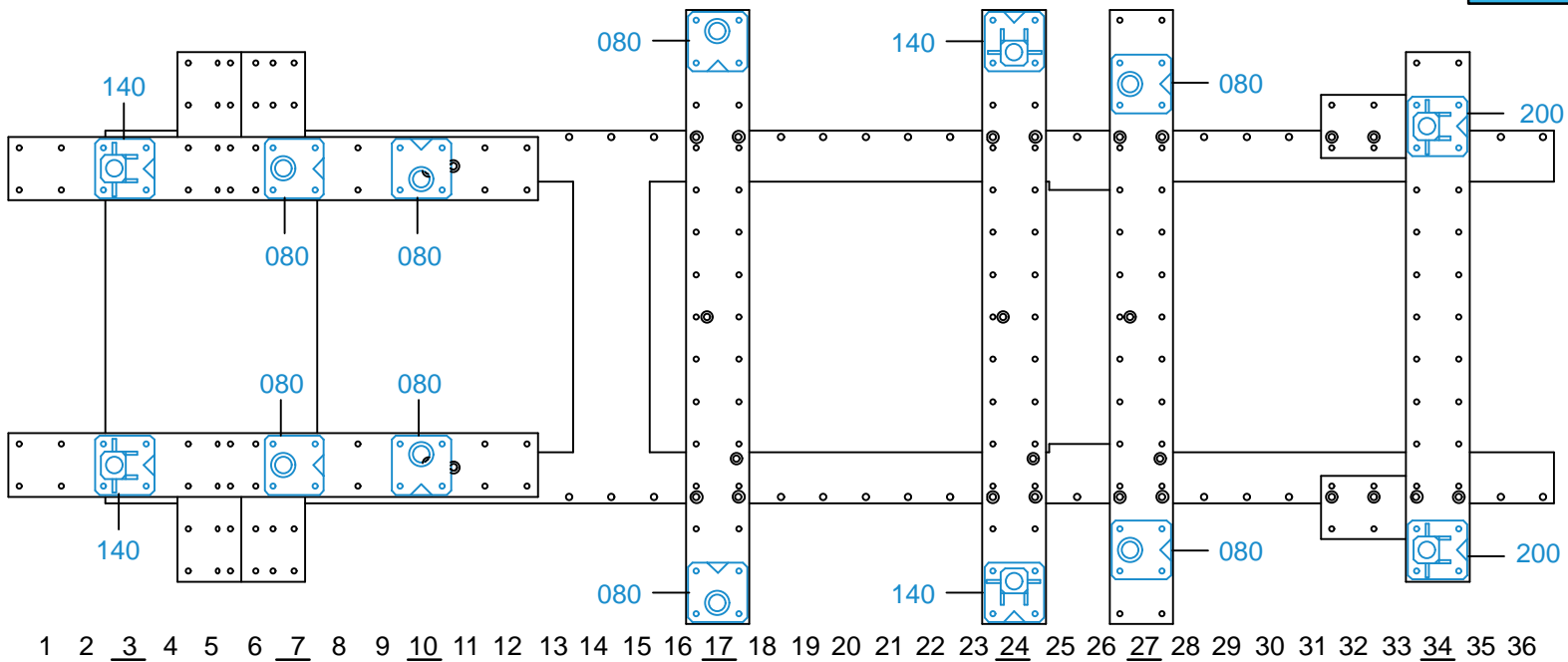

1 2 3 4 5 6 7 8 9 10 11 12 13 14 15 16 17 18 19 20 21 22 23 24 25 26 27 28 29 30 31 32 33 34 35 36

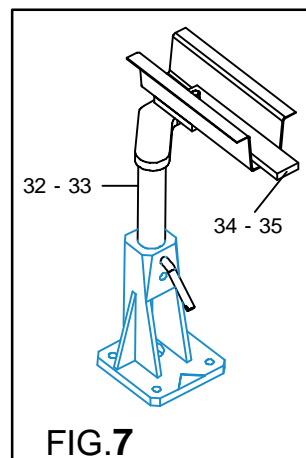
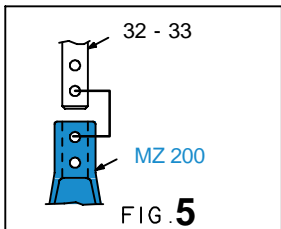
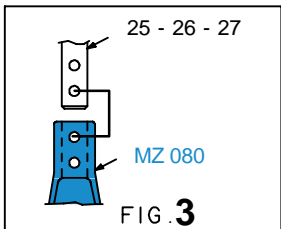
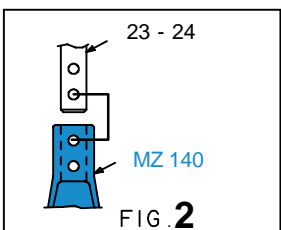
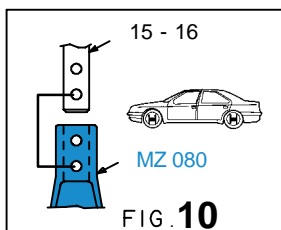
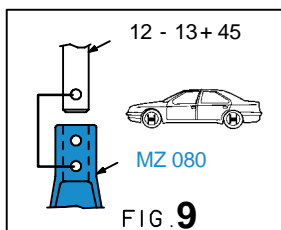

819.312-RVA3-1 | 00