

| REP. | REFERENCE | PDS | NB | MZ |
|------|-----------|------|----|---------|
| 26 | 805.7026 | 2,3 | 1 | 141 |
| 27 | 805.7027 | 2,3 | 1 | 142 |
| 28 | 805.7028 | 2,7 | 1 | 260 |
| 29 | 805.7029 | 2,7 | 1 | 260 |
| 30 | 805.7030 | 2,6 | 1 | 200/080 |
| 31 | 805.7031 | 2,6 | 1 | 200/080 |
| 32 | 805.7032 | 0,06 | 4 | |
| 33 | 805.7033 | 2,8 | 1 | 601 |
| 34 | 805.7034 | 2,8 | 1 | 602 |
| 35 | 805.7035 | 0,7 | 2 | |
| 36 | 805.7036 | 1,7 | 1 | 140/080 |
| 37 | 805.7037 | 1,7 | 1 | 140/080 |
| 38 | 805.7038 | 2,4 | 1 | 200/140 |
| 39 | 805.7039 | 2,4 | 1 | 200/140 |
| 40 | 805.7040 | 0,4 | 2 | |
| 41 | 805.7041 | 2,2 | 1 | 260 |
| 42 | 805.7042 | 2,2 | 1 | 260 |
| 43 | 805.7043 | 0,1 | 2 | |

| | |
|---------------|---|
| M 12-25 | 2 |
| M 12x1,25-30 | 2 |
| M 12x1,25-35 | 2 |
| M 12x1,25-50 | 2 |
| M 12x1,25-90 | 2 |
| M 16x1,50-50 | 2 |
| M 16x1,50-70 | 2 |
| M 16x1,50-150 | 2 |
| M 16x1,50-170 | 2 |

complément au complementary set to complemento al zusatz zu **805.300**

805.309
 37 Kg | 11.02.2004 | 434-D-60C

TOYOTA / LEXUS

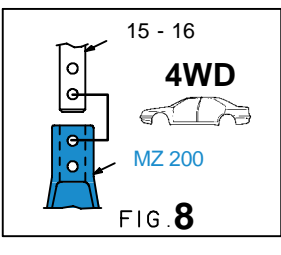
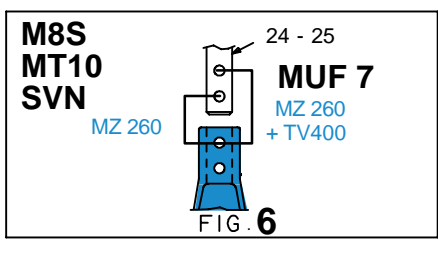
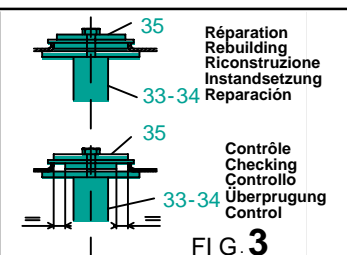
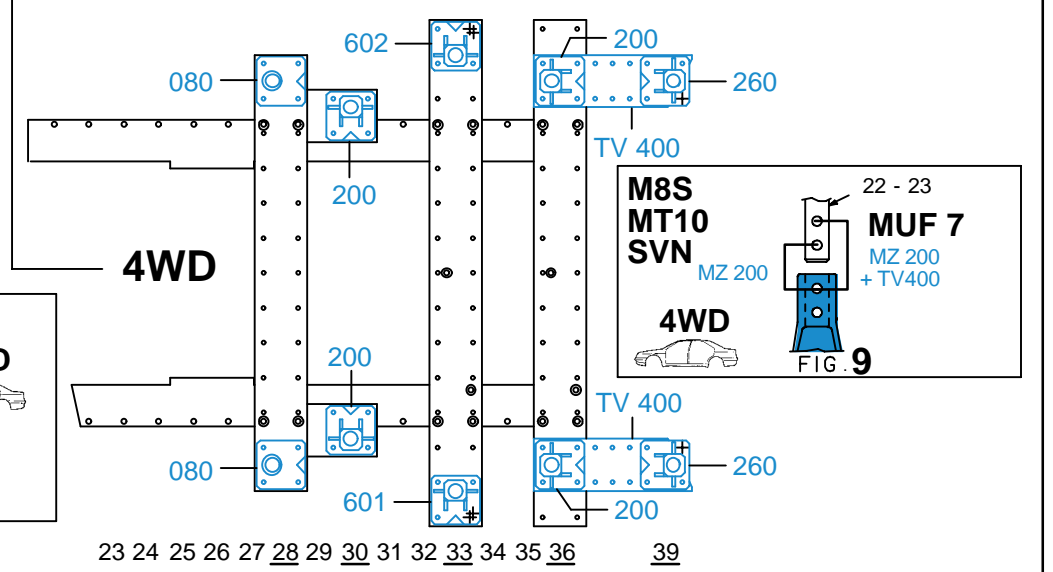
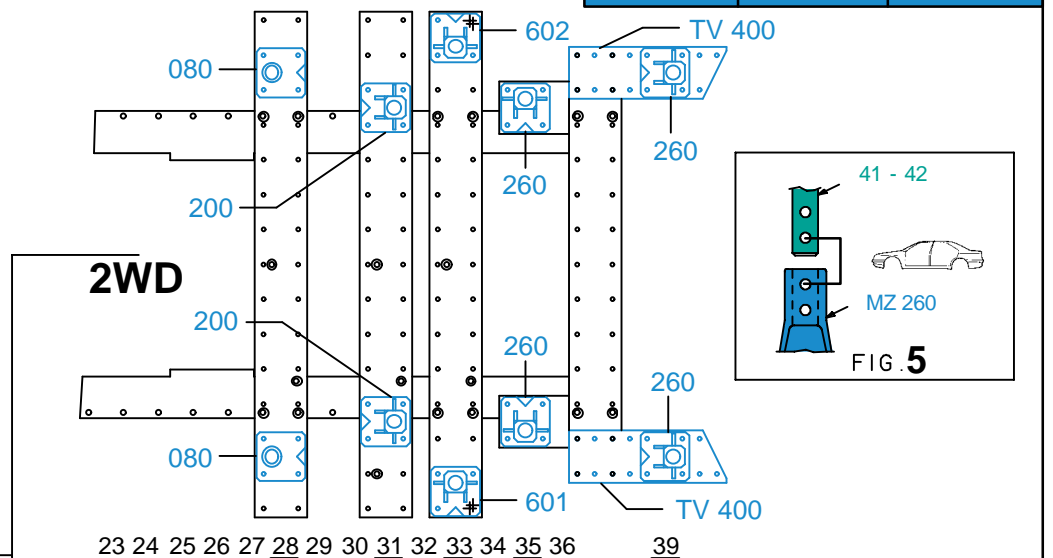
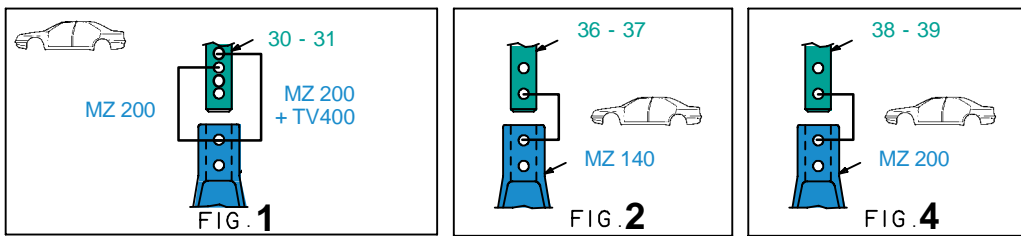

805.309-RVA3-1 | 00

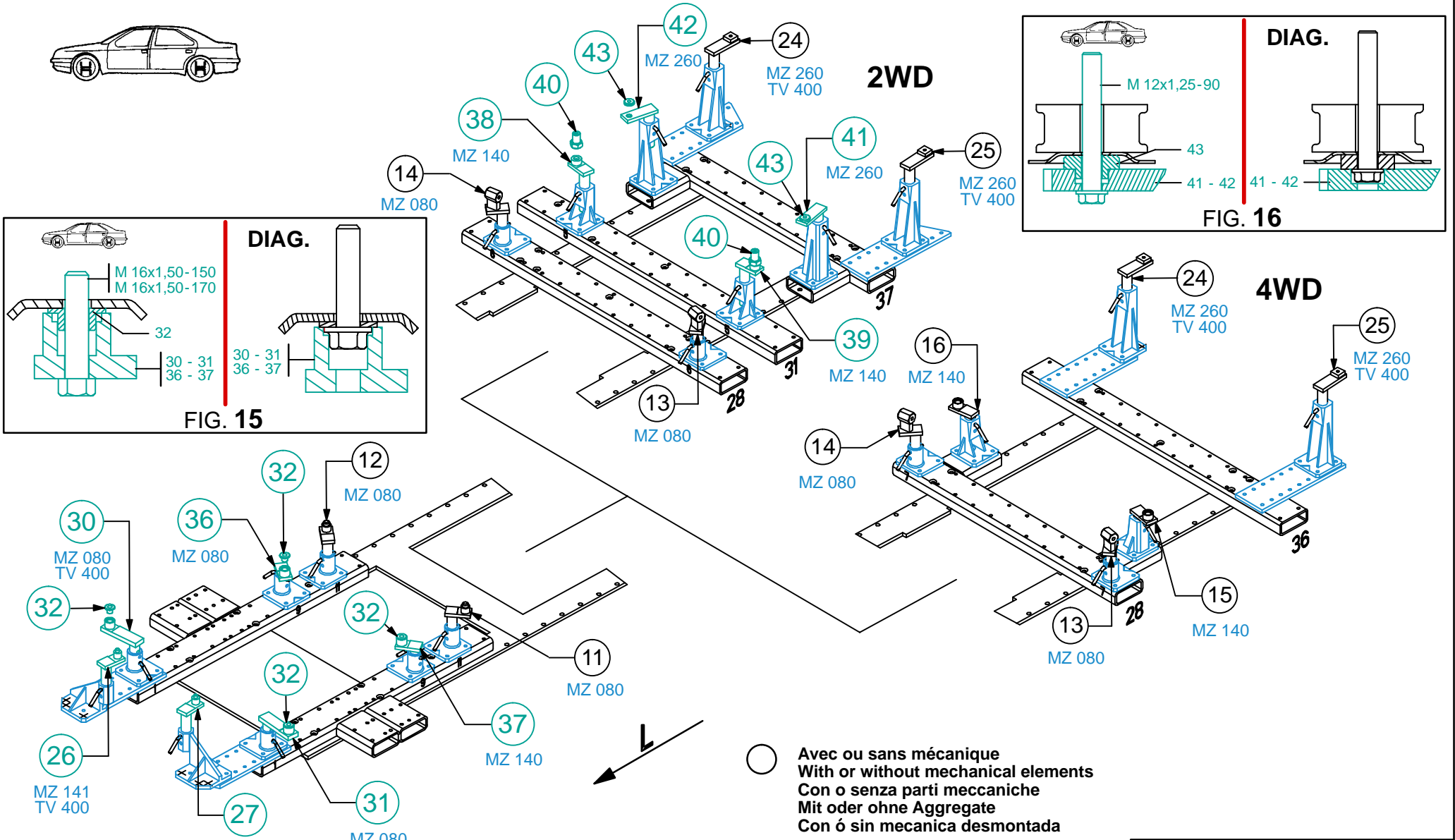

TOYOTA

805.309

37 Kg | 11.02.2004 | 434-D-60D

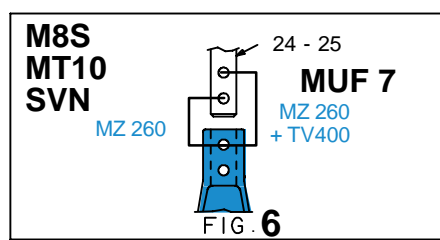
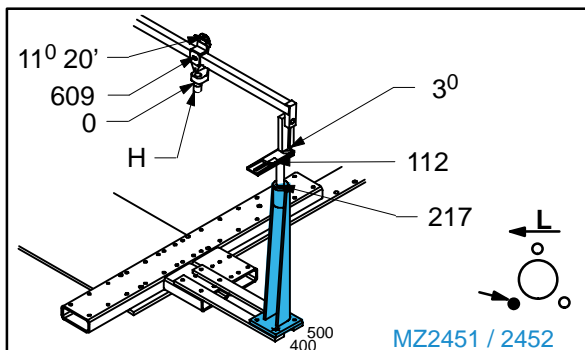
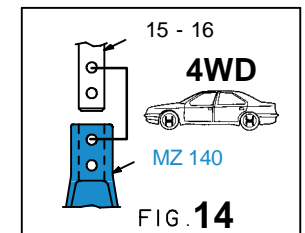
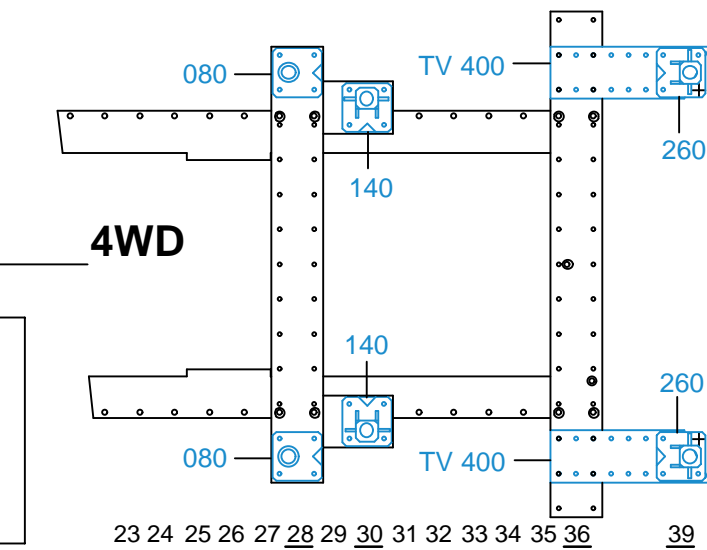
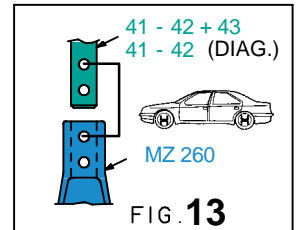
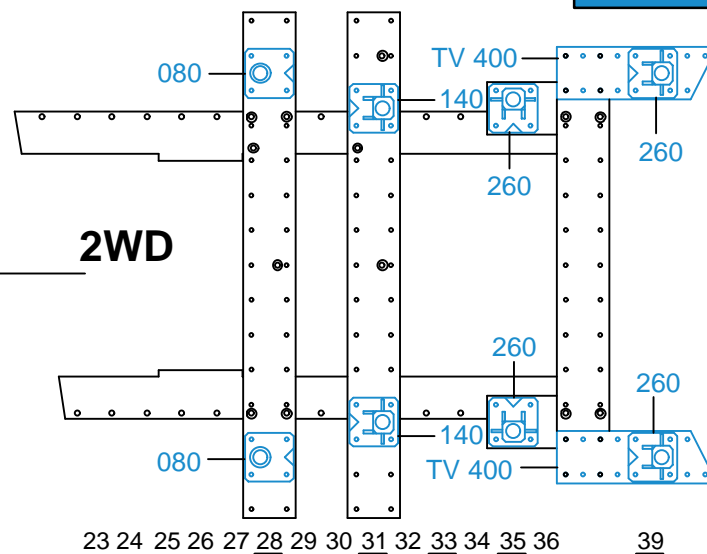
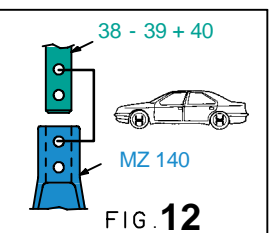
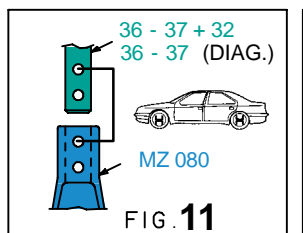
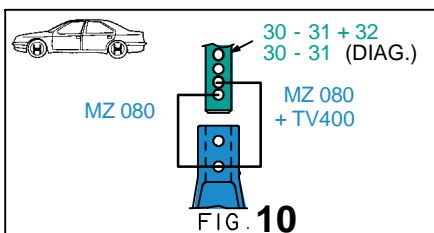

805.309-RVA3-1 | 00