

REP.	REFERENCE	PDS	NB	MZ
55	784.7055	3,0	1	200
56	784.7056	3,0	1	200
57	784.7057	3,0	1	200
58	784.7058	3,0	1	200
59	784.7059	1,7	1	141
60	784.7060	1,7	1	142
61	784.7061	2,6	1	601
62	784.7062	2,6	1	602
63	784.7063	1,3	2	
64	784.7064	1,6	1	080
65	784.7065	1,6	1	080
66	784.7066	2,8	1	200
67	784.7067	2,8	1	200
68	784.7068	1,8	1	
69	784.7069	1,8	1	
	V.32	0,1	2	
	V.11	0,1	2	

M 6-16	6
M 8-25	2
M 10-25	4
M 10-60	2
M 12-25	2
M 12-40	2
M 14-140	4
LU 6	6
MU 12	2

complément au
complementary set to
complemento al
zusatz zu

784.300

VOLVO

784.307

37 Kg | 26.09.2002 | 439-D-10G

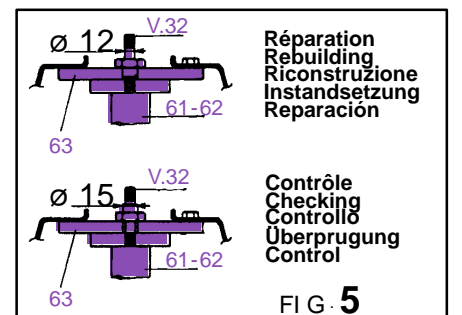
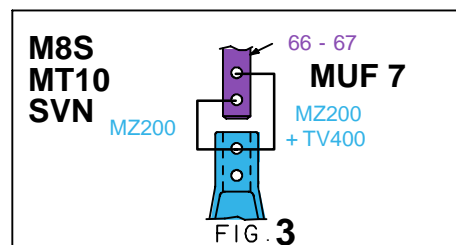
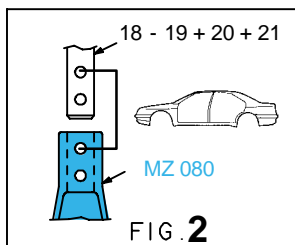
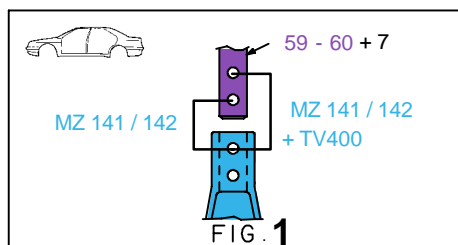
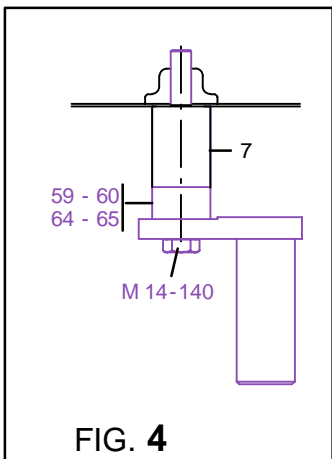
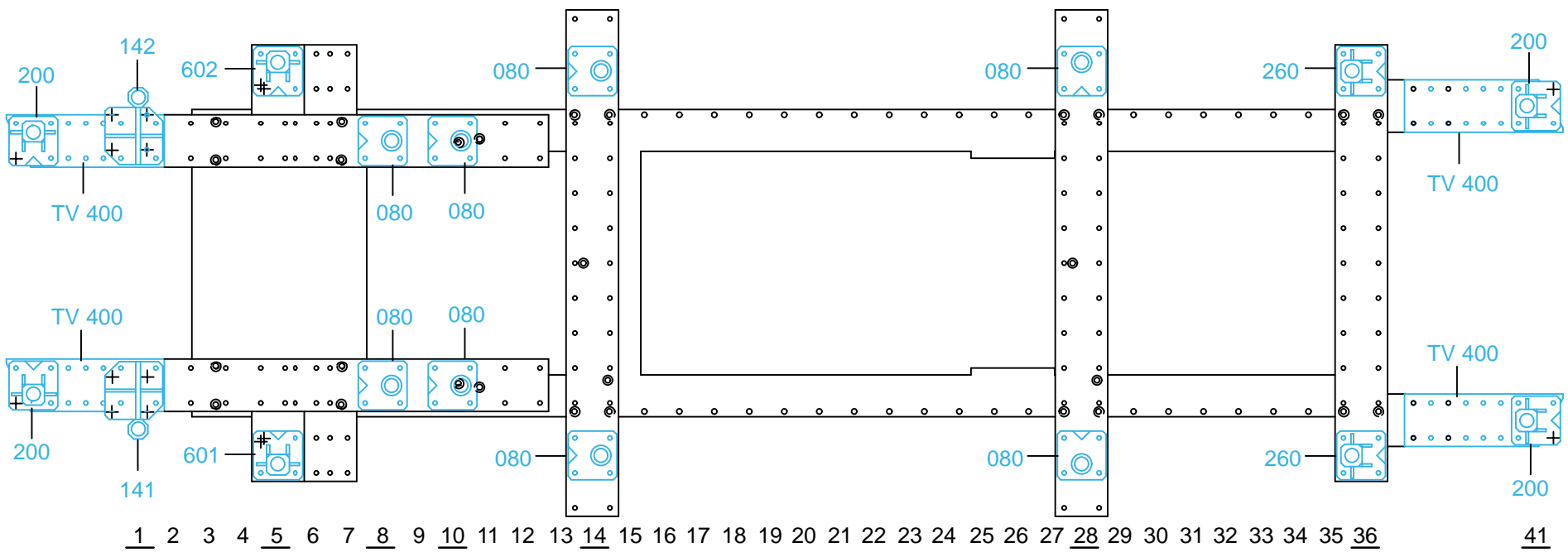

784.307-RVA3-1 | 00

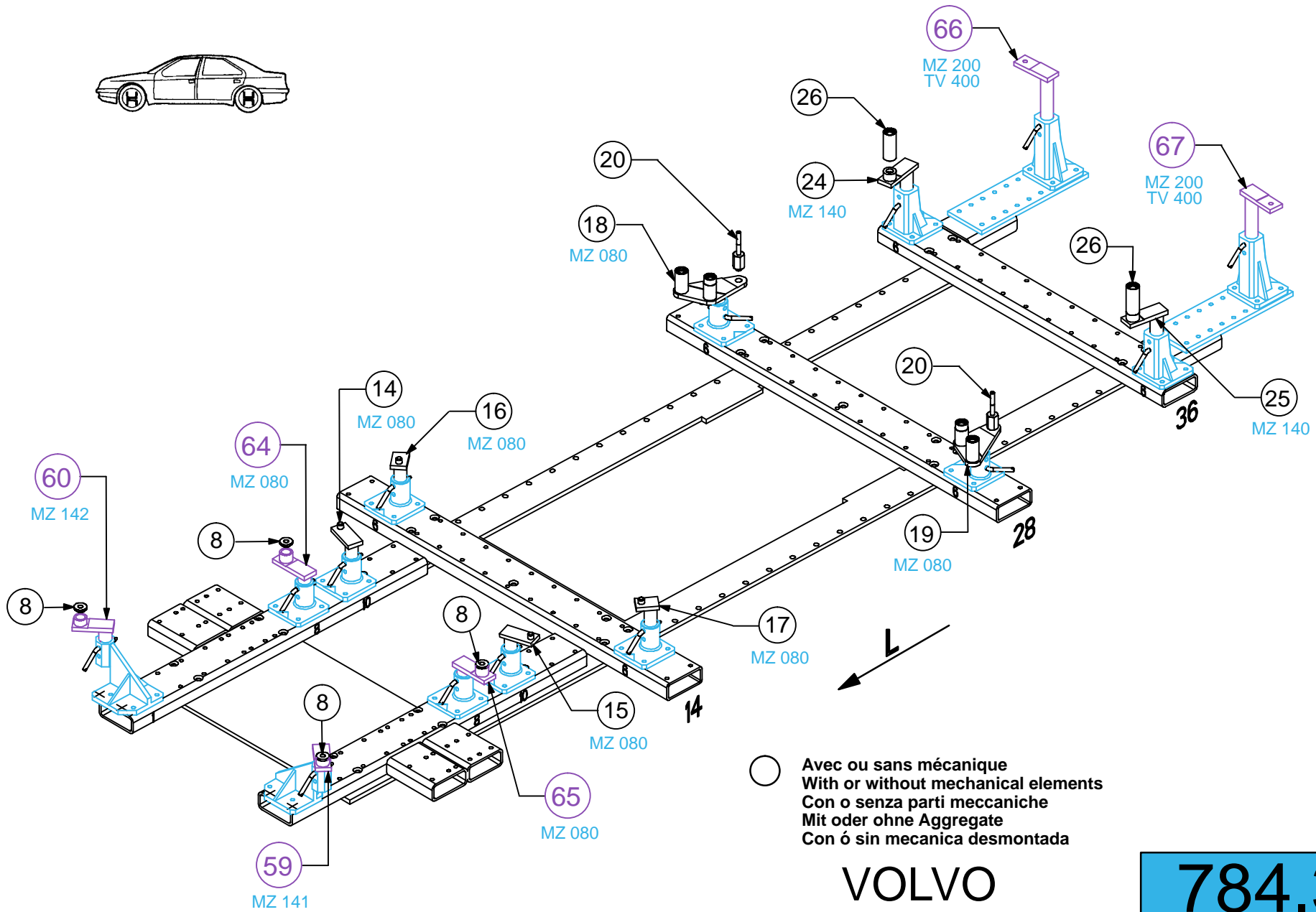
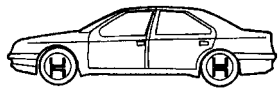

○ Avec ou sans mécanique
 With or without mechanical elements
 Con o senza parti meccaniche
 Mit oder ohne Aggregate
 Con ó sin mecanica desmontada

VOLVO

784.307

37 Kg | 06.03.2008 | 439-D-10H

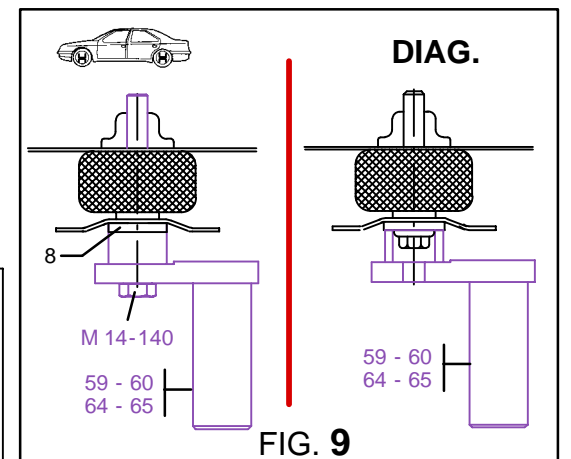
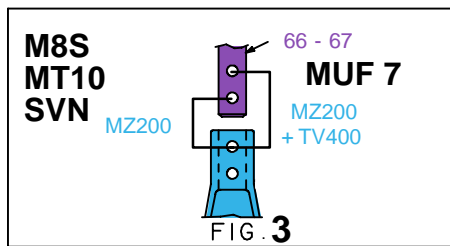
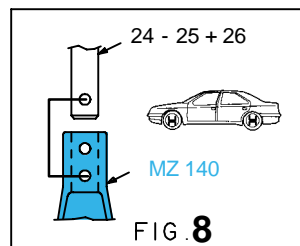
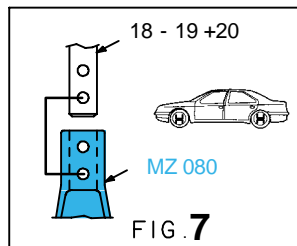
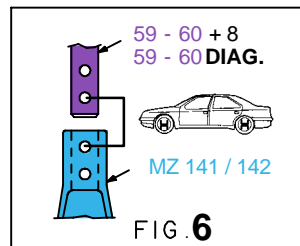
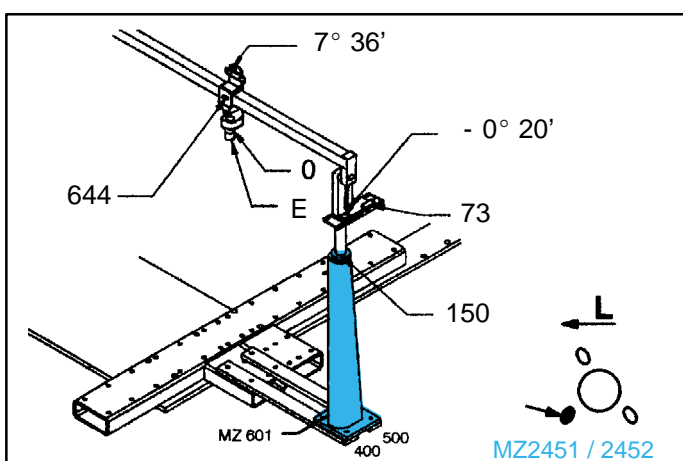
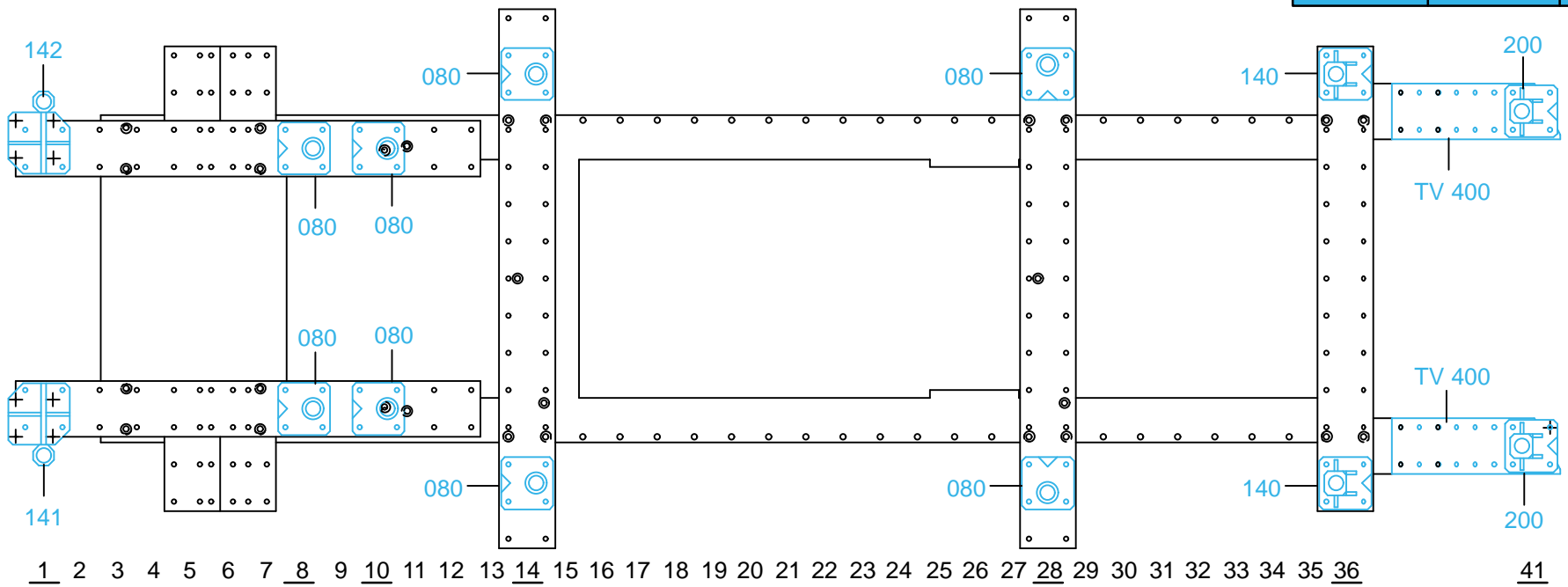

784.307-RVA3-1 | 00