

REP.	REFERENCE	PDS	NB	MZ
31	774.7031	1,9	1	080
32	774.7032	1,9	1	080
33	774.7033	0,4	2	
34	774.7034	3,4	1	260
35	774.7035	2,8	1	260
36	774.7036	2,9	1	602
37	774.7037	2,9	1	601
38	774.7038	0,7	2	
39	774.7039	2,6	1	200
40	774.7040	2,6	1	200
41	774.7041	0,2	2	

M 8-25	2
M 12-25	6
M 12-100	2

complément au  
complementary set to  
complemento al  
zusatz zu

**774.310**

**RENAULT**

**774.306**

24 Kg 01.09.2000 427-D-27Q

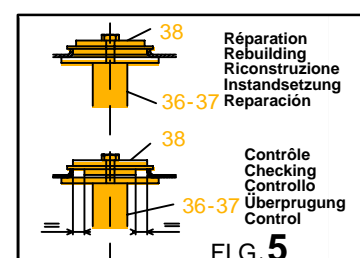
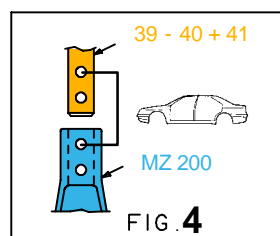
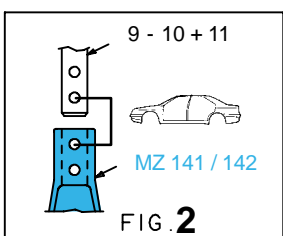
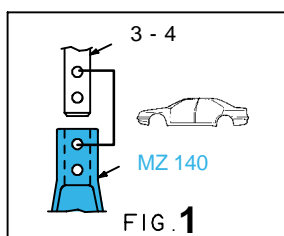
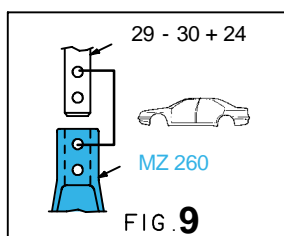
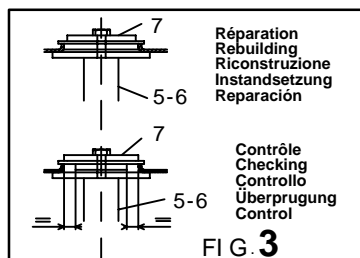
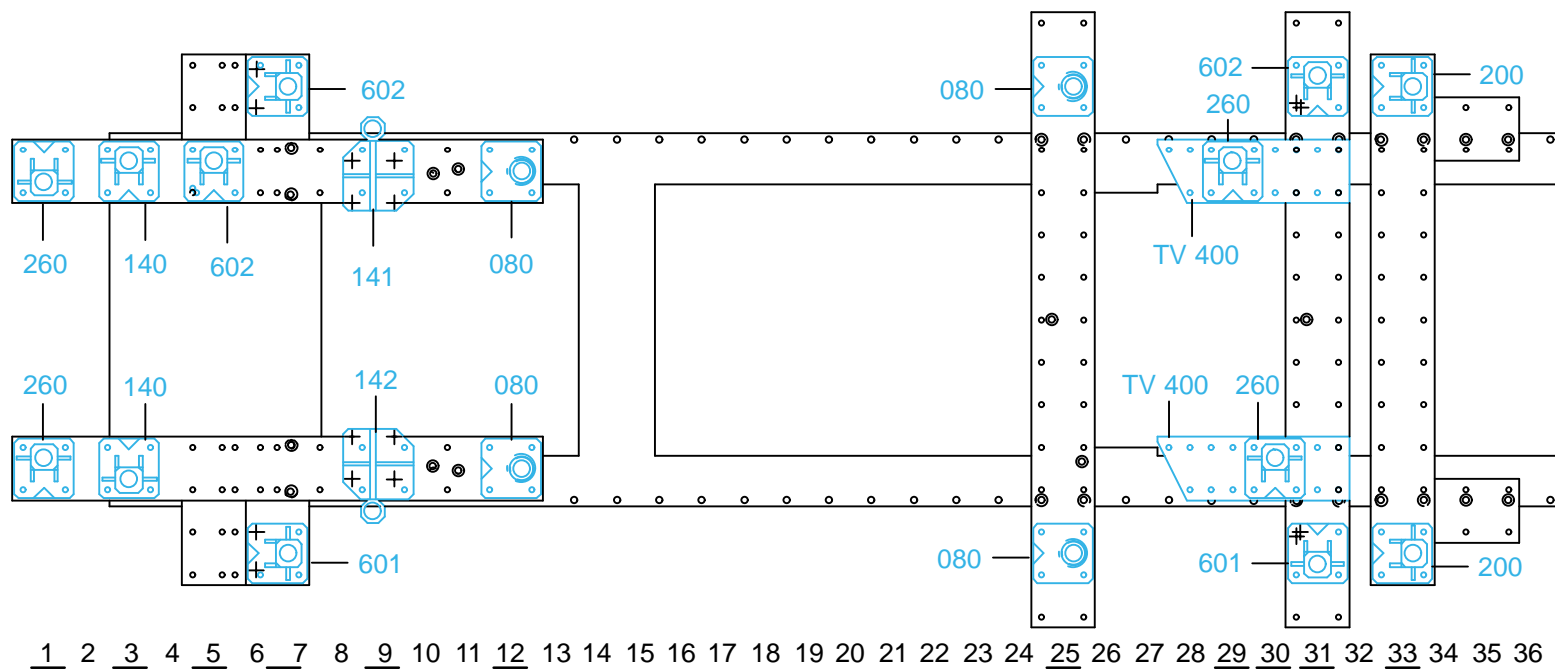

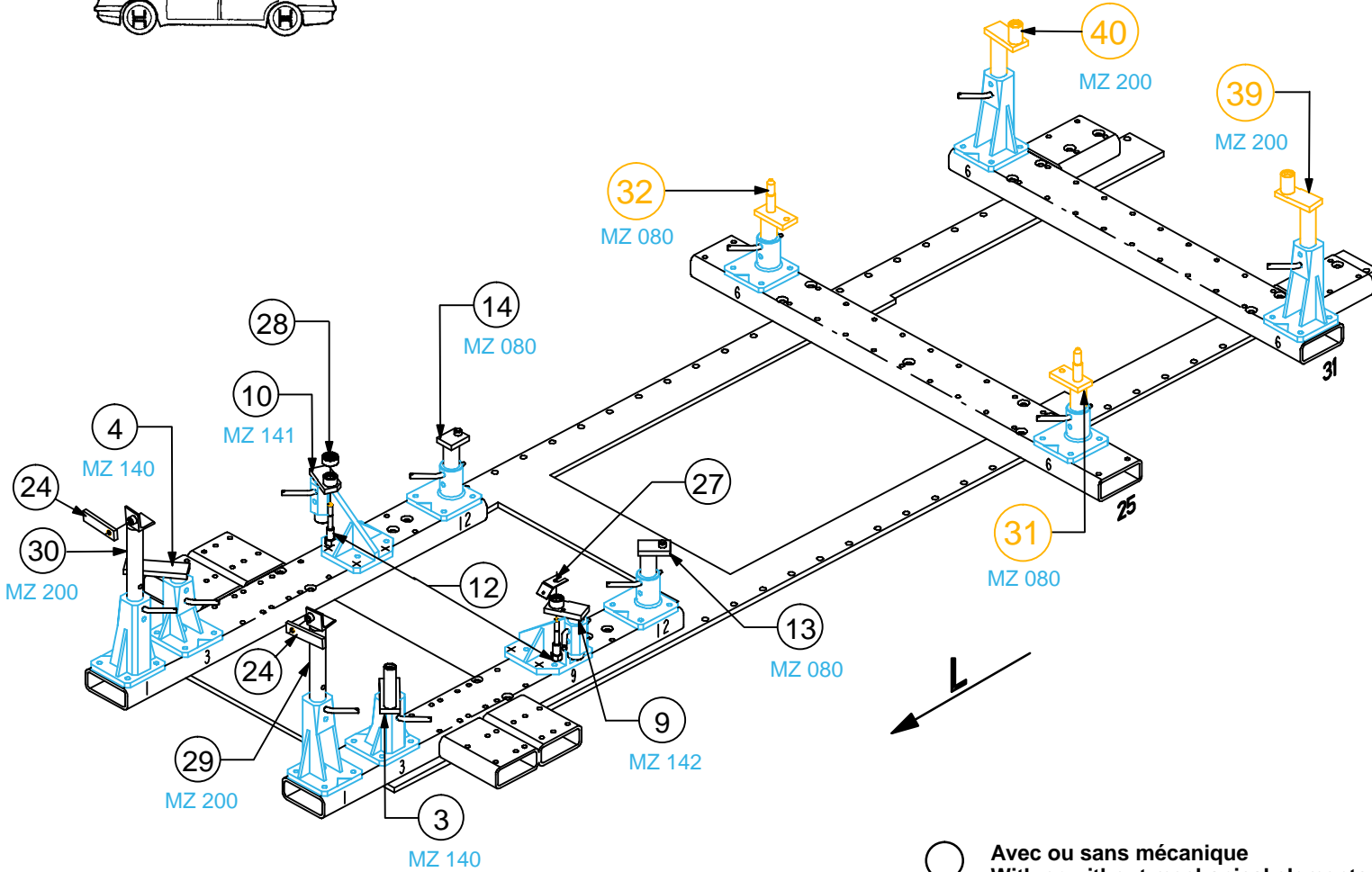
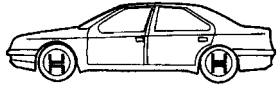

○ Avec ou sans mécanique  
 With or without mechanical elements  
 Con o senza parti meccaniche  
 Mit oder ohne Aggregate  
 Con ó sin mecánica desmontada

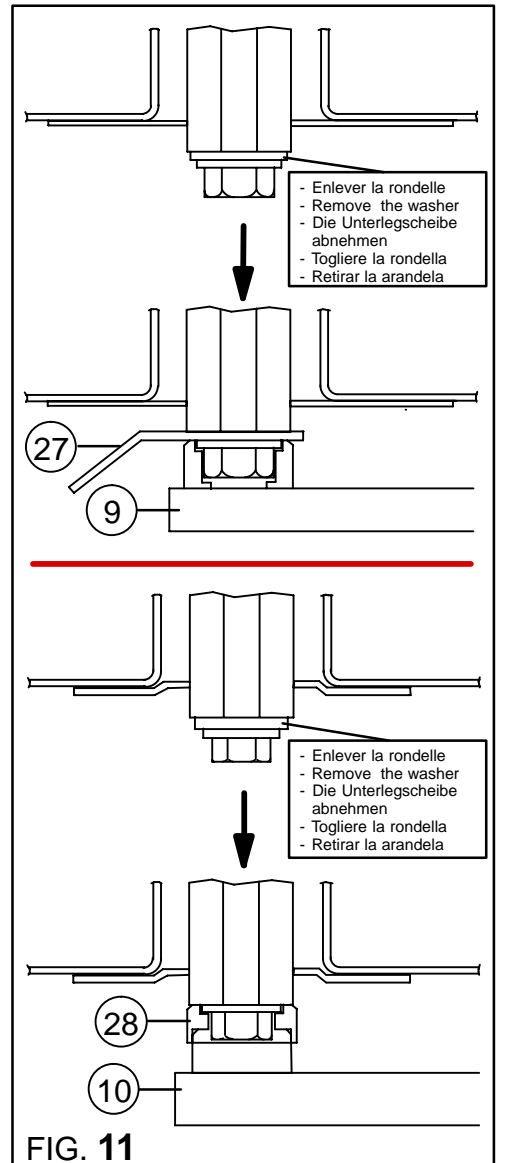

FIG. 11

**RENAULT**

**774.306**

24 Kg | 01.09.2000 | 427-D-27R

