

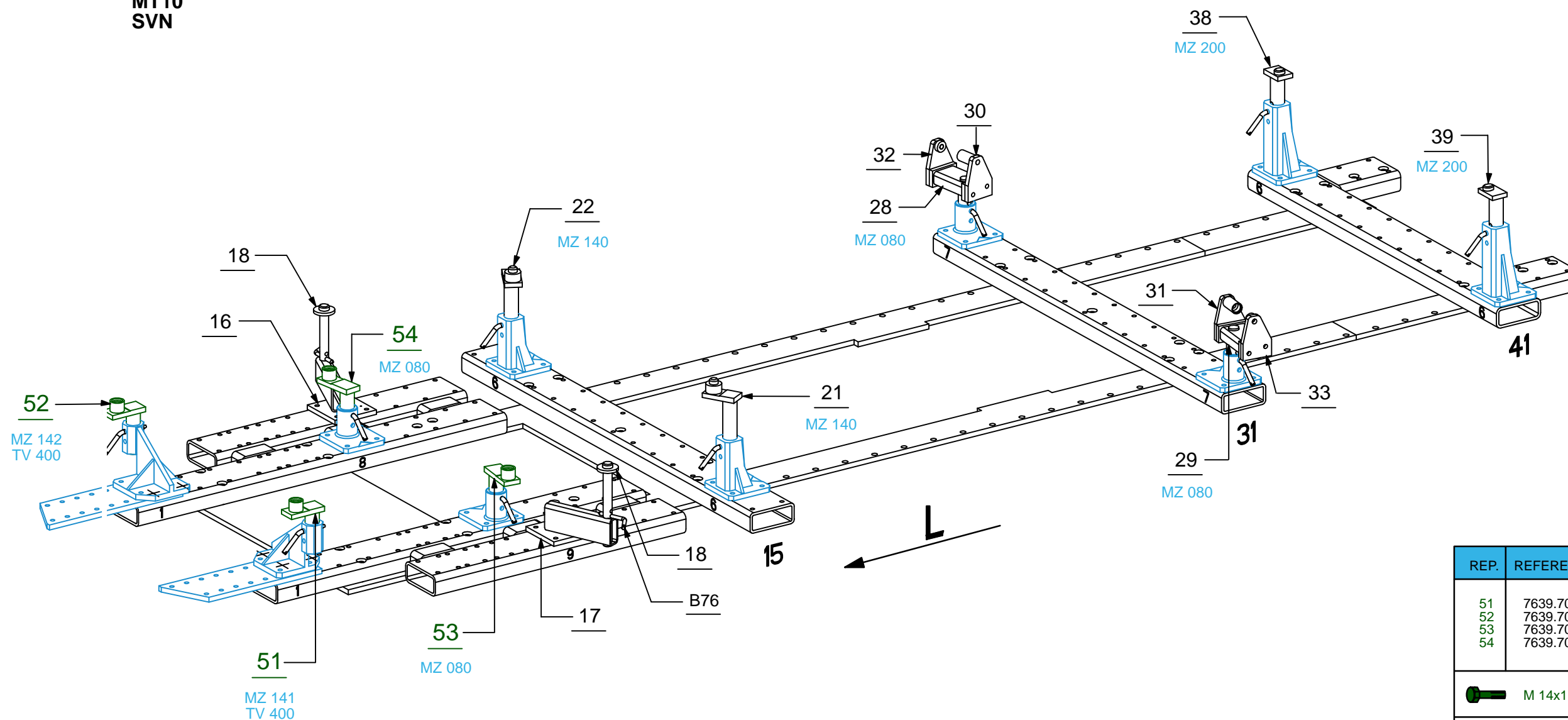

A1 / A2

**M8S
MT10
SVN**



REP.	REFERENCE	PDS	NB	MZ
51	7639.7051	1,9	1	141
52	7639.7052	1,9	1	142
53	7639.7053	2,0	1	080
54	7639.7054	2,0	1	080

 M 14x1,50-180	4
---	---

complément au
complementary set to
complemento al
zusatz zu **7639.300**

7639.309

9 Kg	15.09.2005	420-D-29Q
------	------------	-----------

7639.309-RVA3-1 00

XX Avec ou sans mécanique
With or without mechanical elements
Con o senza parti meccaniche
Mit oder ohne Aggregate
Con ó sin mecanica desmontada

MERCEDES BENZ

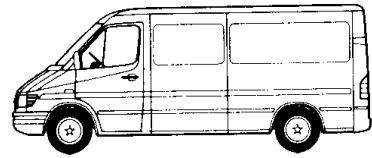

A1 / A2

**M8S
MT10
SVN**

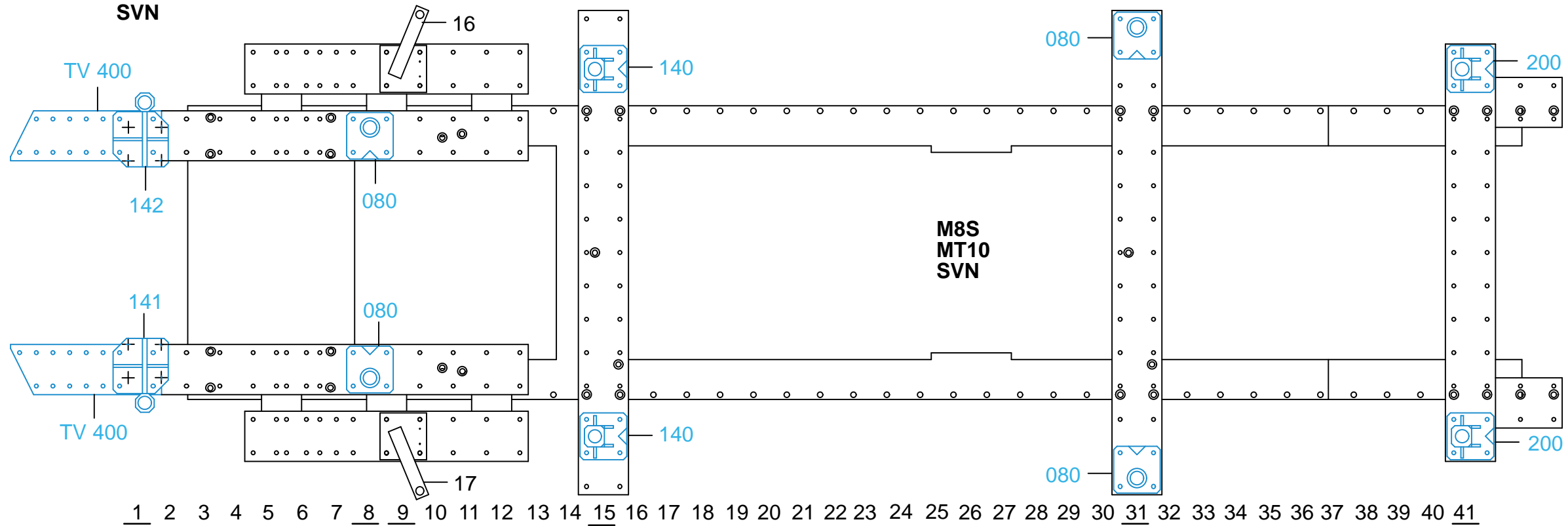

1 2 3 4 5 6 7 8 9 10 11 12 13 14 15 16 17 18 19 20 21 22 23 24 25 26 27 28 29 30 31 32 33 34 35 36 37 38 39 40 41

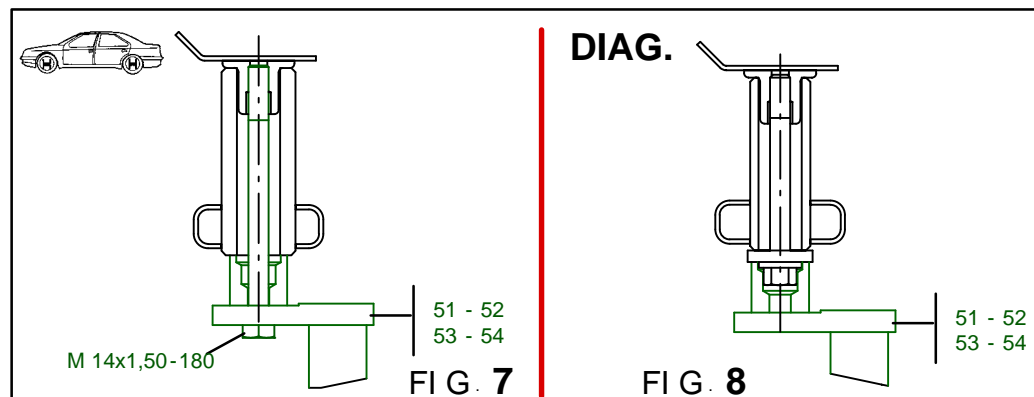
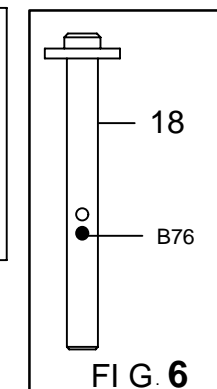
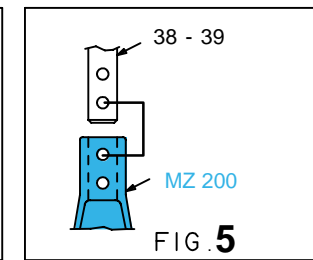
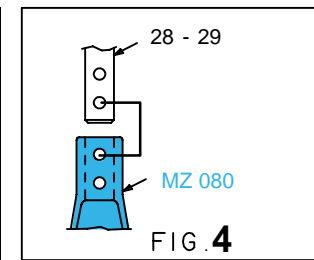
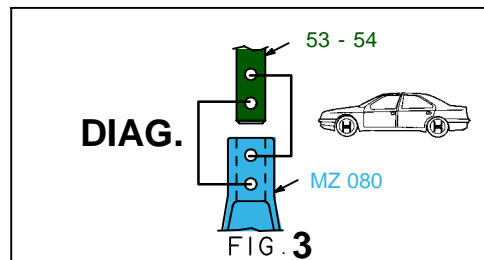
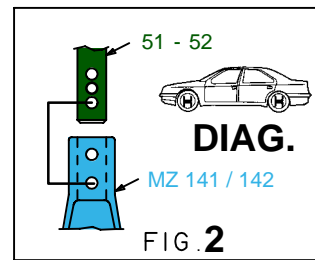
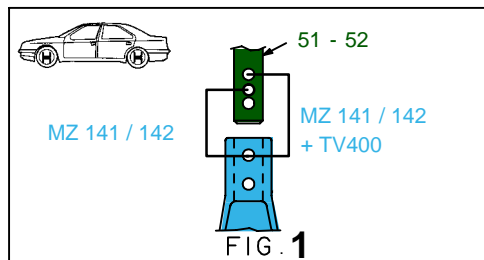

XX Avec ou sans mécanique
With or without mechanical elements
Con o senza parti meccaniche
Mit oder ohne Aggregate
Con ó sin mecánica desmontada

MERCEDES BENZ

7639.309		
9 Kg	15.09.2005	420-D-29R
7639.309-RVA3-1		00

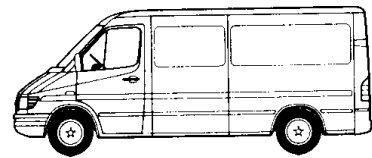

A3

**M8S
MT10
SVN**

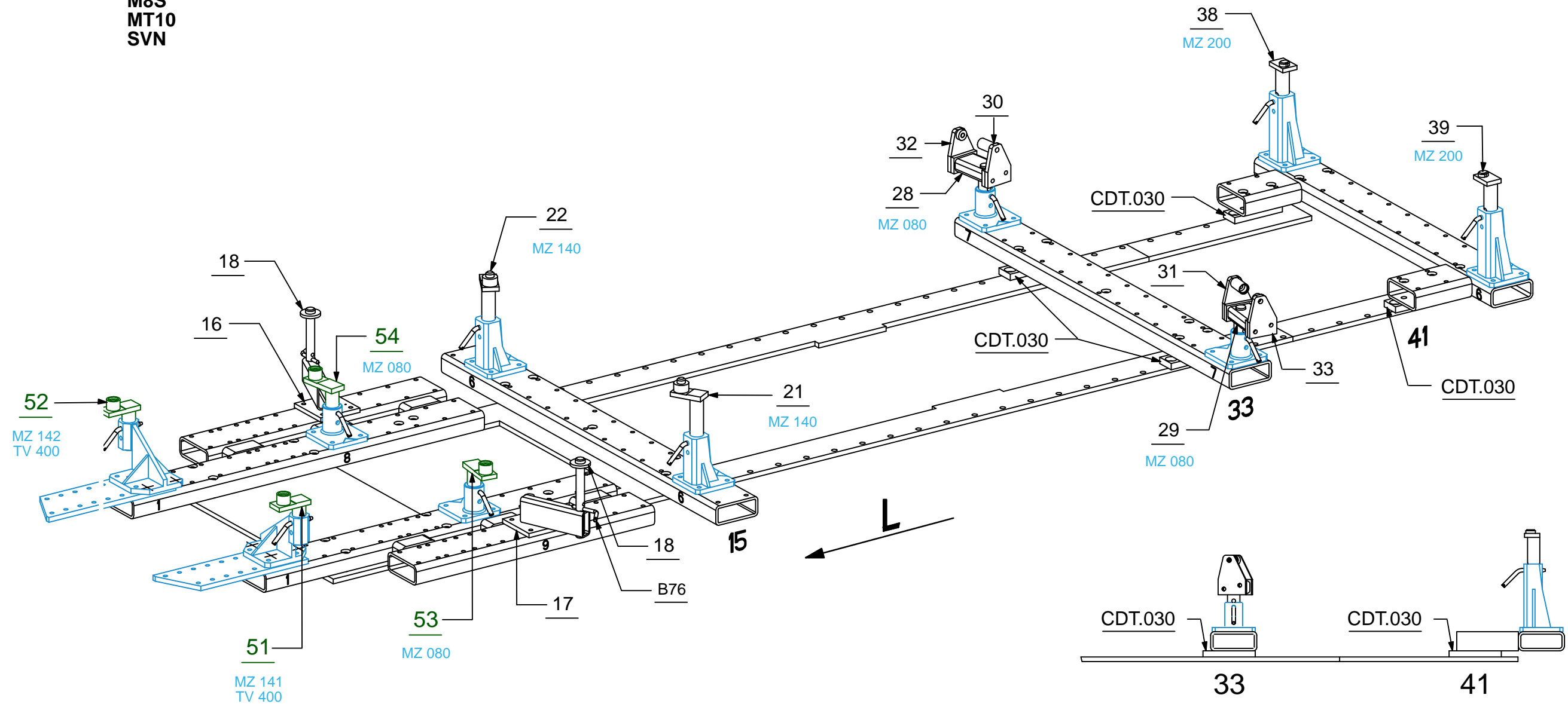

XX Avec ou sans mécanique
With or without mechanical elements
Con o senza parti meccaniche
Mit oder ohne Aggregate
Con ó sin mecanica desmontada

MERCEDES BENZ

7639.309

9 Kg	15.09.2005	420-D-29S
7639.309-RVA3-2		00

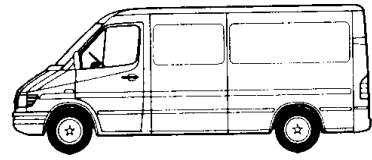

A3

**M8S
MT10
SVN**

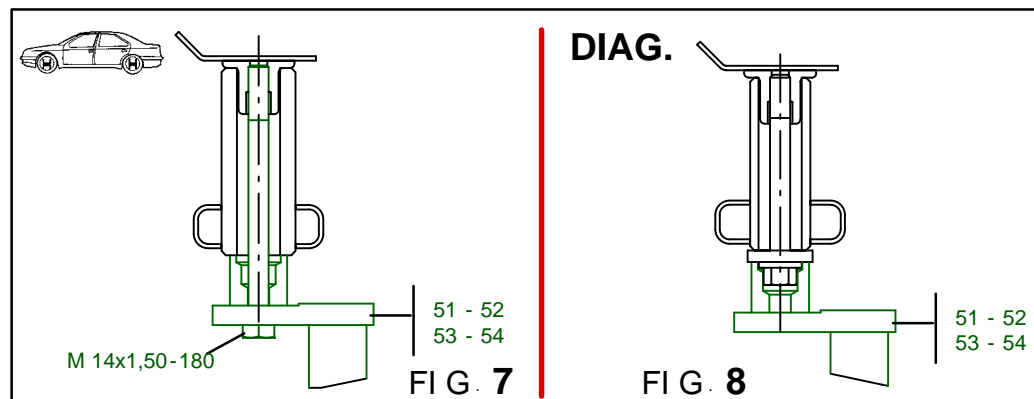
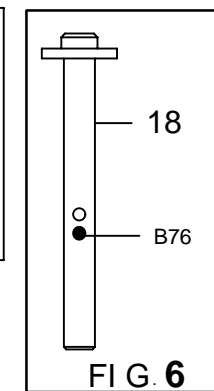
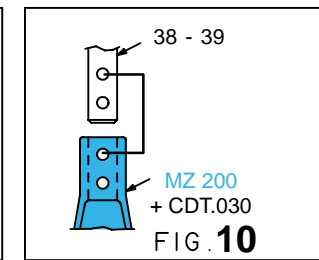
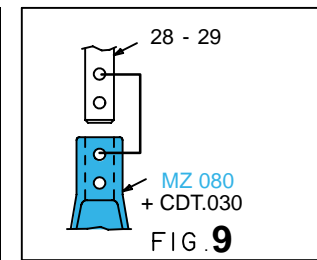
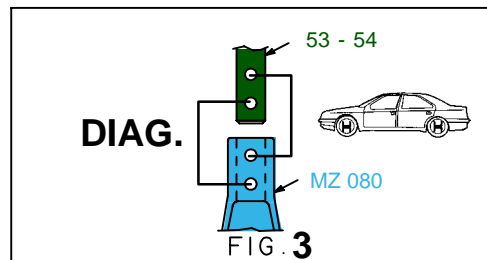
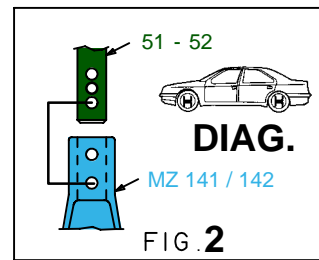
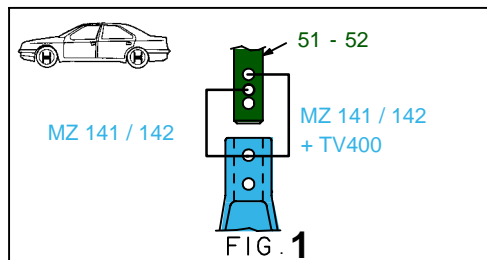
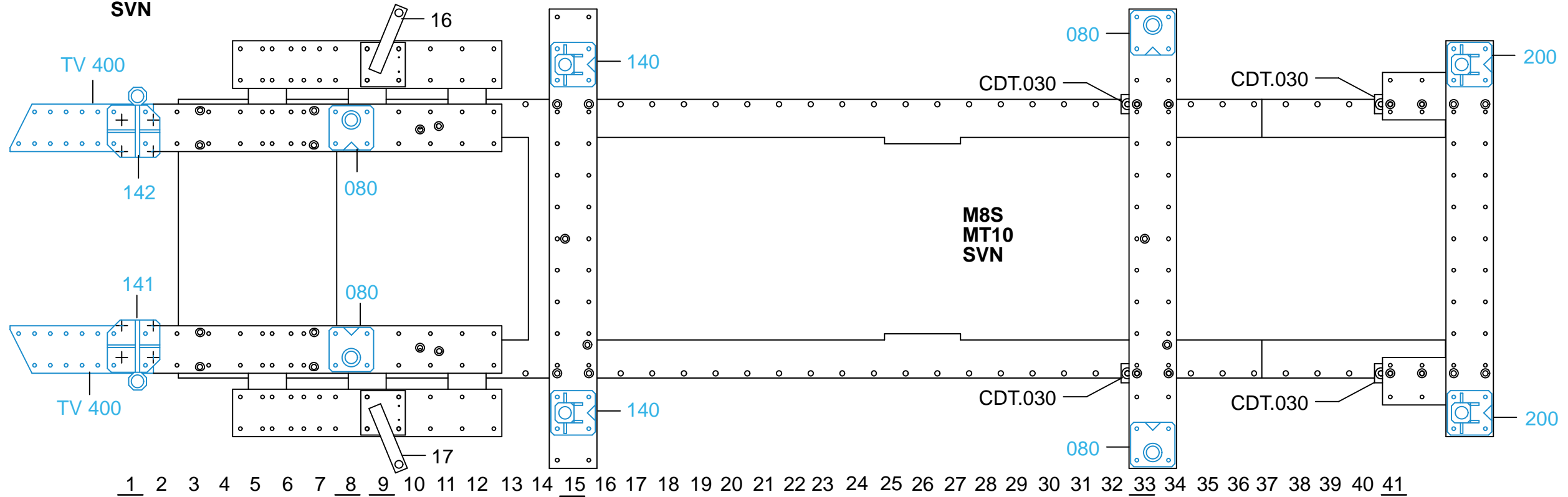

XX Avec ou sans mécanique
With or without mechanical elements
Con o senza parti meccaniche
Mit oder ohne Aggregate
Con ó sin mecanica desmontada

MERCEDES BENZ

7639.309		
9 Kg	15.09.2005	420-D-29T
7639.309-RVA3-2		00