

REP.	REFERENCE	PDS	NB	MZ
1	753.7001	2,5	1	142
2	753.7002	2,5	1	141
3	753.7003	2,9	1	140
4	753.7004	2,9	1	140
5	753.7005	0,4	6	
6	753.7006	0,03	2	
7	753.7007	1,6	1	260/080
8	753.7008	1,6	1	260/080
9	753.7009	1,2	2	
10	753.7010	2,4	1	602
11	753.7011	2,4	1	601
12	753.7012	0,6	2	
13	753.7013	2,2	1	080
14	753.7014	2,2	1	080
15	753.7015	2,3	1	080
16	753.7016	2,3	1	080
17	753.7017	3,4	1	140
18	753.7018	3,4	1	140
19	753.7019	0,7	2	
20	753.7020	0,6	2	
21	753.7021	3,5	1	200
22	753.7022	3,5	1	200
23	753.7023	2,9	1	200
24	753.7024	2,9	1	200
25	753.7025	3,5	1	260
26	753.7026	3,5	1	260
27	753.7027	2,6	1	
28	753.7028	2,6	1	
29	753.7029	2,2	1	260
30	753.7030	2,2	1	260
31	753.7031	2,5	1	200
32	753.7032	2,5	1	200

M 8x30	2
M 10x30	2
M 10x40	2
M 10.125x30	4
M 10.125x50	4
M 12x20	4
M 12x25	6
M 12x30	2
M 12x60	2
M 12x80	2
M 12.150x40	2
M 12.150x100	2
M 12.150x120	2
M 12.150x140	2
M 12.150x170	2

M 8	2
M 12	2
LLU 12	2

○ Avec ou sans mécanique  
With or without mechanical elements  
Con o senza parti meccaniche  
Mit oder ohne Aggregate  
Con ó sin mecanica desmontada

**SAAB**

**753.300**

79 Kg 14.10.97 430-D-5A

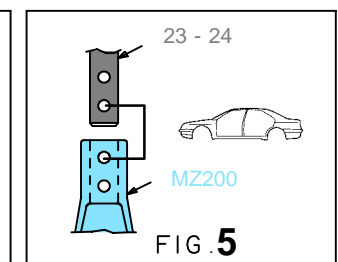
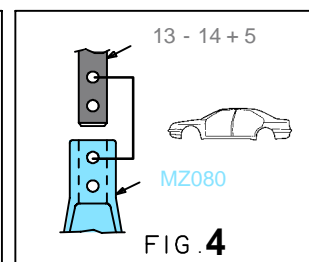
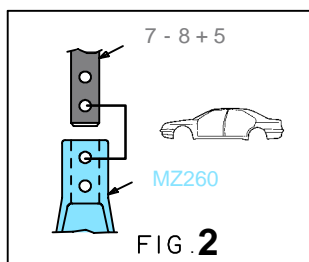
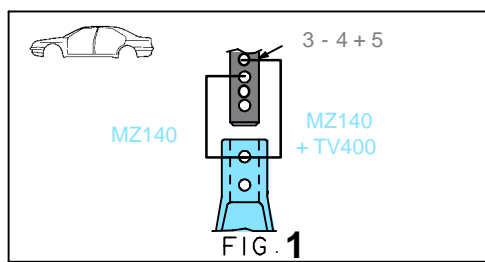
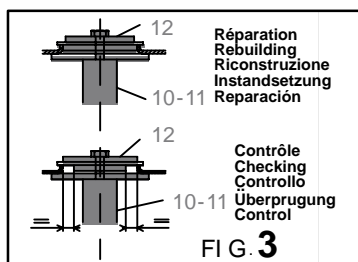
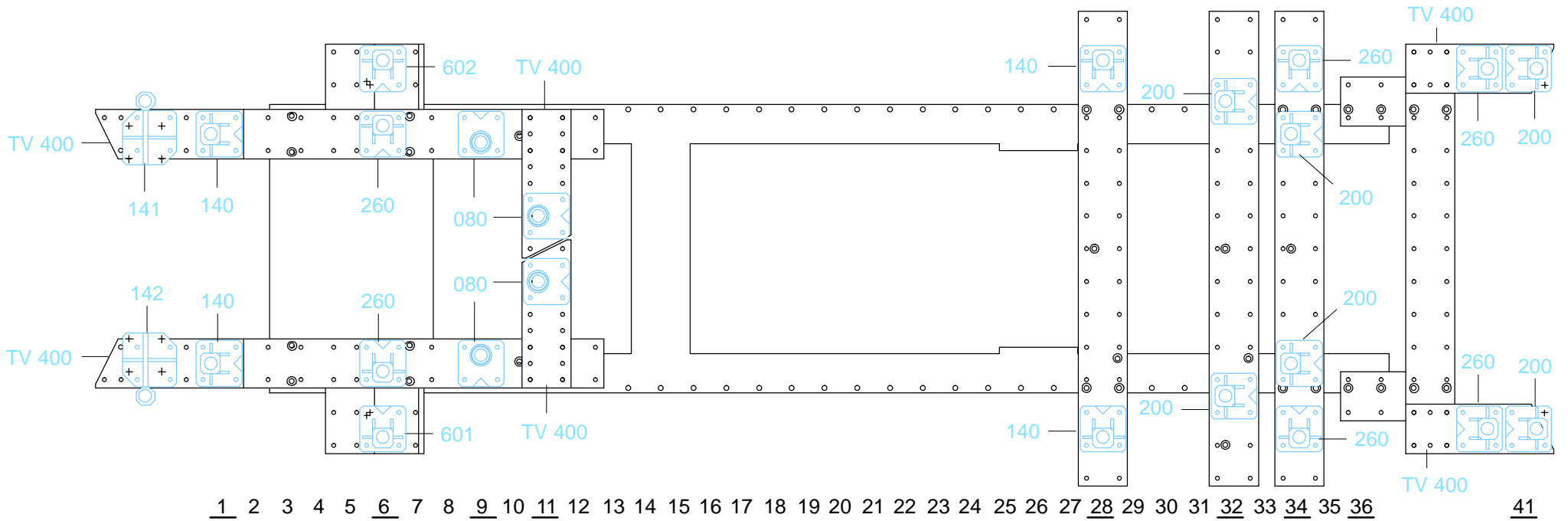

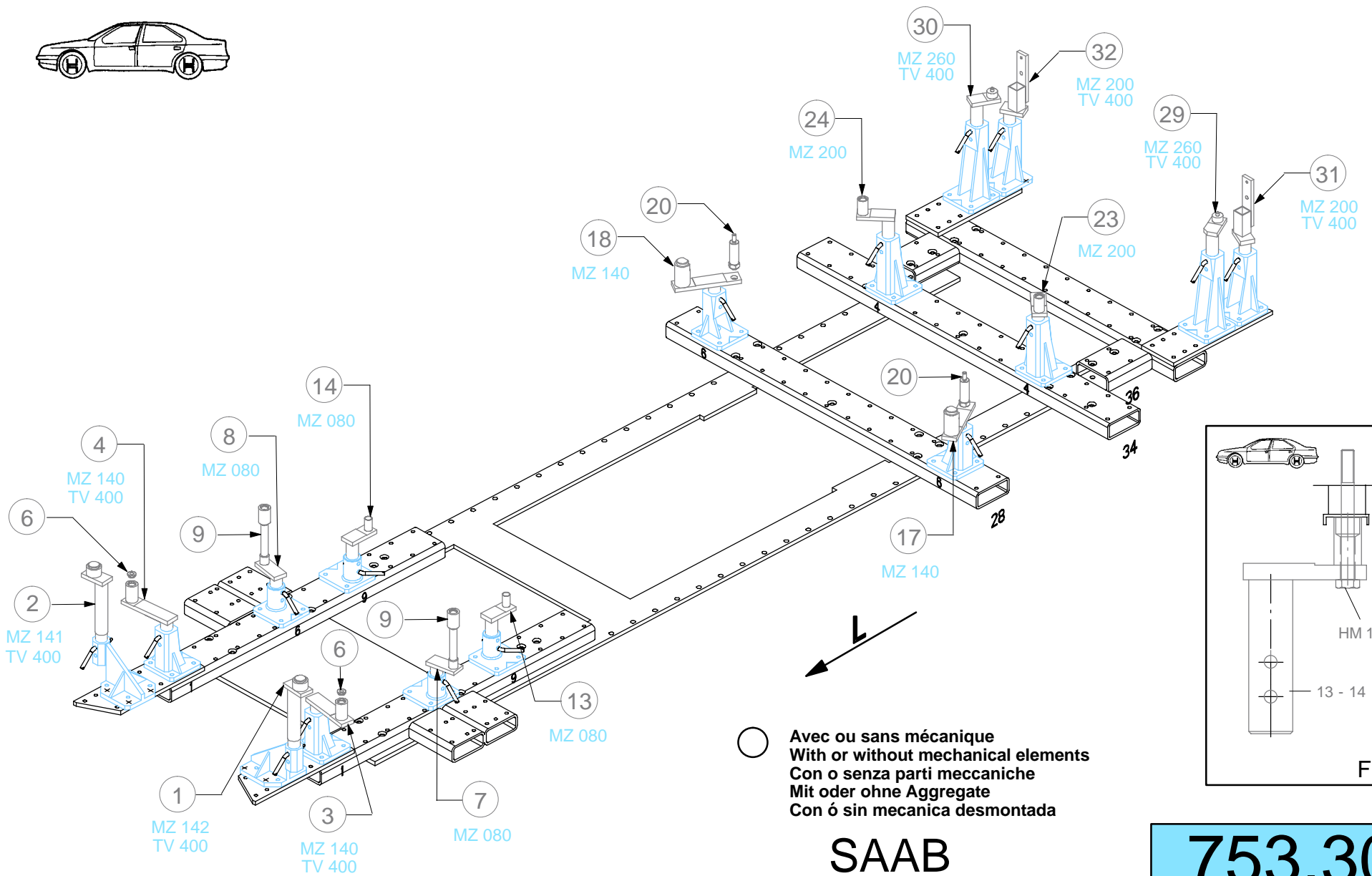

○ Avec ou sans mécanique  
 With or without mechanical elements  
 Con o senza parti meccaniche  
 Mit oder ohne Aggregate  
 Con ó sin mecánica desmontada

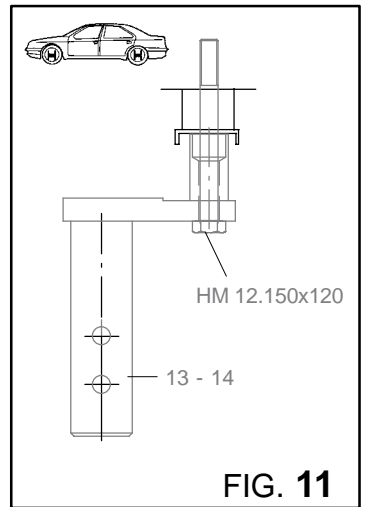

**753.300**

79 Kg | 03.11.97 | 430-D-5B

**SAAB**

