

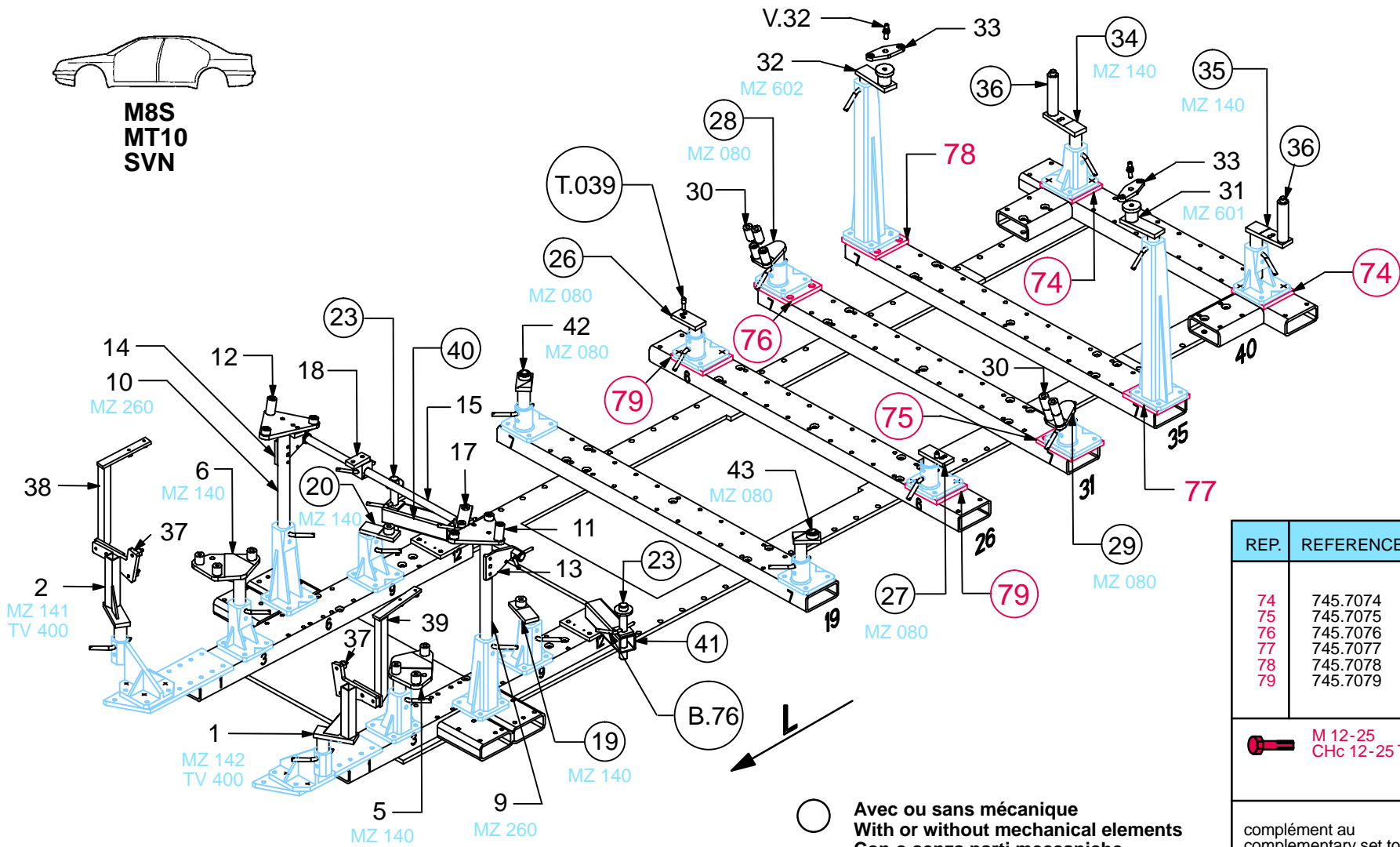

**M8S
MT10
SVN**



○ Avec ou sans mécanique
With or without mechanical elements
Con o senza parti meccaniche
Mit oder ohne Aggregate
Con ó sin mecanica desmontada

REP.	REFERENCE	PDS	NB	MZ
74	745.7074	2,4	2	
75	745.7075	2,8	1	
76	745.7076	2,8	1	
77	745.7077	2,8	1	
78	745.7078	2,8	1	
79	745.7079	2,4	2	

M 12-25 CHc 12-25 TB	24 22
-------------------------	----------

complément au
complementary set to
complemento al
zusatz zu

752.300

752.309

22 Kg	25.06.99	403-D-12M
-------	----------	-----------

VAS 5035/2

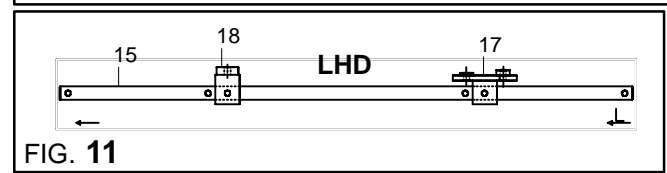
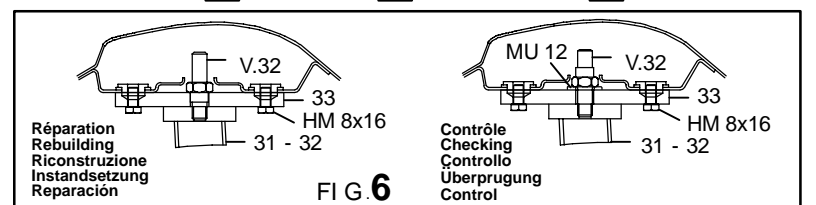
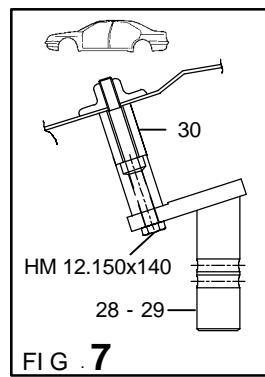
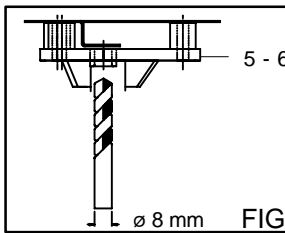
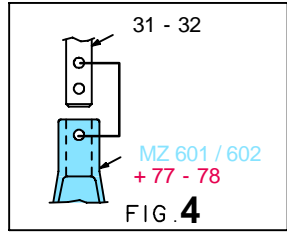
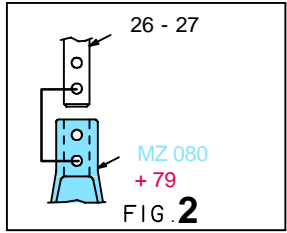
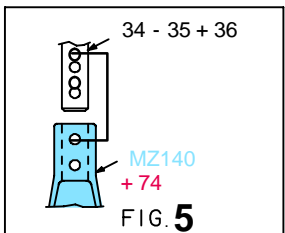
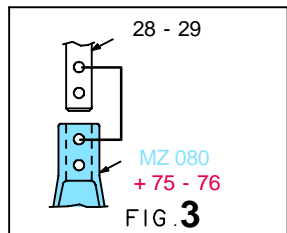
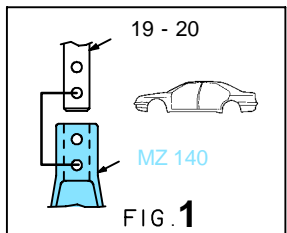
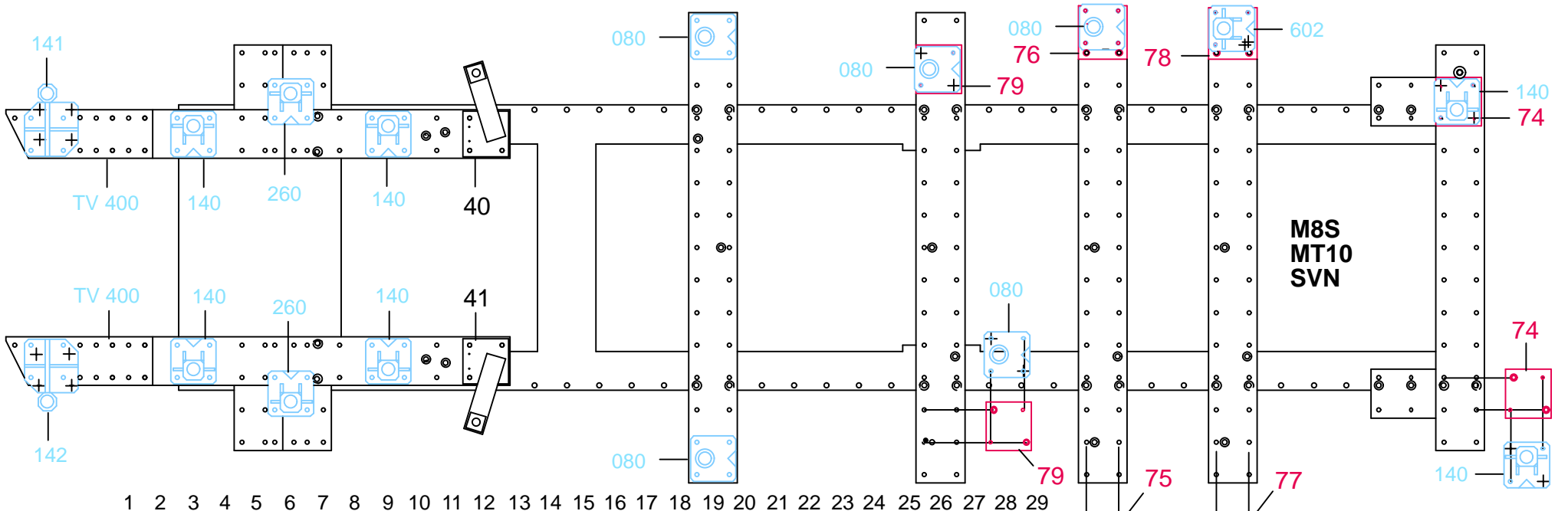

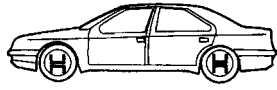

**M8S
MT10
SVN**

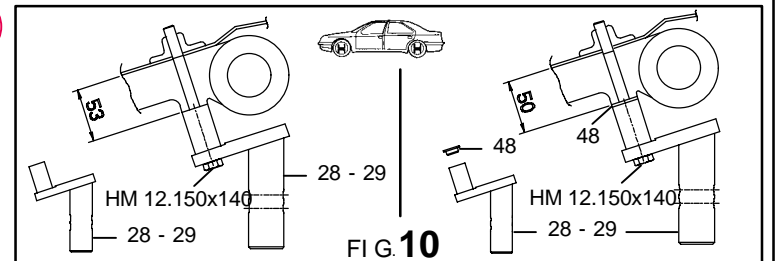
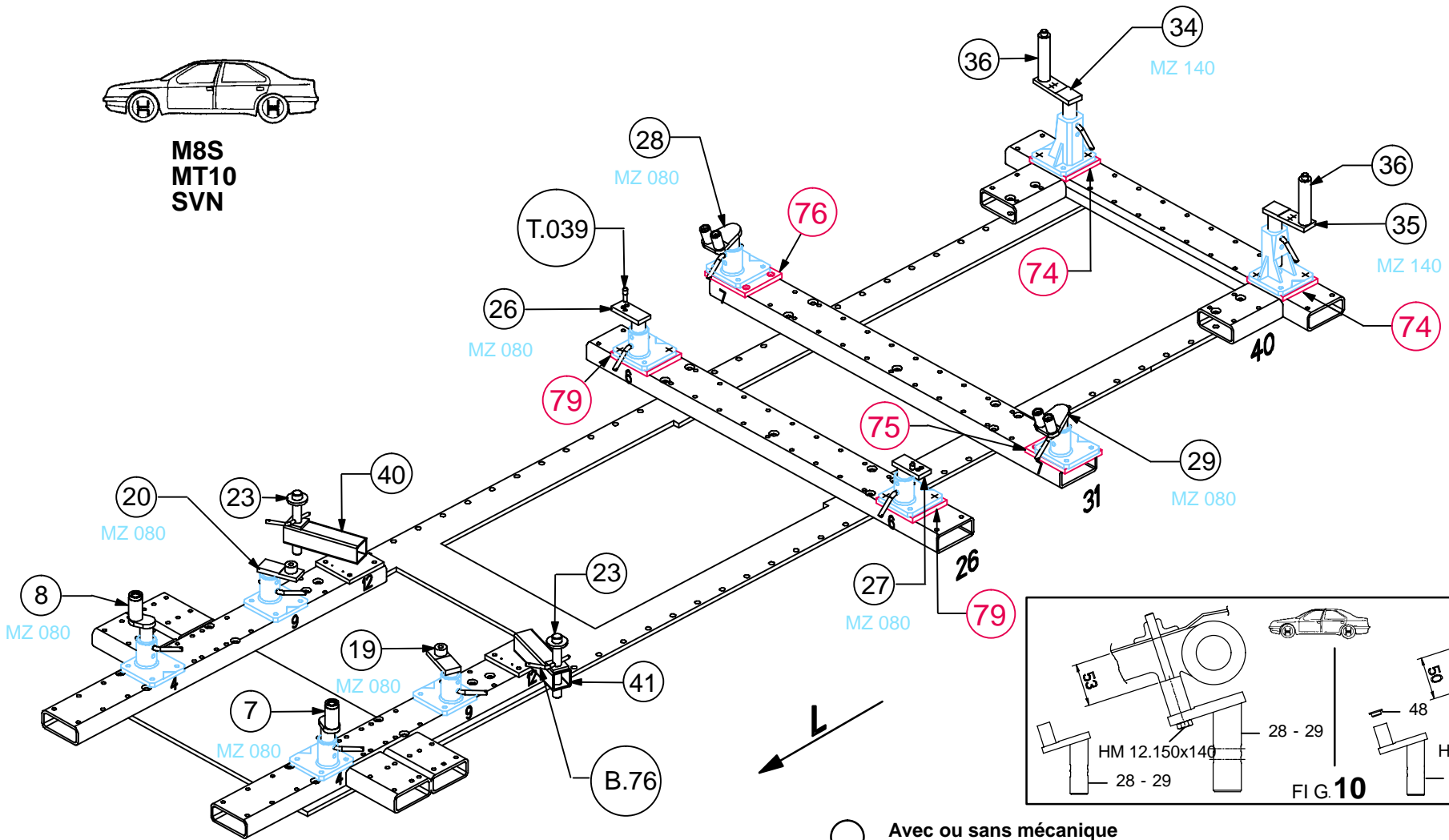

○ Avec ou sans mécanique
With or without mechanical elements
Con o senza parti meccaniche
Mit oder ohne Aggregate
Con ó sin mecanica desmontada

VAS 5035/2



752.309

22 Kg | 25.06.99 | 403-D-12N

