

REP.	REFERENCE	PDS	NB	MZ
37	745.7037	0,08	4	080 080
38	745.7038	1,5	1	
39	745.7039	1,5	1	
40	745.7040	4,2	1	
41	745.7041	4,2	1	
42	745.7042	1,9	1	
43	745.7043	1,9	1	
44	745.7044	2,8	1	
45	745.7045	2,8	1	
46	745.7046	2,7	1	
47	745.7047	2,7	1	
	T.039	0,05	2	
	B.76	0,1	2	

- M 6x35
M 12x25
CHc 12x25 TB 4
8
8
- M 10 2

complément au
complementary set to
complemento al
zusatz zu **745.300**
745.400

745.309
28 Kg 11.02.97 403-D-12A

VAS 5022/1



○ Avec ou sans mécanique
With or without mechanical elements
Con o senza parti meccaniche
Mit oder ohne Aggregate
Con ó sin mecanica desmontada

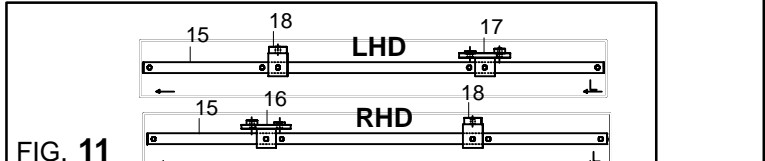
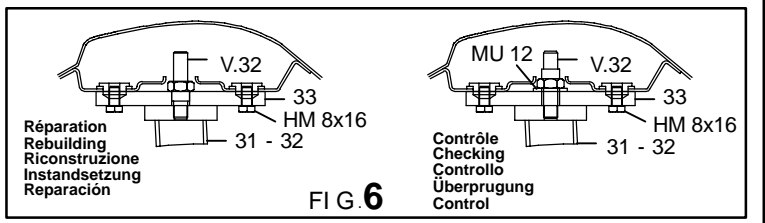
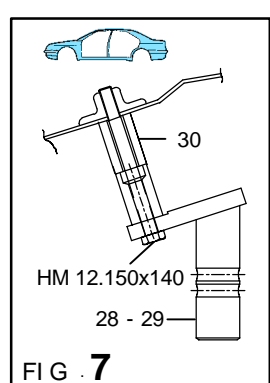
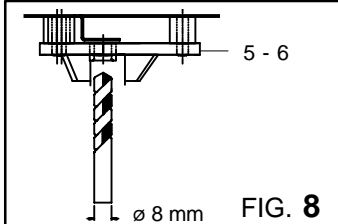
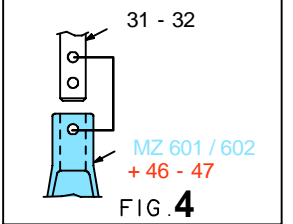
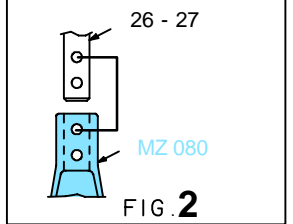
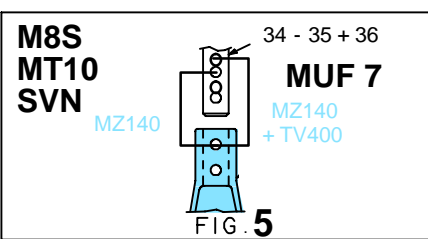
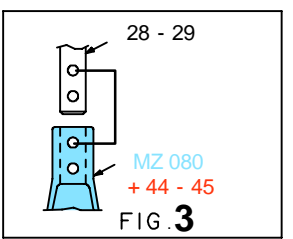
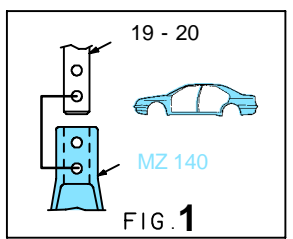
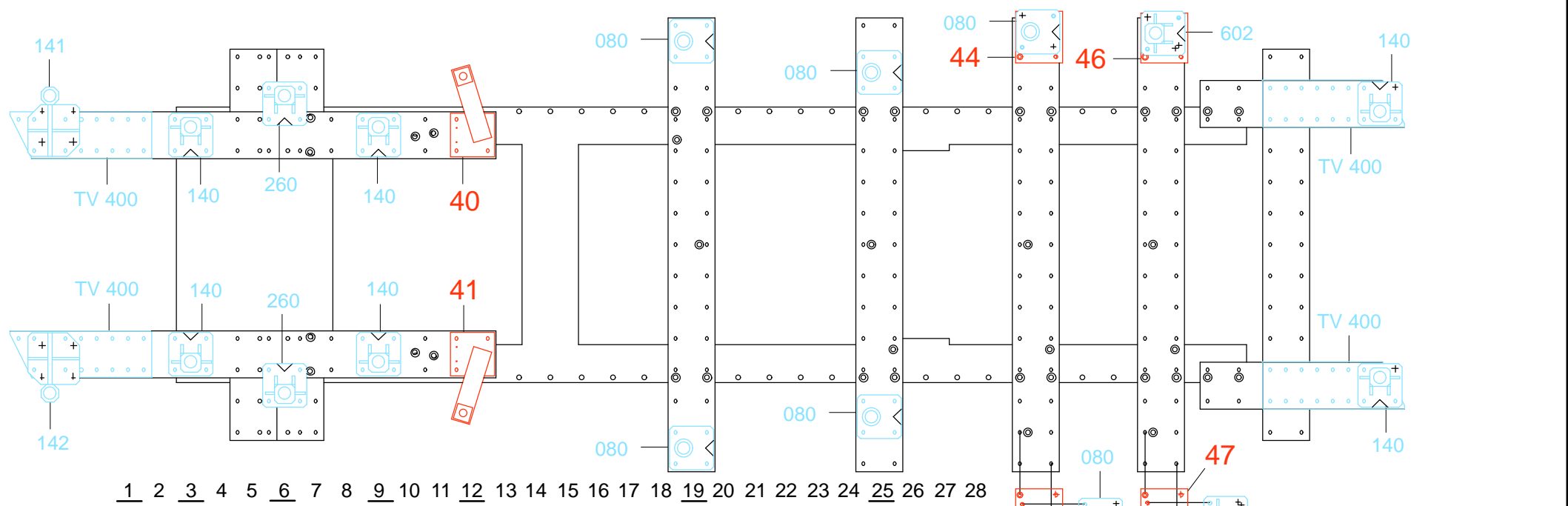

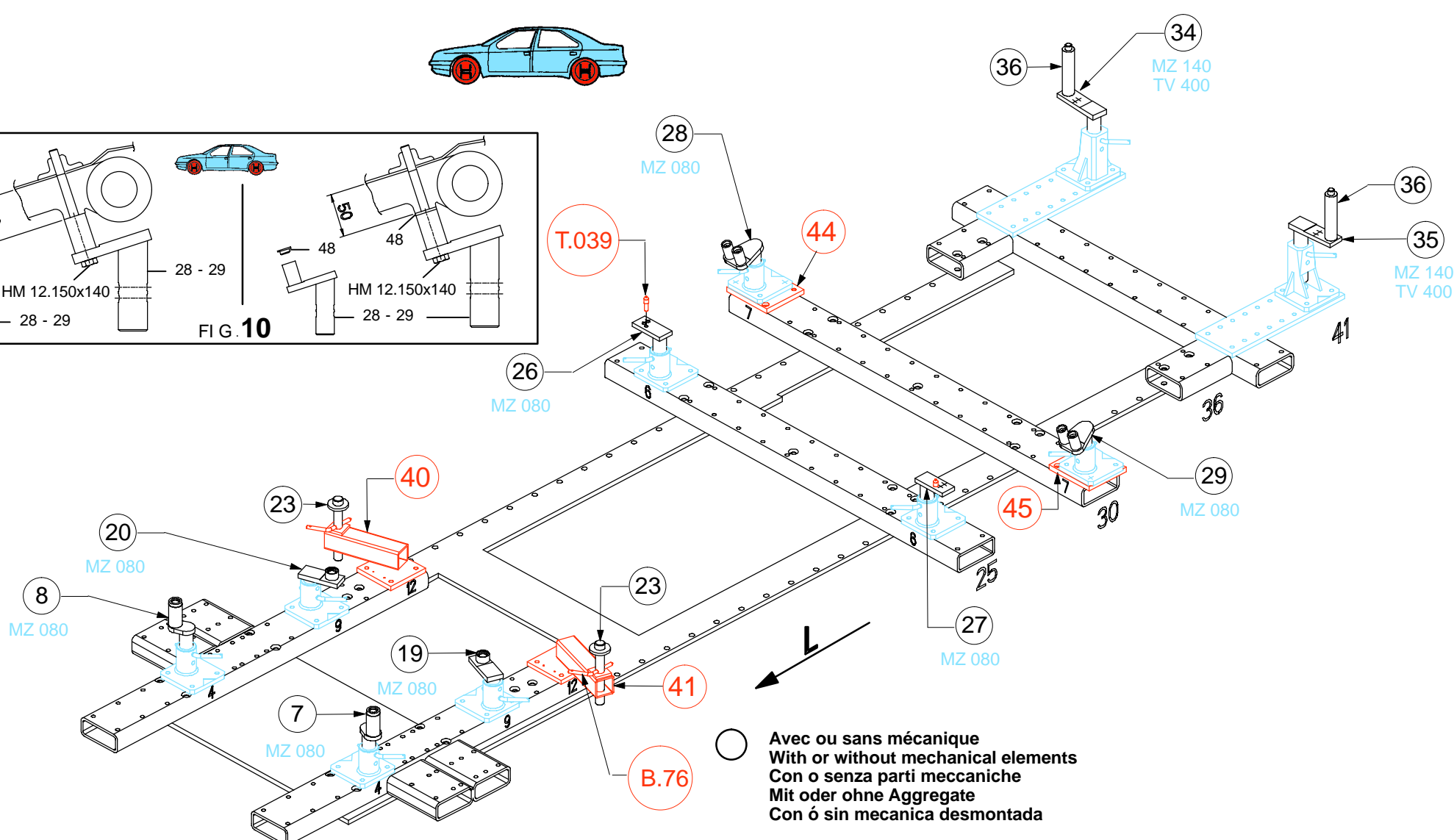
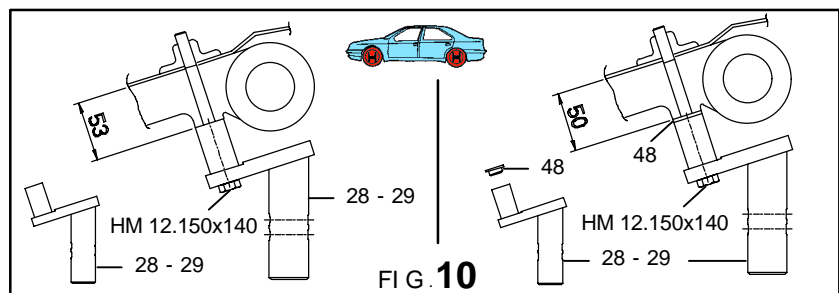
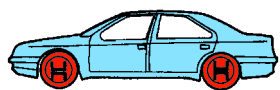

○ Avec ou sans mécanique
 With or without mechanical elements
 Con o senza parti meccaniche
 Mit oder ohne Aggregate
 Con ó sin mecánica desmontada

VAS 5022/1

745.309		
28 Kg	07.05.97	403-D-12B

