

REP.	REFERENCE	PDS	NB	MZ
1	740.7001	1,8	1	140
2	740.7002	1,8	1	140
3	740.7003	1,7	1	200
4	740.7004	1,7	1	200
5	740.7005	2,1	1	260
6	740.7006	2,1	1	260
7	740.7007	2,4	1	200
8	740.7008	2,4	1	200
9	740.7009	2,2	1	080
10	740.7010	2,2	1	080
11	740.7011	2,1	1	140
12	740.7012	2,1	1	140
13	740.7013	3,3	1	080
14	740.7014	3,3	1	080
15	740.7015	1,0	2	
17	740.7017	2,4	1	080
18	740.7018	2,4	1	080
19	740.7019	2,6	1	142/140
20	740.7020	2,6	1	141/140
21	740.7021	1,6	1	260
22	740.7022	1,6	1	260
	E.07	0,1	2	
	B.36	0,3	2	
	B.88	0,3	2	

	M 12x25	2
	M 12x30	4
	M 14x25	2
	M 14.150x40	4

	LLU 12	2
--	--------	---

○ Avec ou sans mécanique
With or without mechanical elements
Con o senza parti meccaniche
Mit oder ohne Aggregate
Con ó sin mecanica desmontada

TOYOTA

740.300

48 Kg	27.08.96	434-D-54A
-------	----------	-----------

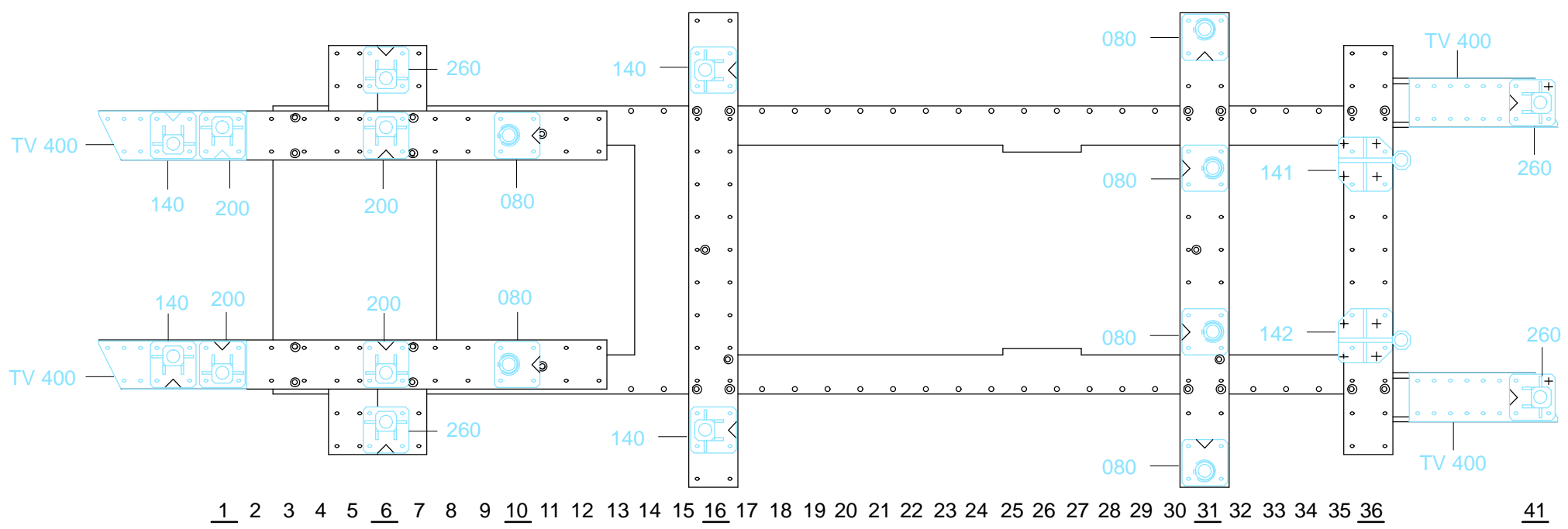

1 2 3 4 5 6 7 8 9 10 11 12 13 14 15 16 17 18 19 20 21 22 23 24 25 26 27 28 29 30 31 32 33 34 35 36 41

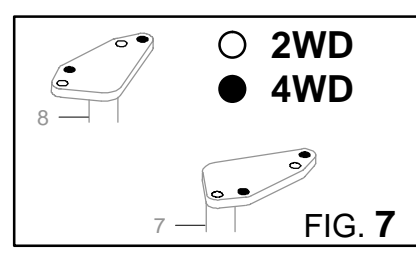
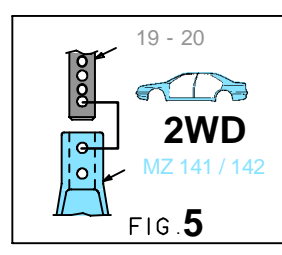
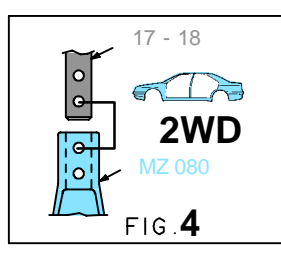
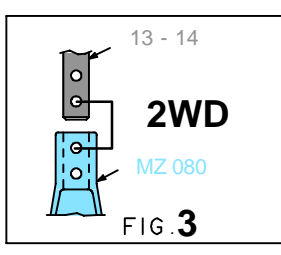
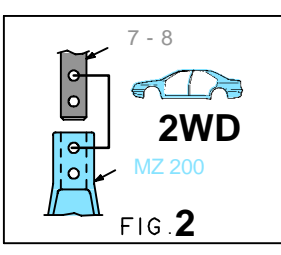
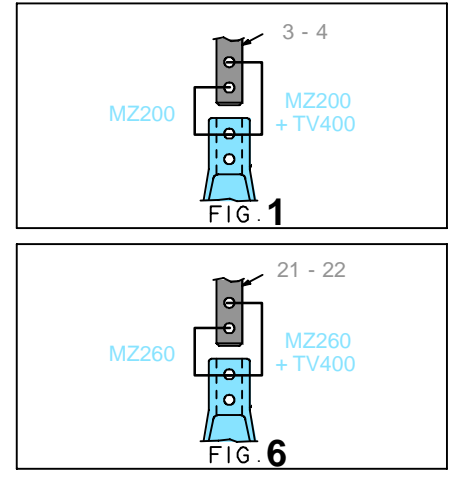

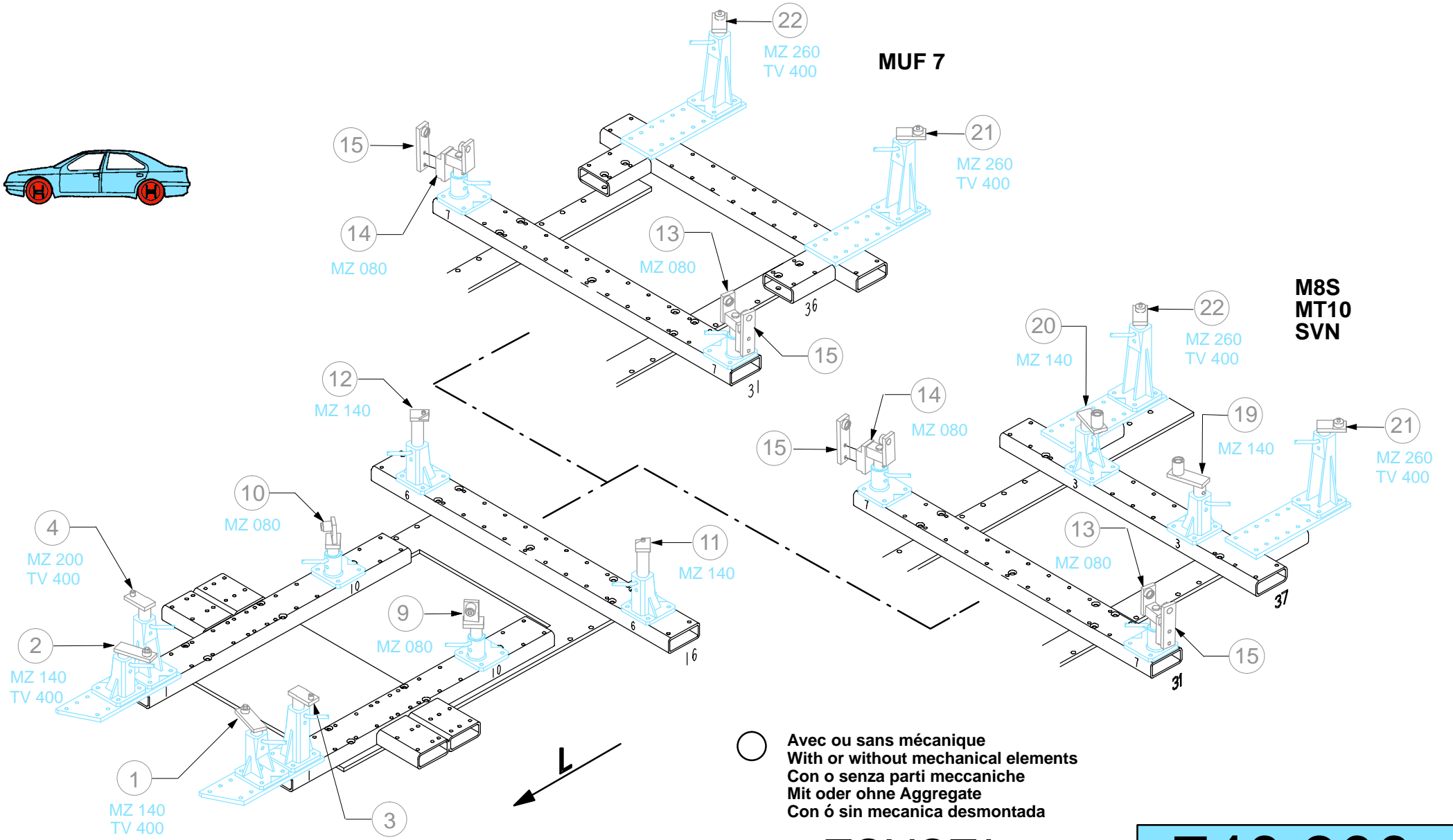

TOYOTA

740.300

48 Kg | 27.08.96 | 434-D-54B

