

○ Avec ou sans mécanique
With or without mechanical elements
Con o senza parti meccaniche
Mit oder ohne Aggregate
Con ó sin mecanica desmontada

REP.	REFERENCE	PDS	NB	MZ
1	726.7001	2,2	1	260
2	726.7002	2,2	1	260
3	726.7003	2,8	1	200
4	726.7004	2,8	1	200
5	726.7005	1,2	1	
6	726.7006	1,2	1	
7	726.7007	1,4	1	080
8	726.7008	1,4	1	080
9	726.7009	0,5	2	
10	726.7010	3,2	1	602
11	726.7011	3,2	1	601
12	726.7012	0,9	2	
13	726.7013	2,0	1	140/080
14	726.7014	2,0	1	140/080
15	726.7015	1,5	1	200
16	726.7016	1,3	1	200
17	726.7017	1,8	1	080
18	726.7018	1,8	1	080
19	726.7019	3,1	1	200
20	726.7020	3,1	1	200
21	726.7021	3,1	1	140
22	726.7022	2,0	1	141
23	726.7023	2,0	1	142
24	726.7024	0,6	2	
	E.12	0,1	2	

	M 12x30	6
	M 12.125x20	2
	M 12.125x60	2
	M 12.125x100	2
	M 12	2

MAZDA

726.300

50 Kg 26.08.96 419-D-25A

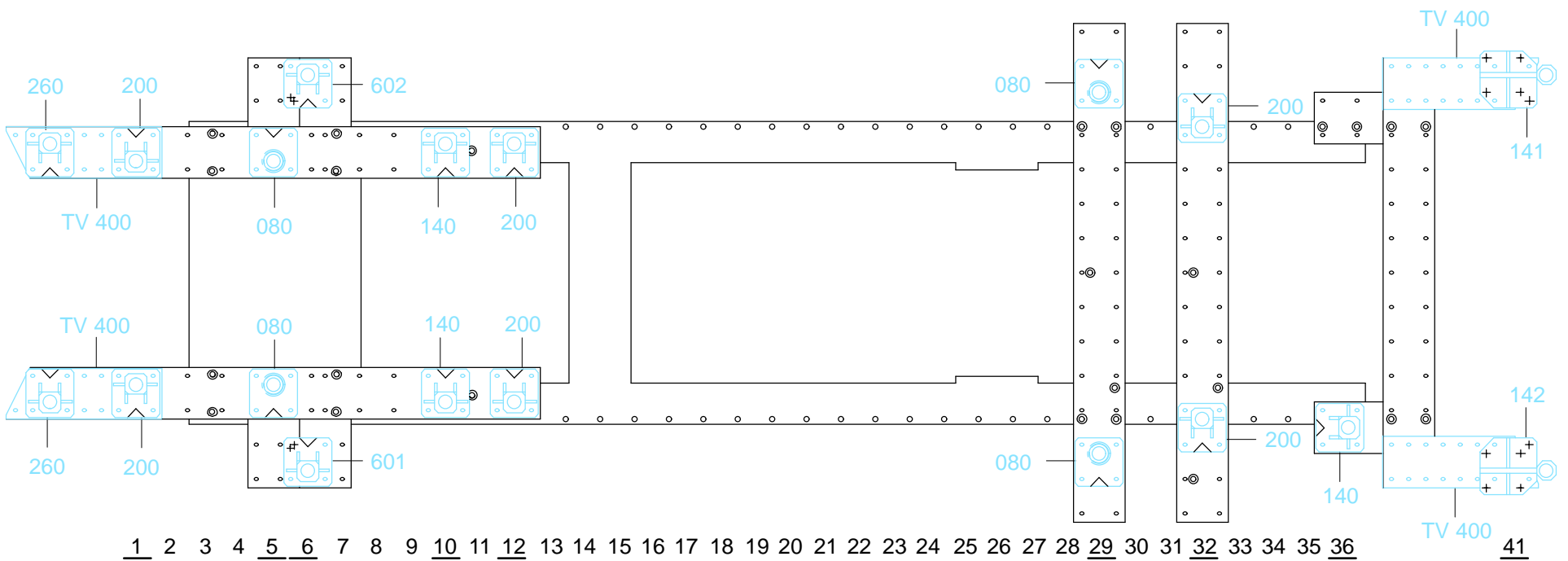

1 2 3 4 5 6 7 8 9 10 11 12 13 14 15 16 17 18 19 20 21 22 23 24 25 26 27 28 29 30 31 32 33 34 35 36

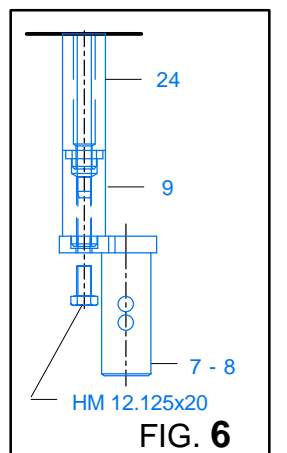
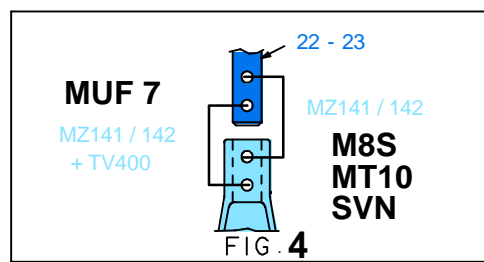
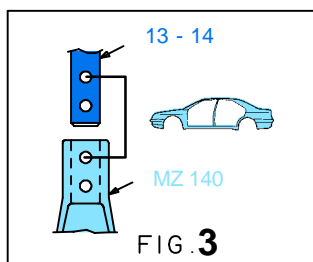
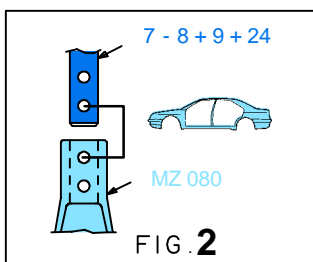
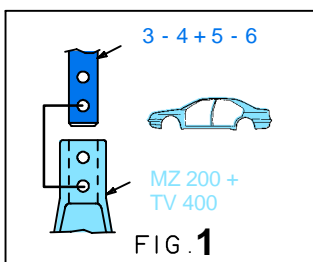
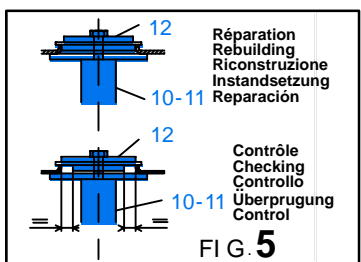

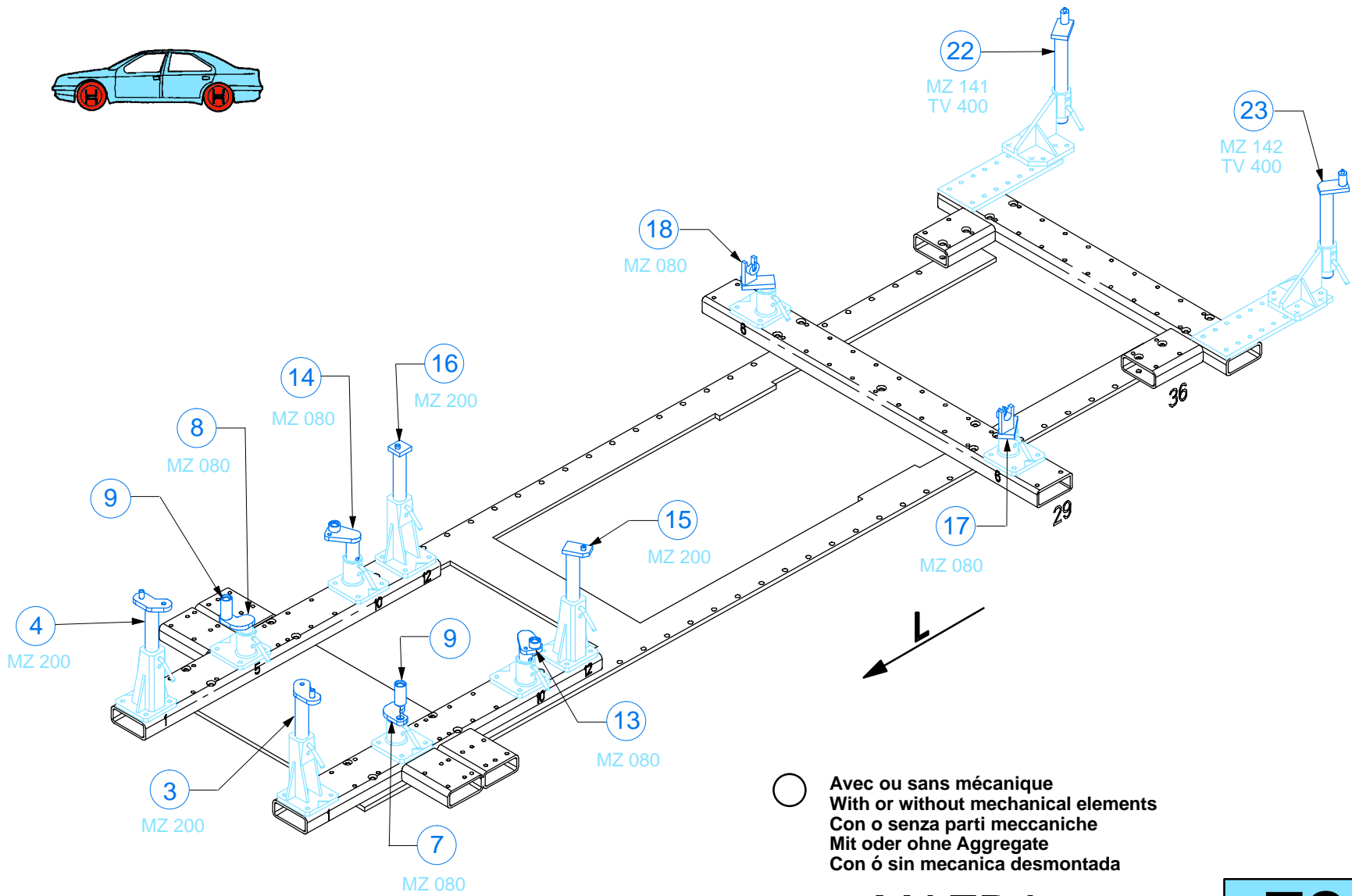

MAZDA

726.300

50 Kg | 26.08.96 | 419-D-25B

