

○ Avec ou sans mécanique
With or without mechanical elements
Con o senza parti meccaniche
Mit oder ohne Aggregate
Con ó sin mecanica desmontada

HONDA / ACURA

REP.	REFERENCE	PDS	NB	MZ
3	722.7003	1,8	1	601
4	722.7004	1,8	1	602
9	722.7009	2,4	1	141
10	722.7010	2,4	1	142
12	722.7012	2,7	1	140/200
13	722.7013	2,7	1	140/200
14	722.7014	2,2	1	602
15	722.7015	2,2	1	601
16	722.7016	1,6	1	260
17	722.7017	1,6	1	260

	M 12x70	4
	M 12.125x90	2
	M 12.125x130	2
	M 12.125x140	2
	M 12.125x220	2

	M 12	4
--	------	---

complément au
complementary set to
complemento al
zusatz zu **702.300**

702.309

23 Kg 14.02.96 413-D-23C

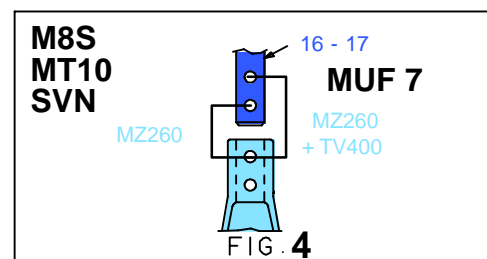
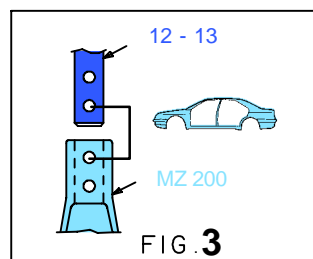
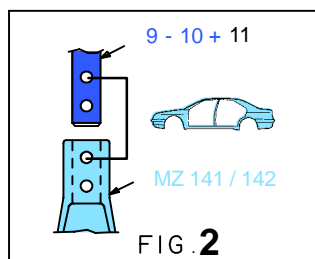
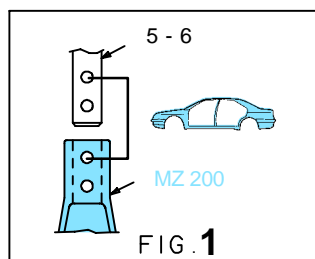
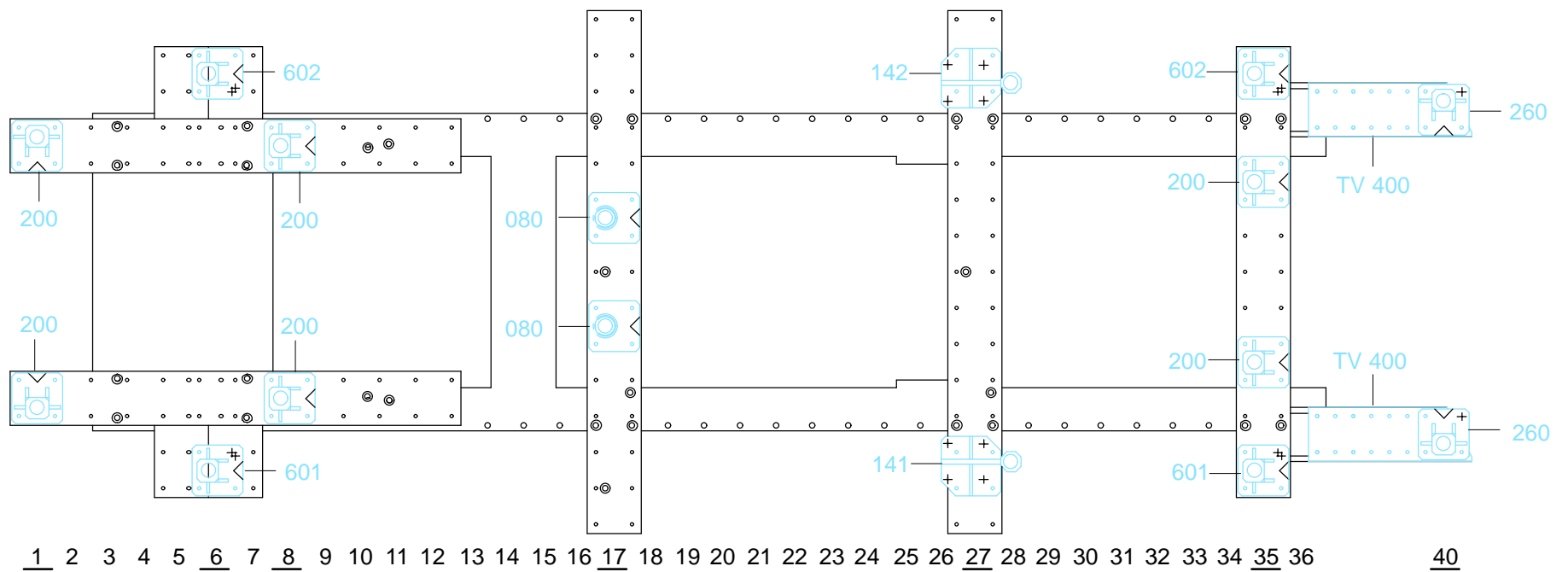

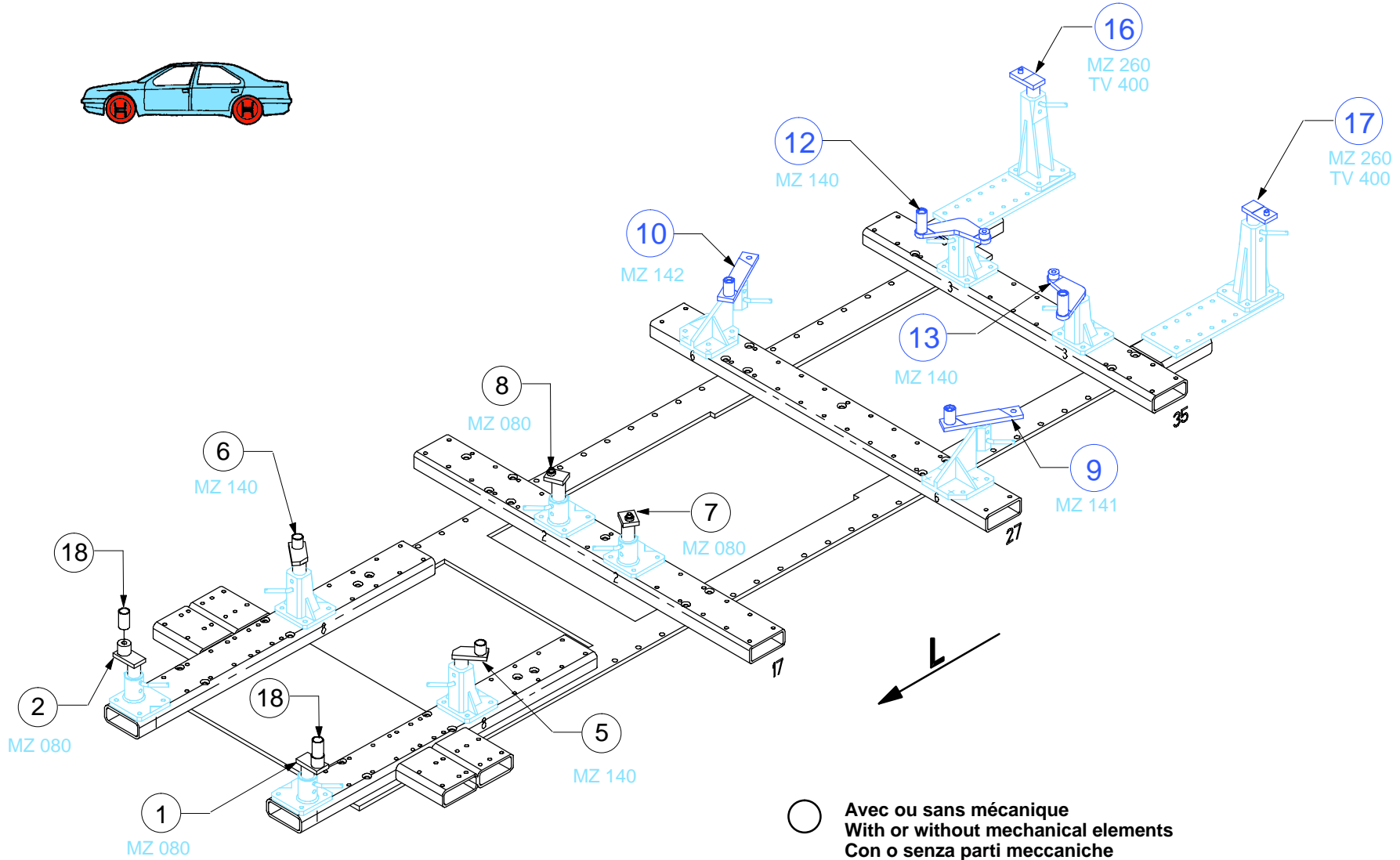
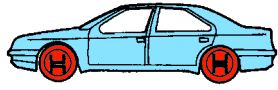

○ Avec ou sans mécanique
With or without mechanical elements
Con o senza parti meccaniche
Mit oder ohne Aggregate
Con ó sin mecanica desmontada

HONDA / ACURA

702.309

23 Kg

19.03.96

413-D-23D

