

REP.	REFERENCE	PDS	NB	MZ
1	688.701	2,1	1	140
2	688.702	0,02	2	
3	688.703	2,8	1	260/080
4	688.704	2,1	1	260/080
5	688.705	0,9	2	
6	688.706	3,7	1	602
7	688.707	3,7	1	601
8	688.708	3,4	1	200
9	688.709	3,4	1	200
10	688.710	0,1	2	
11	688.711	2,4	1	080
12	688.712	2,4	1	080
13	688.713	1,5	2	
14	688.714	1,7	1	080
15	688.715	1,7	1	080
16	688.716	2,2	1	140
17	688.717	2,2	1	140
18	688.718	1,0	2	
19	688.719	3,2	1	200
20	688.720	3,2	1	200
21	688.721	3,5	1	260
22	688.722	3,5	1	260
23	688.723	0,6	2	
24	688.724	3,2	1	142
25	688.725	3,2	1	141
	E.19	0,1	2	
	D.088	0,6	2	
	V.09	0,1	2	

	M 10.125x40	4
	M 12.125x20	2
	M 12.125x70	2
	M 12.125x80	2
	M 12.125x90	2
	M 12x25	4
	M 12x30	2
M 12x40	2	
	M 12	2

○ Avec ou sans mécanique  
With or without mechanical elements  
Con o senza parti meccaniche  
Mit oder ohne Aggregate  
Con ó sin mecanica desmontada

## KIA

# 688.300

64 Kg    20.05.94    448-D-1A

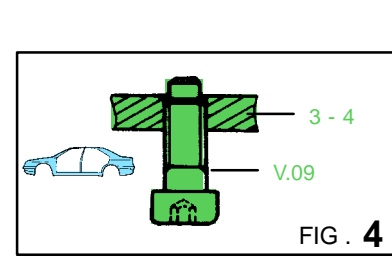
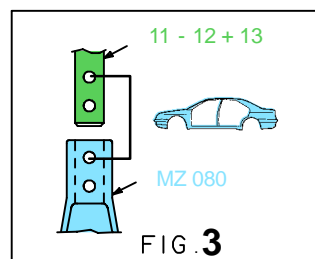
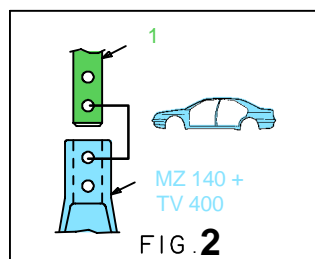
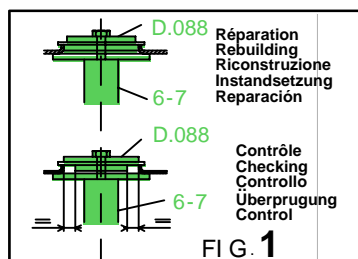
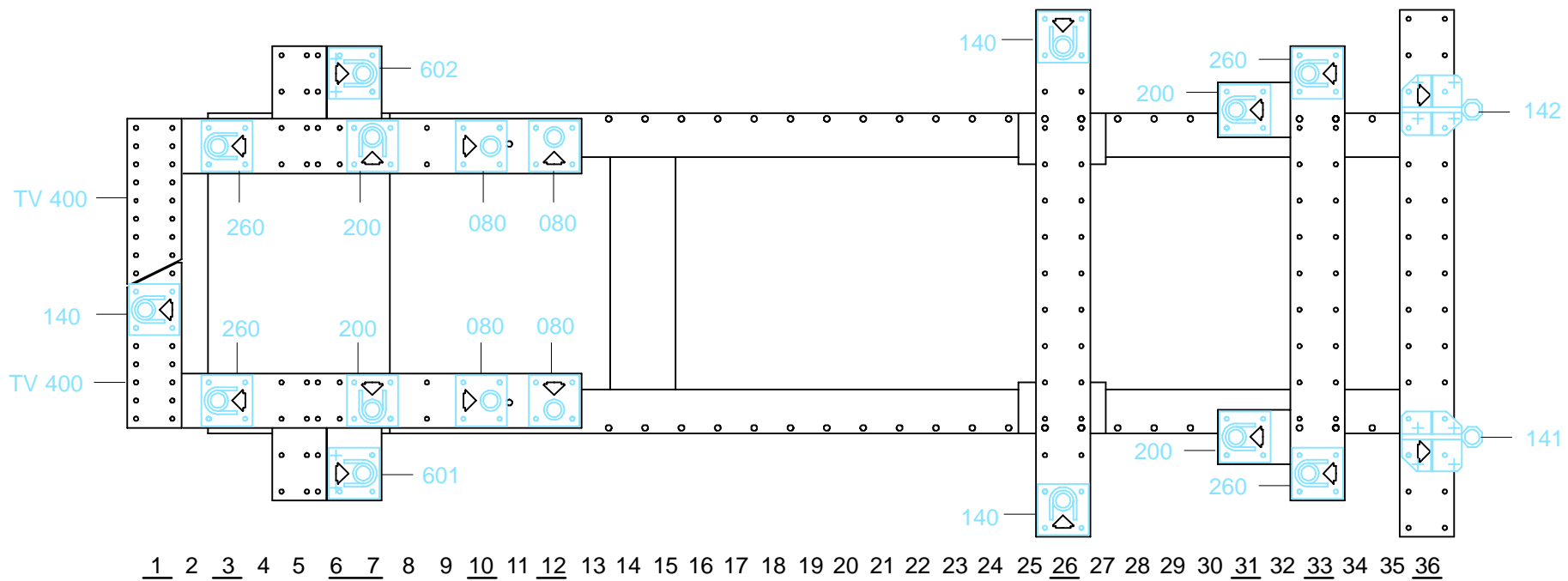

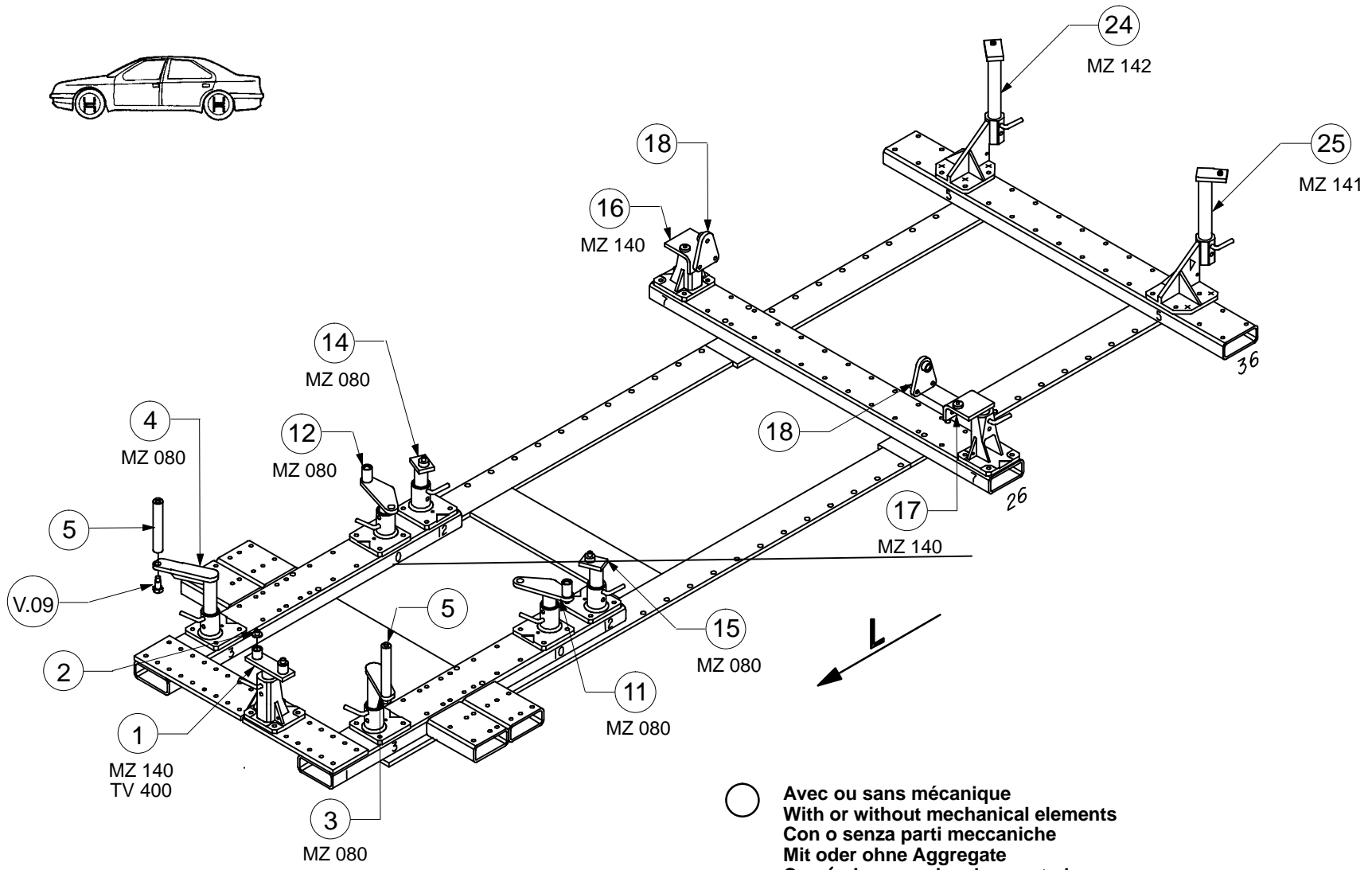
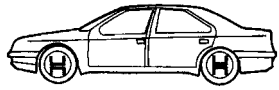

**KIA**

**688.300**

64 Kg    20.05.94    448-D-1B

