

REP.	REFERENCE	PDS	NB	MZ
27	686.727	3,3	1	601
28	686.728	3,3	1	602
29	686.729	3,1	1	
30	686.730	3,1	1	
31	686.731	2,6	1	200
	D.061	0,5	2	

M 12x30 6

complément au
complementary set to
complemento al
zusatz zu **686.300**

686.309

17 Kg 26.10.94 410-D-53C

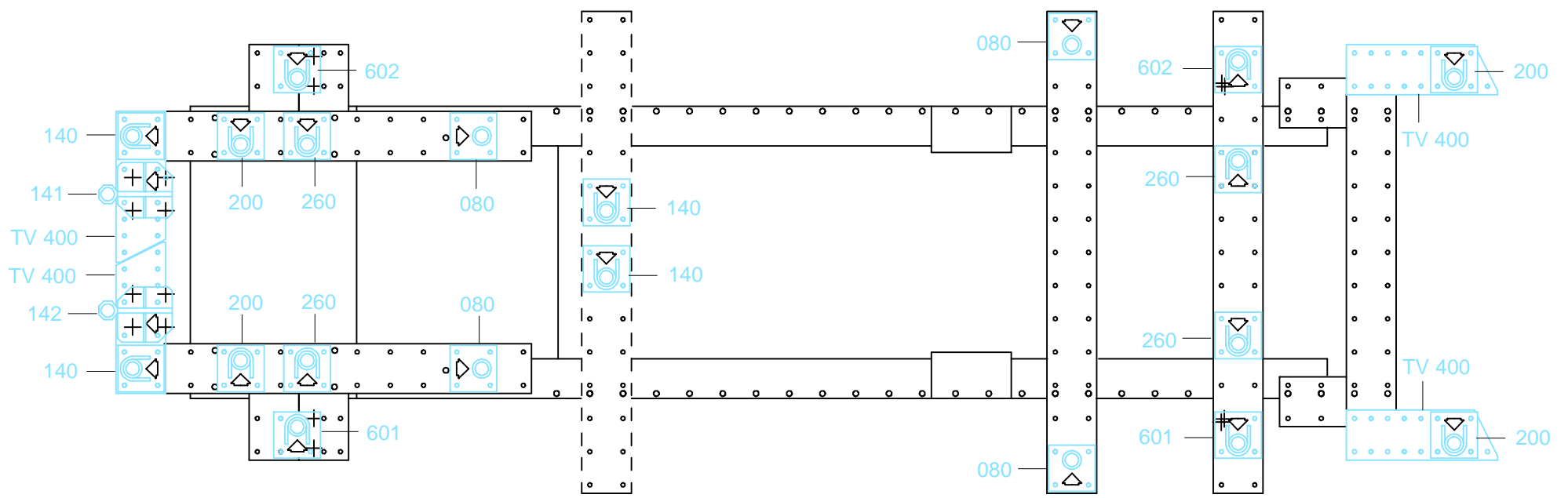

1 2 3 4 5 6 7 8 9 10 11 12 13 14 15 16 17 18 19 20 21 22 23 24 25 26 27 28 29 30 31 32 33 34 35 36

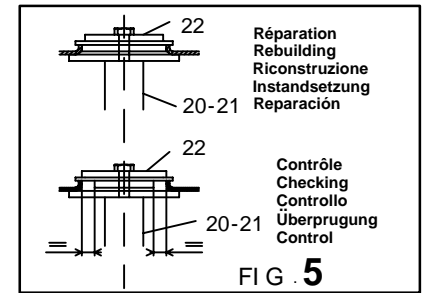
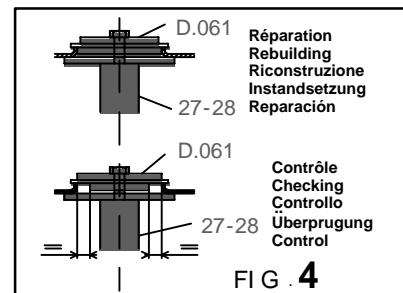
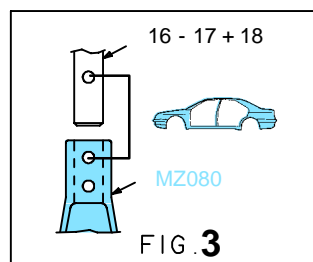
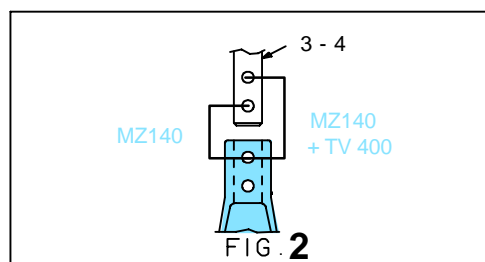
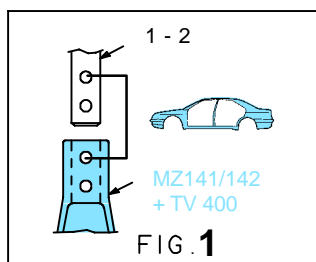

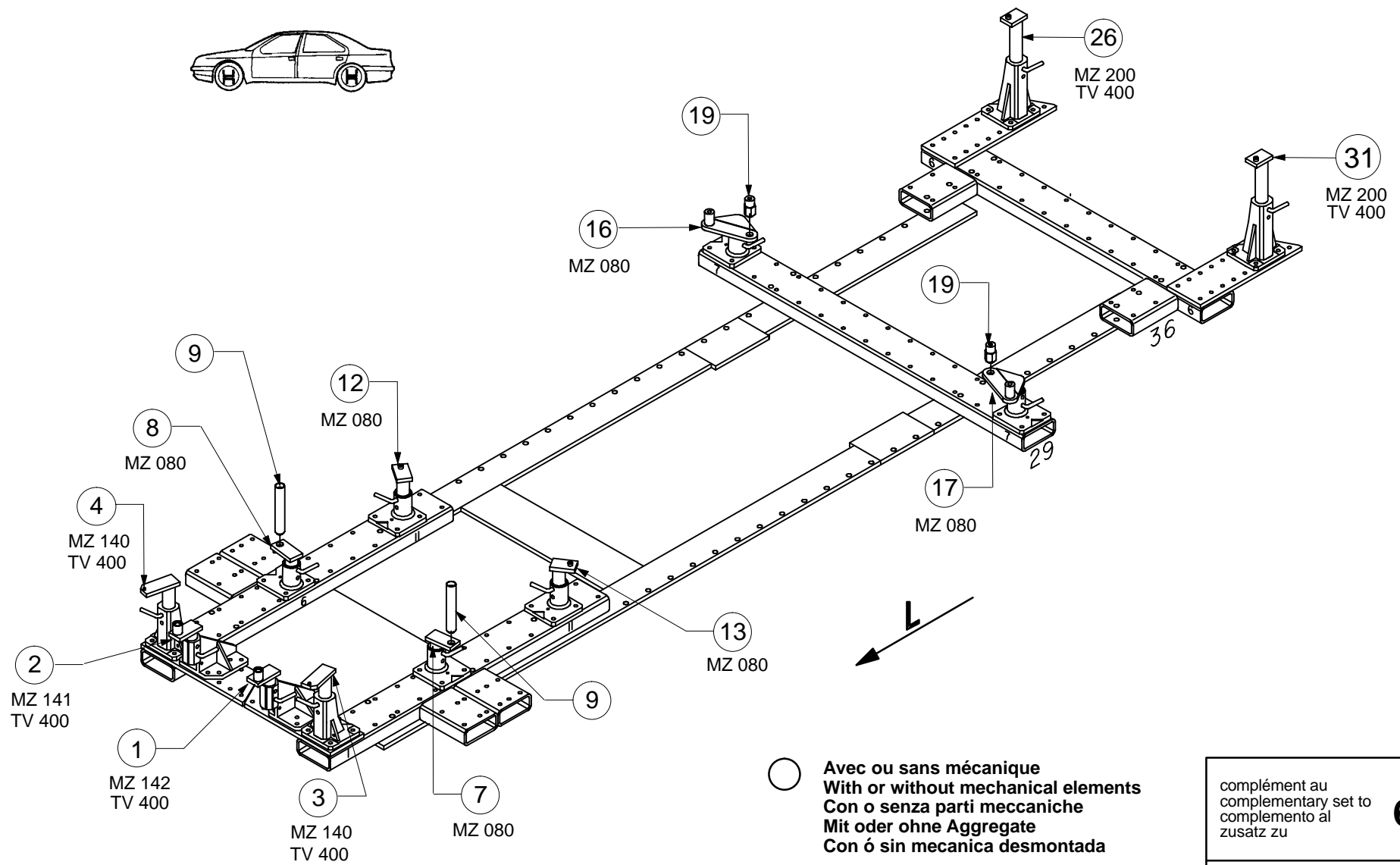
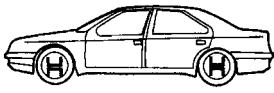

○ Avec ou sans mécanique
 With or without mechanical elements
 Con o senza parti meccaniche
 Mit oder ohne Aggregate
 Con ó sin mecanica desmontada

complément au
 complementary set to
 complemento al
 Zusatz zu **686.300**

NISSAN

686.309

17 Kg | 26.10.94 | 410-D-53D

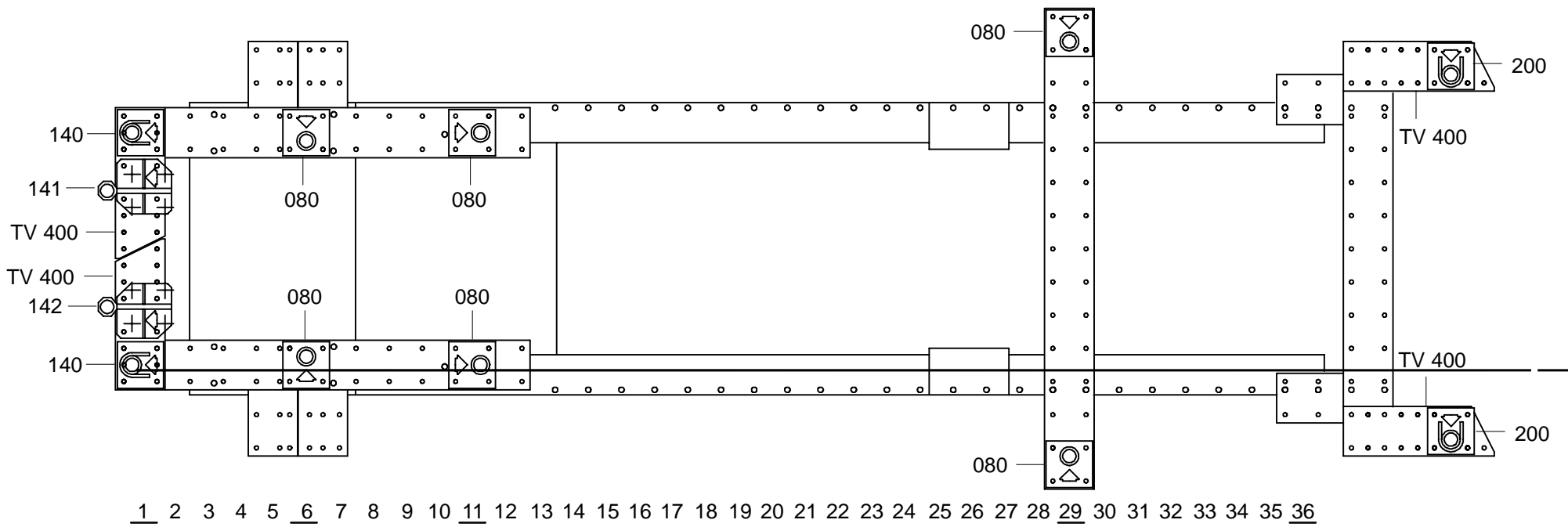

1 2 3 4 5 6 7 8 9 10 11 12 13 14 15 16 17 18 19 20 21 22 23 24 25 26 27 28 29 30 31 32 33 34 35 36

