

REP.	REFERENCE	PDS	NB	MZ
1	667.701	1,6	2	200
2	667.702	1,7	1	
3	667.703	1,7	1	
4	667.704	3,9	1	142
5	667.705	3,9	1	141
6	667.706	0,8	2	
7	667.707	1,5	2	080
8	667.708	2,0	2	140
9	667.709	2,9	1	601
10	667.710	2,9	1	602
11	667.711	0,4	2	
12	667.712	1,5	1	080
13	667.713	1,5	1	080
14	667.714	0,4	2	
15	667.715	1,4	1	080
16	667.716	1,4	1	080
17	667.717	3,9	1	
18	667.718	3,9	1	
19	667.719	0,8	2	
20	667.720	2,5	1	080
21	667.721	2,5	1	080
22	667.722	2,2	1	080
23	667.723	2,2	1	080
24	667.724	0,8	2	
25	667.725	2,8	1	601
26	667.726	2,8	1	602
27	667.727	0,4	2	
28	667.728	1,4	1	200
29	667.729	1,6	1	200
30	667.730	0,1	2	
	E.13	0,05	2	
	B.50	0,1	2	
	B.05	0,05	2	

M 8x40	4
M 10x30	4
M 10x50	2
M 12x20	2
M 12x25	4
M 12x30	6
M 12.150x90	2
M 12.150x100	2

○ Avec ou sans mécanique
 With or without mechanical elements
 Con o senza parti meccaniche
 Mit oder ohne Aggregate
 Con ó sin mecanica desmontada

SEAT

667.300

68 Kg 04.01.93 431-D-4A

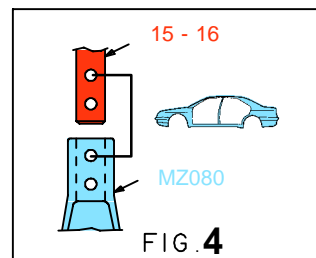
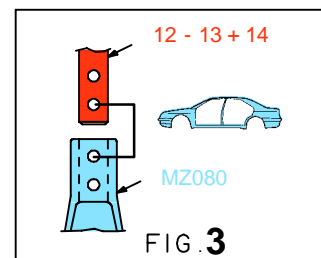
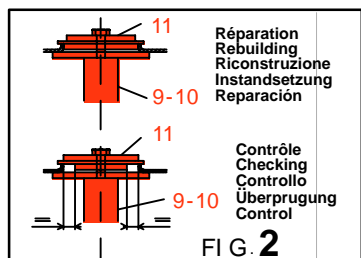
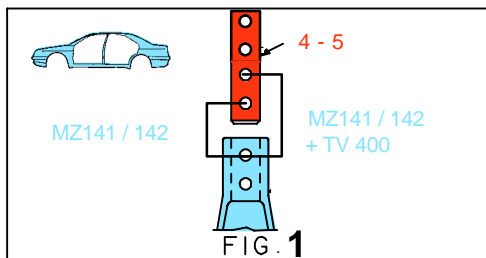
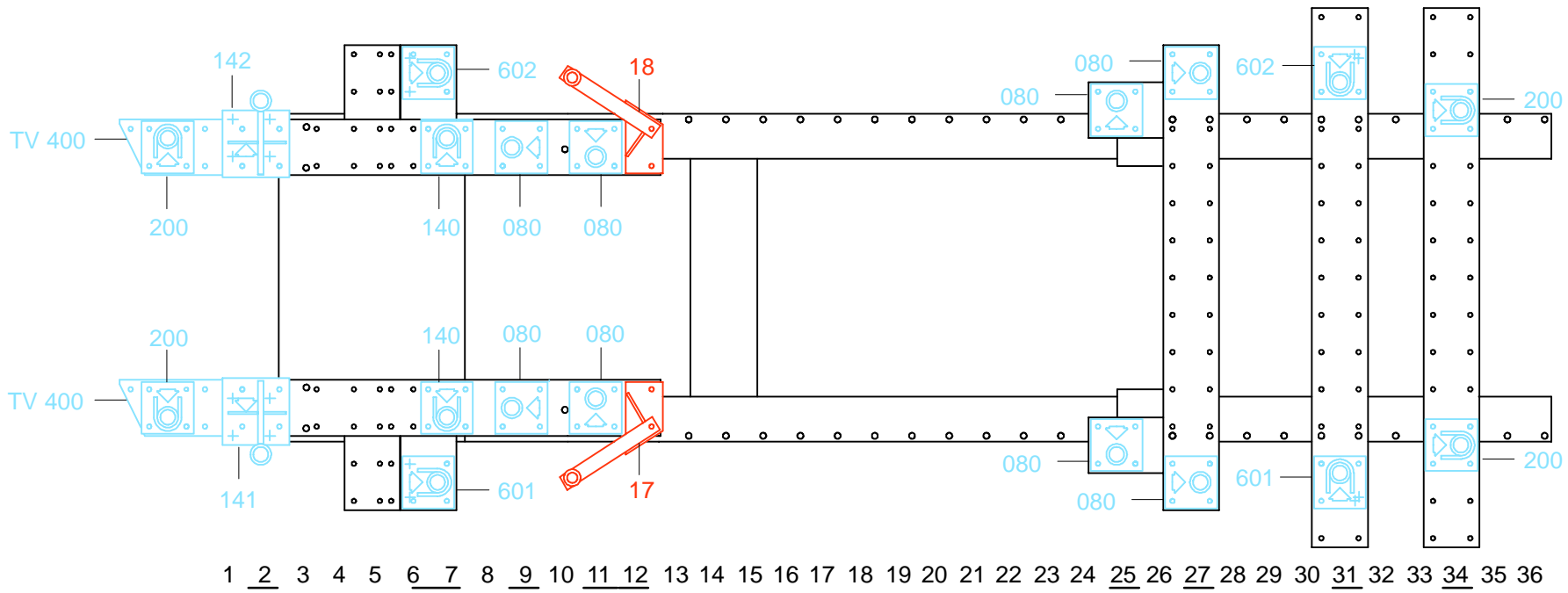

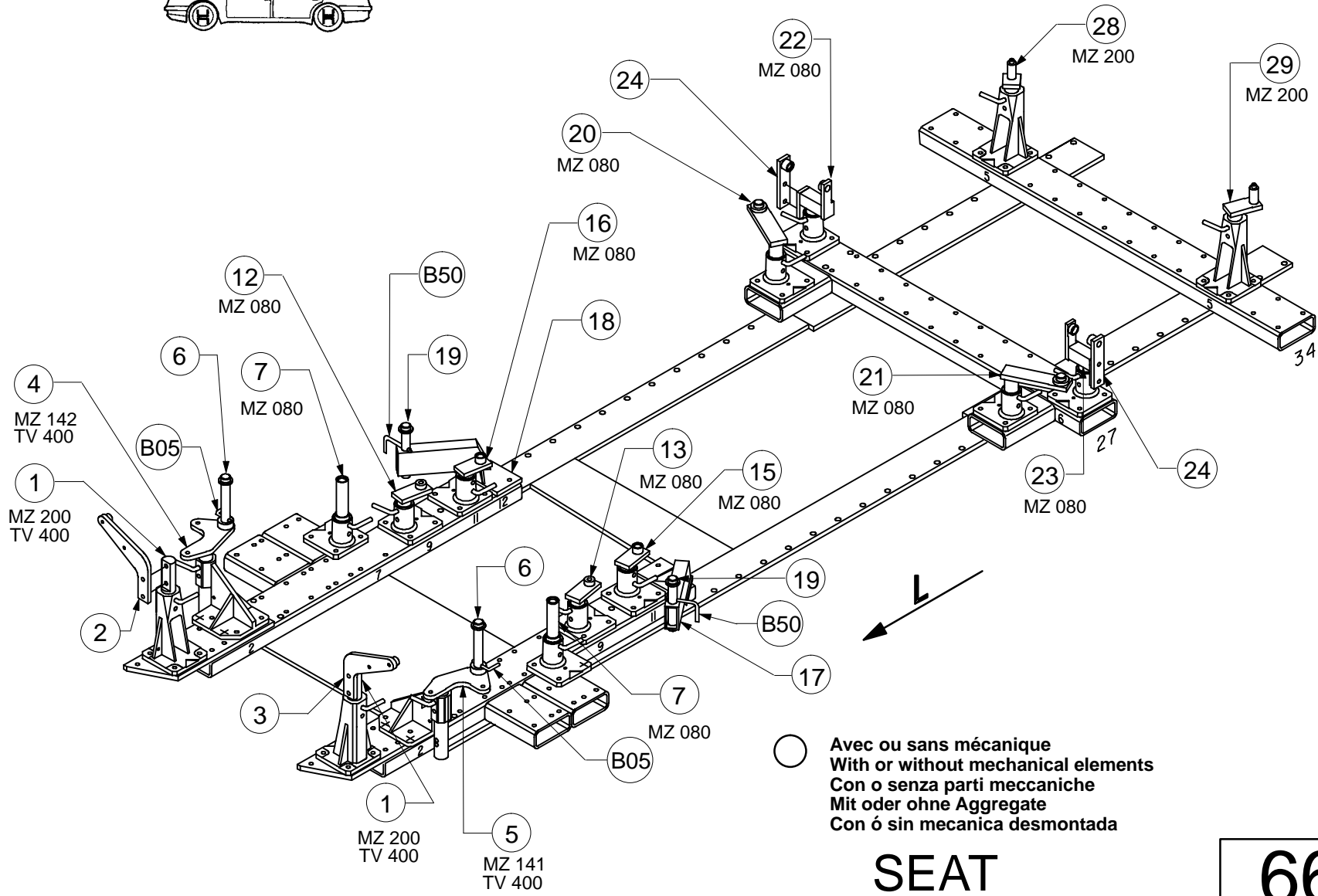
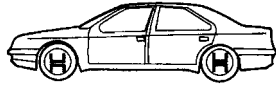

SEAT

667.300

68 Kg 04.01.93 431-D-4B

