

○ Avec ou sans mécanique
With or without mechanical elements
Con o senza parti meccaniche
Mit oder ohne Aggregate
Con ó sin mecanica desmontada

REP.	REFERENCE	PDS	NB	MZ
21	647.721	2,5	1	142
22	647.722	2,5	1	141
23	647.723	2,3	1	260
24	647.724	2,3	1	260
25	647.725	6,8	1	260
26	647.726	6,8	1	260
27	647.727	2,5	1	080
28	647.728	2,5	1	080
29	647.729	2,4	1	080
30	647.730	2,4	1	080

complément au
complementary set to
complemento al
zusatz zu **647.300**

647.309

33 Kg 17.06.97 413-D-20C

HONDA

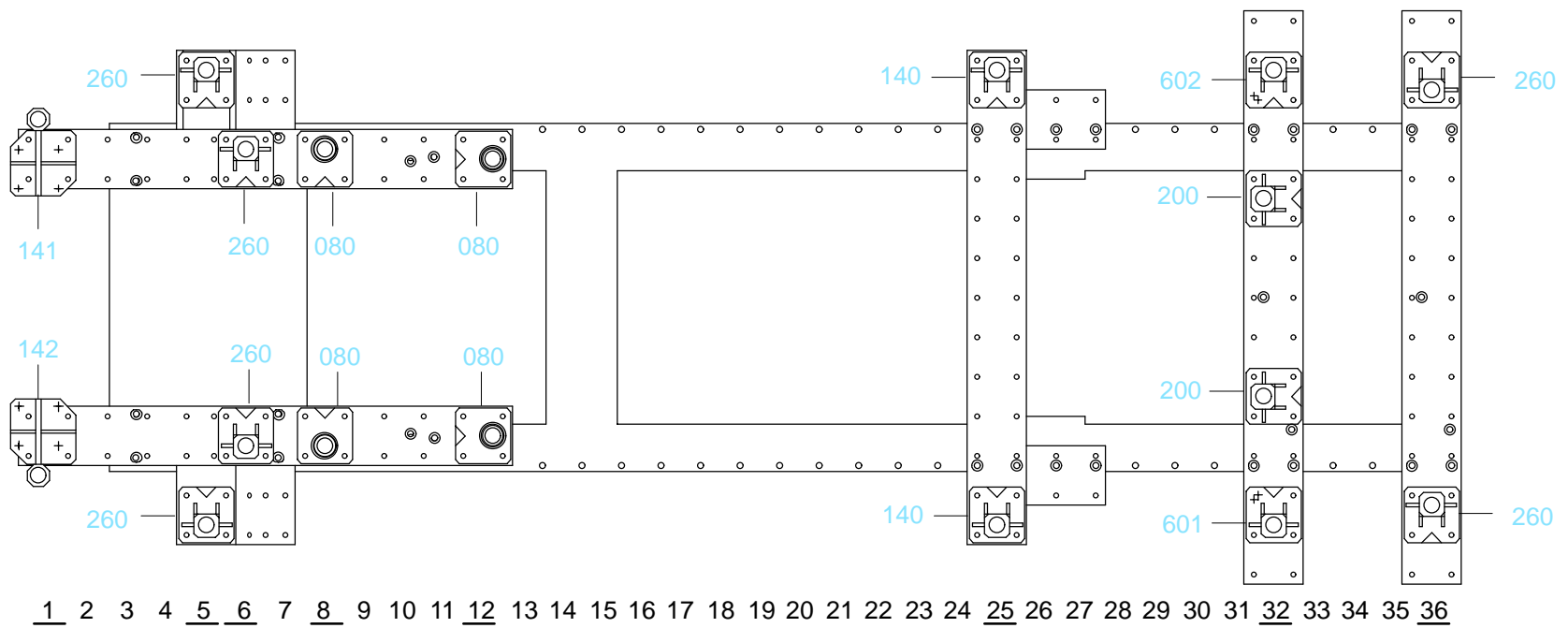

1 2 3 4 5 6 7 8 9 10 11 12 13 14 15 16 17 18 19 20 21 22 23 24 25 26 27 28 29 30 31 32 33 34 35 36

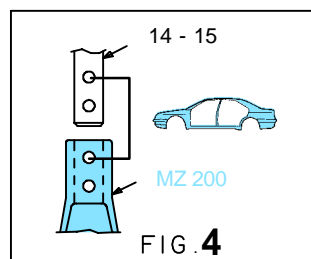
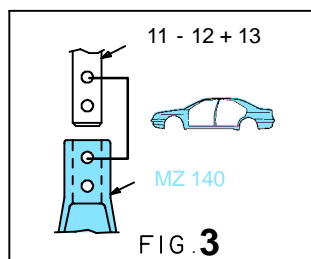
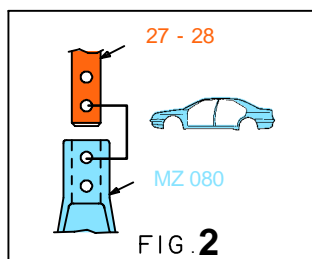
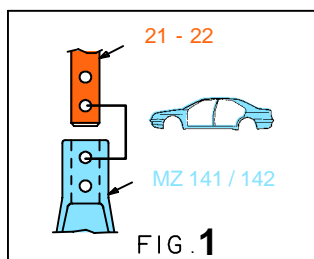

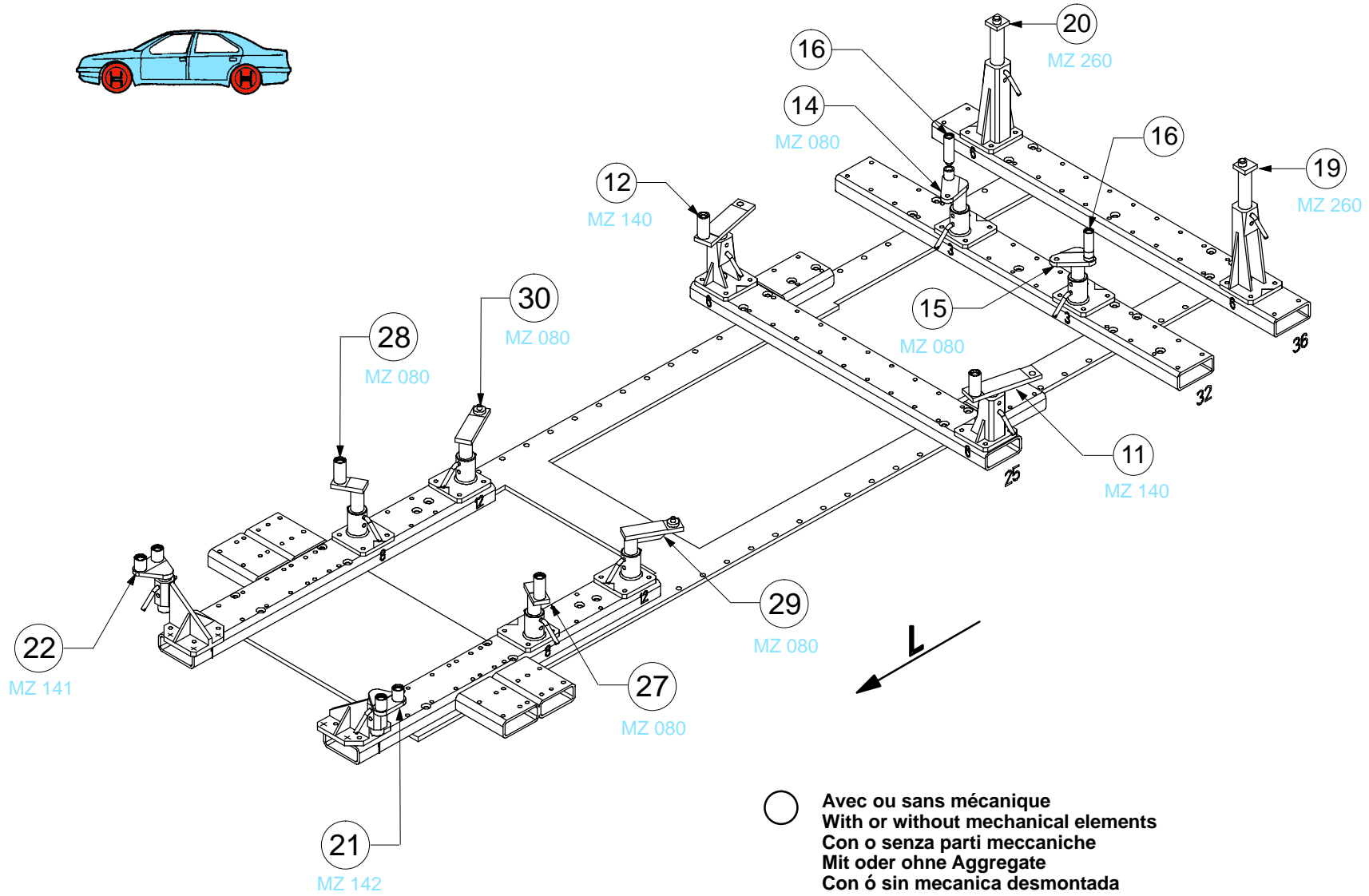
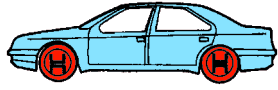

○ Avec ou sans mécanique
With or without mechanical elements
Con o senza parti meccaniche
Mit oder ohne Aggregate
Con ó sin mecanica desmontada

HONDA

647.309

33 Kg | 17.06.97 | 413-D-20D

