

○ Avec ou sans mécanique  
 With or without mechanical elements  
 Con o senza parti meccaniche  
 Mit oder ohne Aggregate  
 Con ó sin mecanica desmontada

REP.	REFERENCE	PDS	NB	MZ
36	605.736	2,6	1	142
37	605.737	2,6	1	141
38	605.738	3,3	1	260
39	605.739	1,2	1	
40	605.740	1,2	1	
41	605.741	2,7	1	200
42	605.742	2,7	1	200
43	605.743	1,7	1	
44	605.744	1,7	1	

	M 8-25	2
	M 12-25	2
	M 14-25	2
	M 12x1,50-60	2
	M 12x1,50-100	2

	M 10	2
--	------	---

complément au  
 complementary set to  
 complemento al  
 zusatz zu **605.340**

**605.305**

20 Kg 23.12.99 423-D-19A

**PEUGEOT**

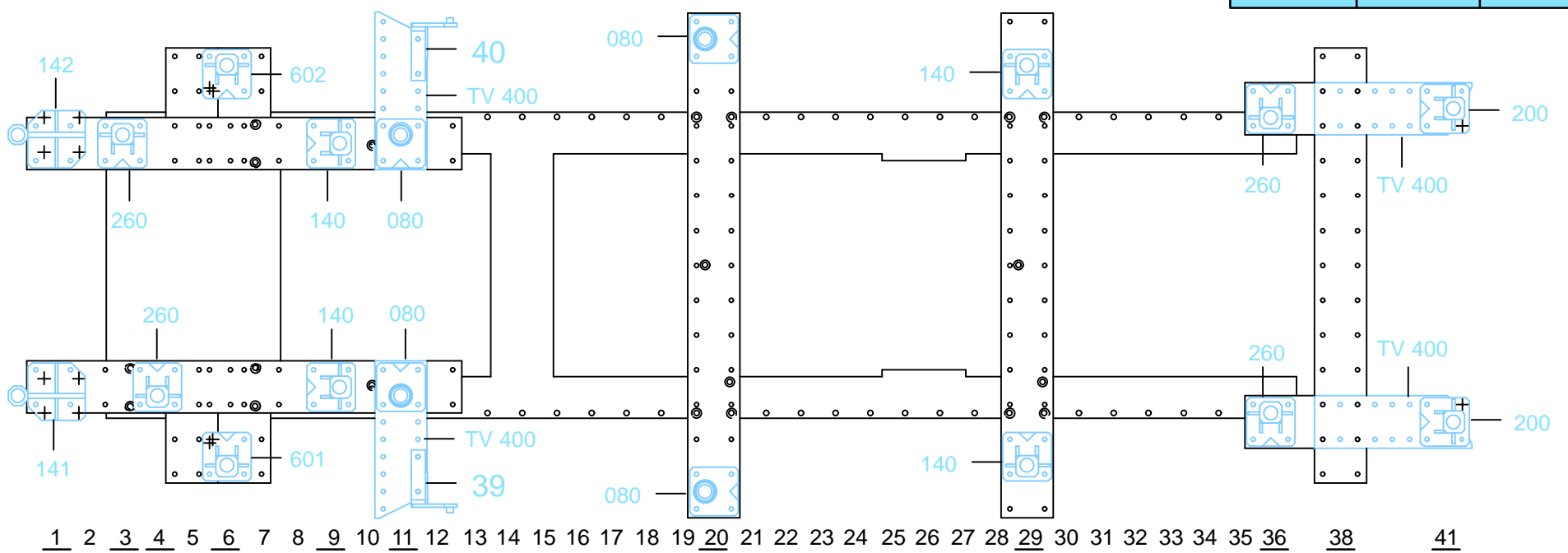

1 2 3 4 5 6 7 8 9 10 11 12 13 14 15 16 17 18 19 20 21 22 23 24 25 26 27 28 29 30 31 32 33 34 35 36 38 41

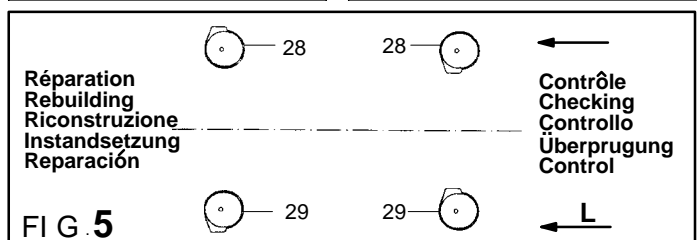
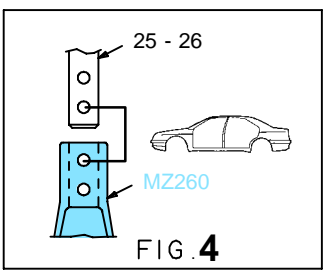
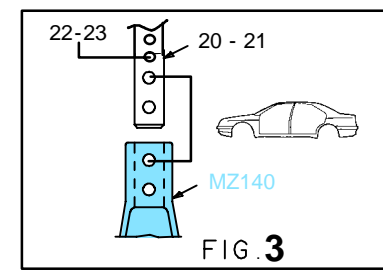
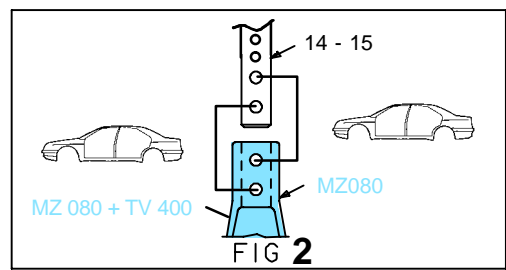
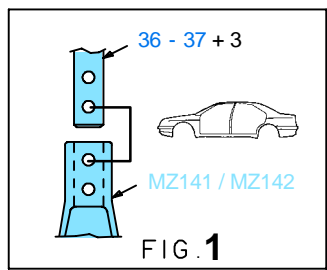

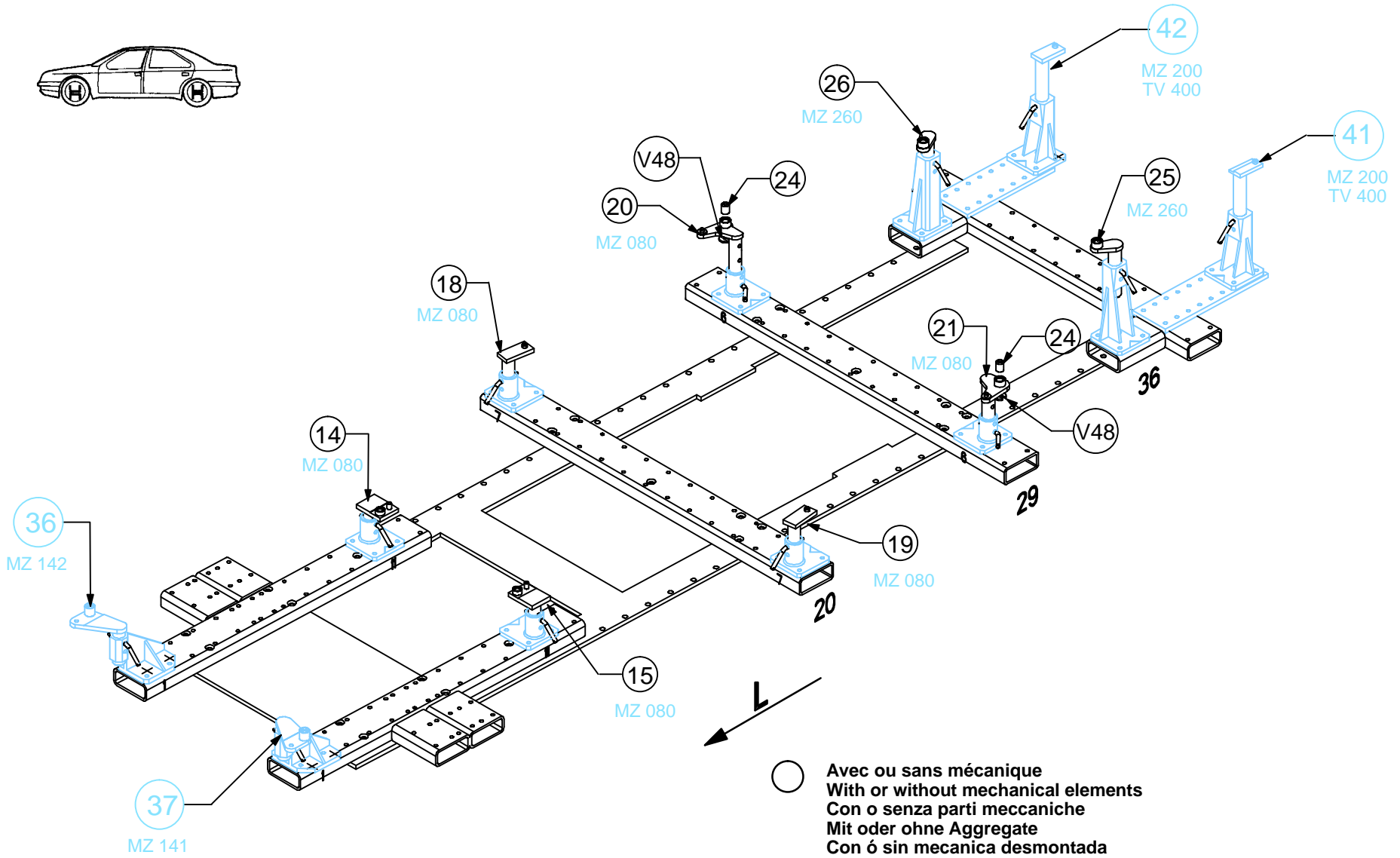
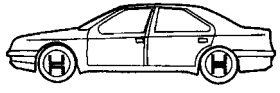

○ Avec ou sans mécanique  
 With or without mechanical elements  
 Con o senza parti meccaniche  
 Mit oder ohne Aggregate  
 Con ó sin mecánica desmontada

**PEUGEOT**

**605.305**

20 Kg    23.12.99    423-D-19B

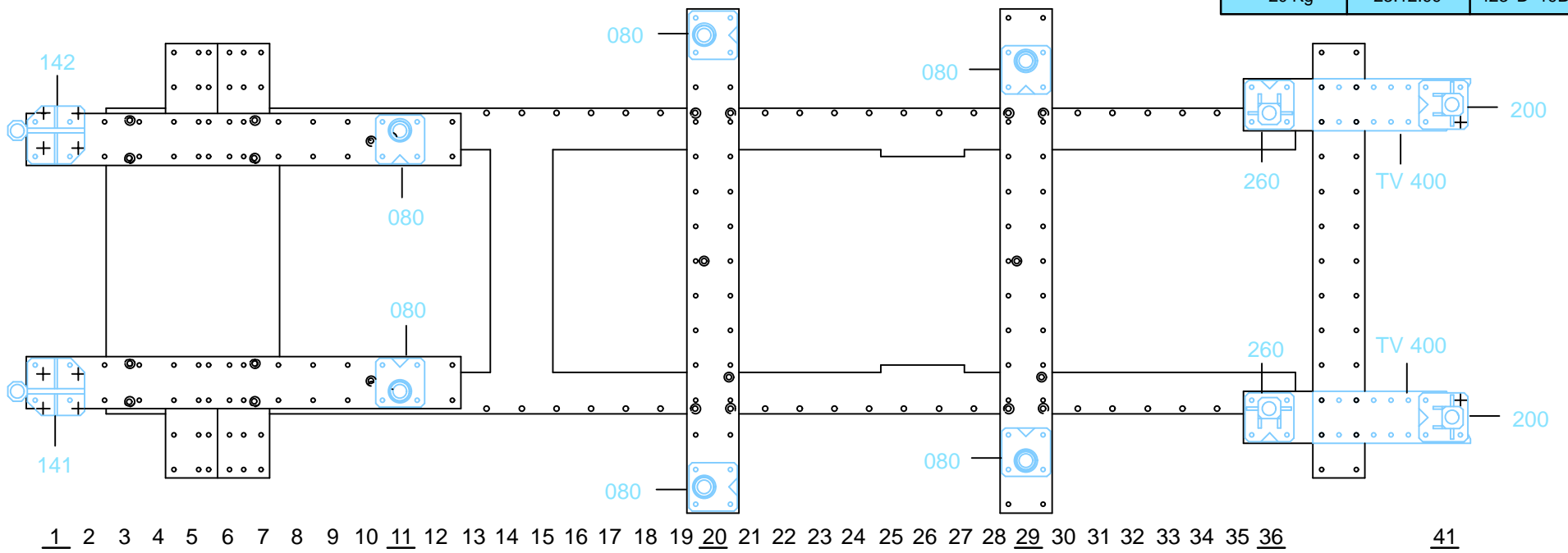

1 2 3 4 5 6 7 8 9 10 11 12 13 14 15 16 17 18 19 20 21 22 23 24 25 26 27 28 29 30 31 32 33 34 35 36 41

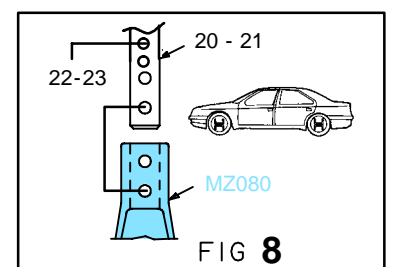
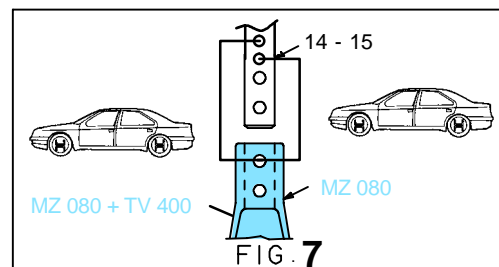
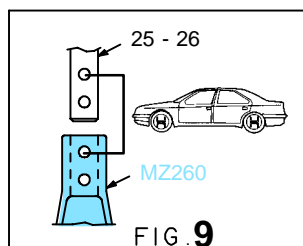
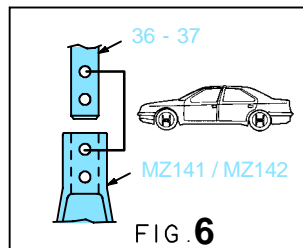
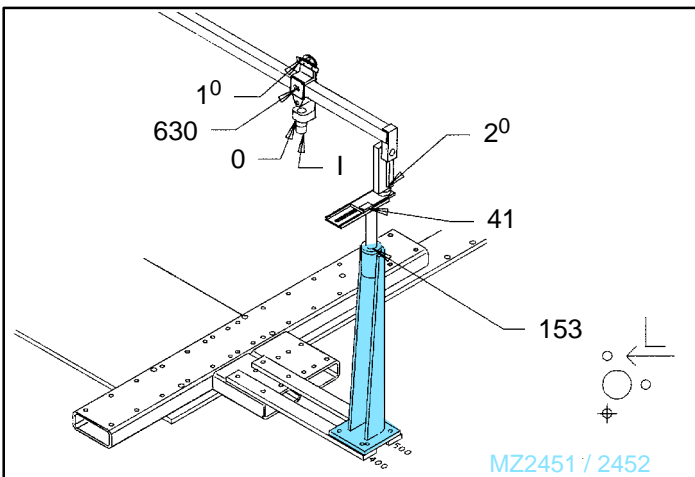

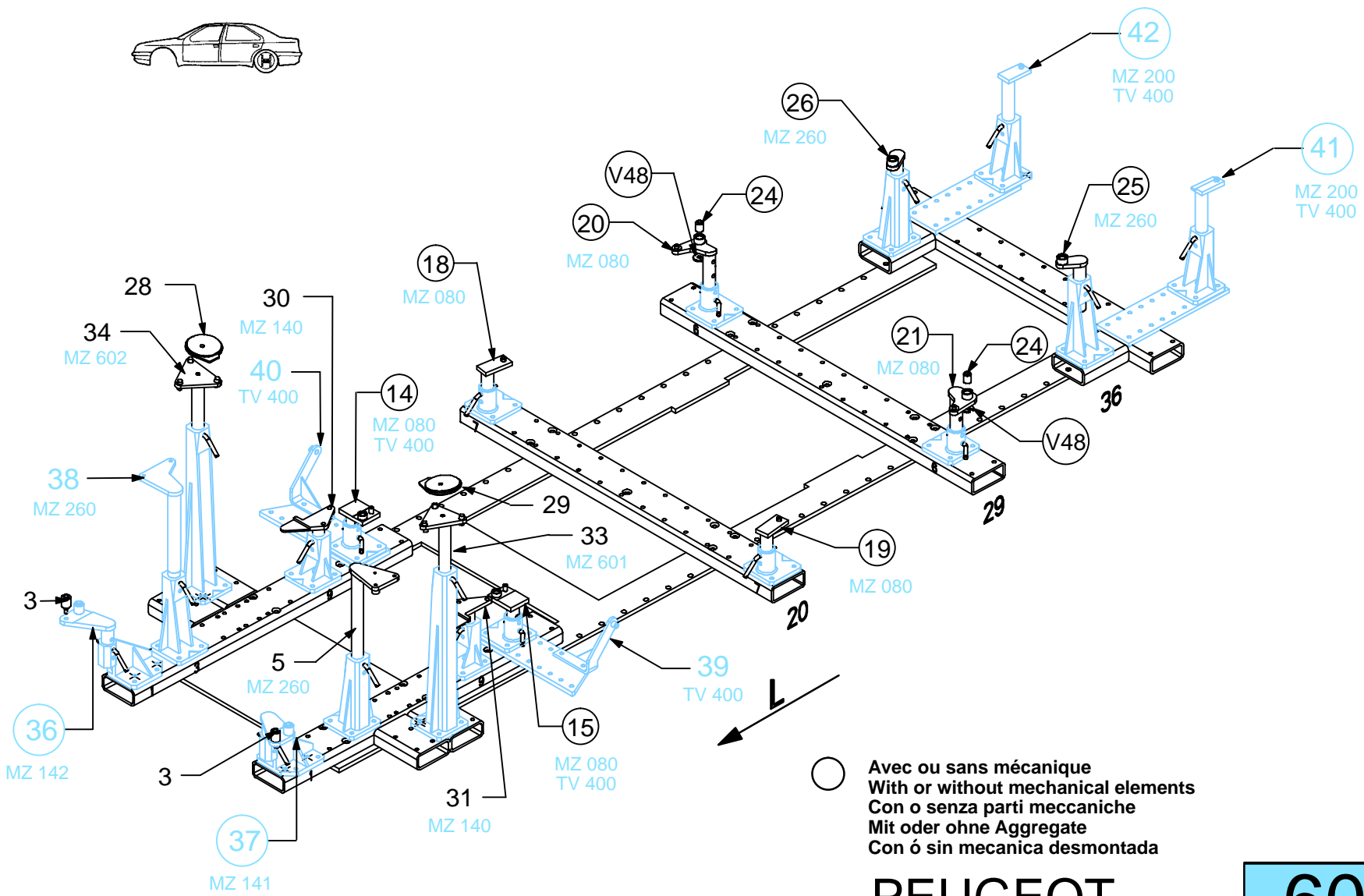
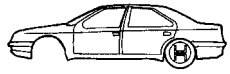

○ Avec ou sans mécanique  
 With or without mechanical elements  
 Con o senza parti meccaniche  
 Mit oder ohne Aggregate  
 Con ó sin mecanica desmontada

**PEUGEOT**

**605.305**

20 Kg    23.12.99    423-D-19C

