

ANCRAGE DU VEHICULE
ANCHORING OF THE VEHICLE
VERANKERUNG DES FAHRZEUGS
ANCORAGGIO DEL VEICOLO
ANCLAJE DEL VEHICULO } **AN.27.B**

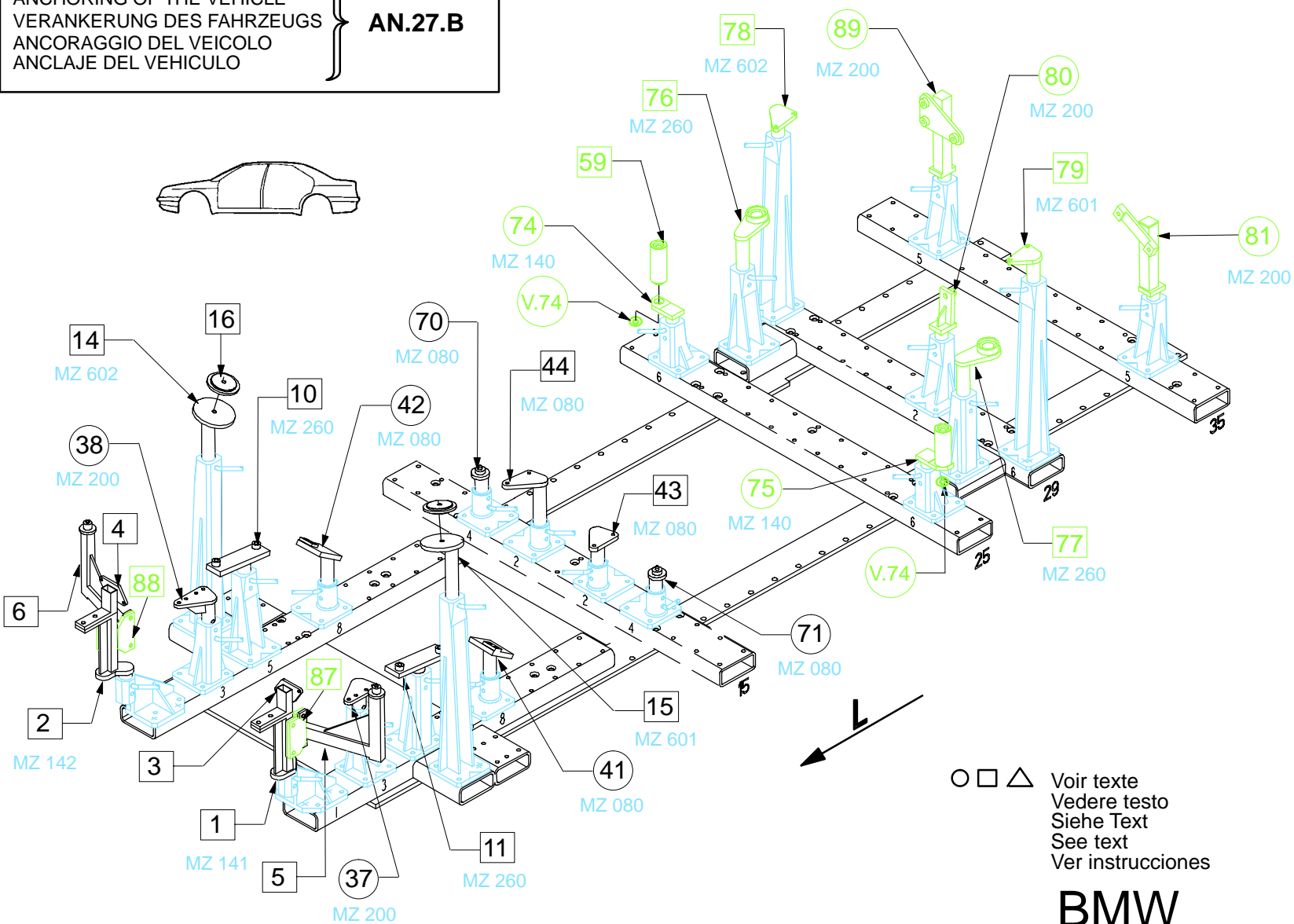

REP.	REFERENCE	PDS	NB	MZ
59	597.759	1,7	2	
60	597.760	0,3	2	
74	597.774	1,4	1	140
75	597.775	1,4	1	140
76	597.776	2,8	1	260
77	597.777	2,8	1	260
78	597.778	1,2	1	602
79	597.779	1,2	1	601
80	597.780	2,1	1	200
81	597.781	3,0	1	200
89	597.789	3,7	1	200
87	597.787	1,7	1	
88	597.788	1,7	1	
	V.74	0,1	2	

	M 8x30	4
	M 12x25	4
	M 12x40	4
	M 14.150x20	2
	M 8	4
	M 12	4

complément au
complementary set to
complemento al
zusatz zu **597.330**

597.301

28 Kg 30.09.97 406-D-12X

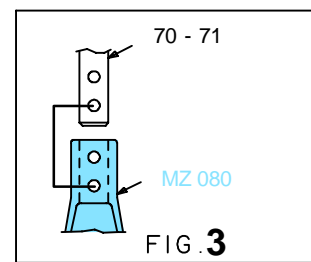
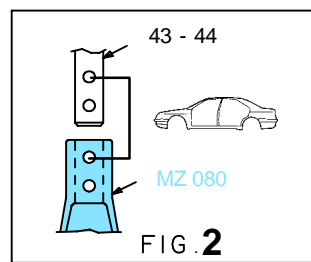
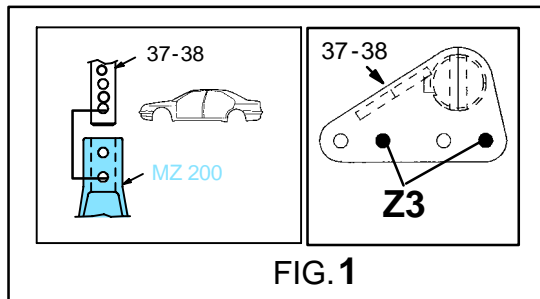
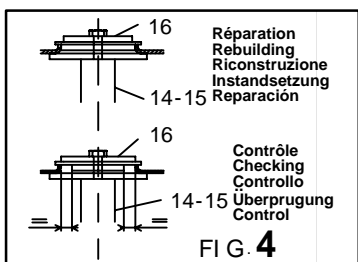
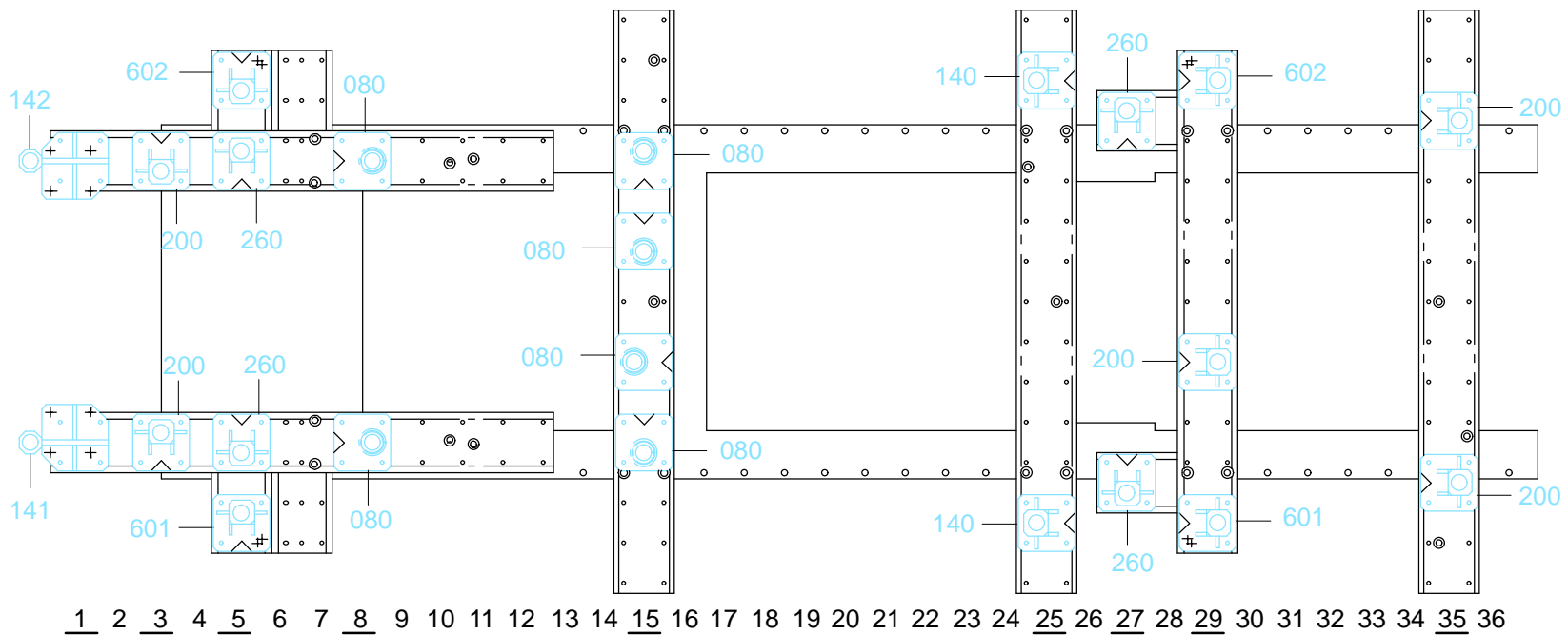

ANCORAGE DU VEHICULE
ANCHORING OF THE VEHICLE
VERANKERUNG DES FAHRZEUGS
ANCORAGGIO DEL VEICOLO
ANCLAJE DEL VEHICULO

AN.27.B

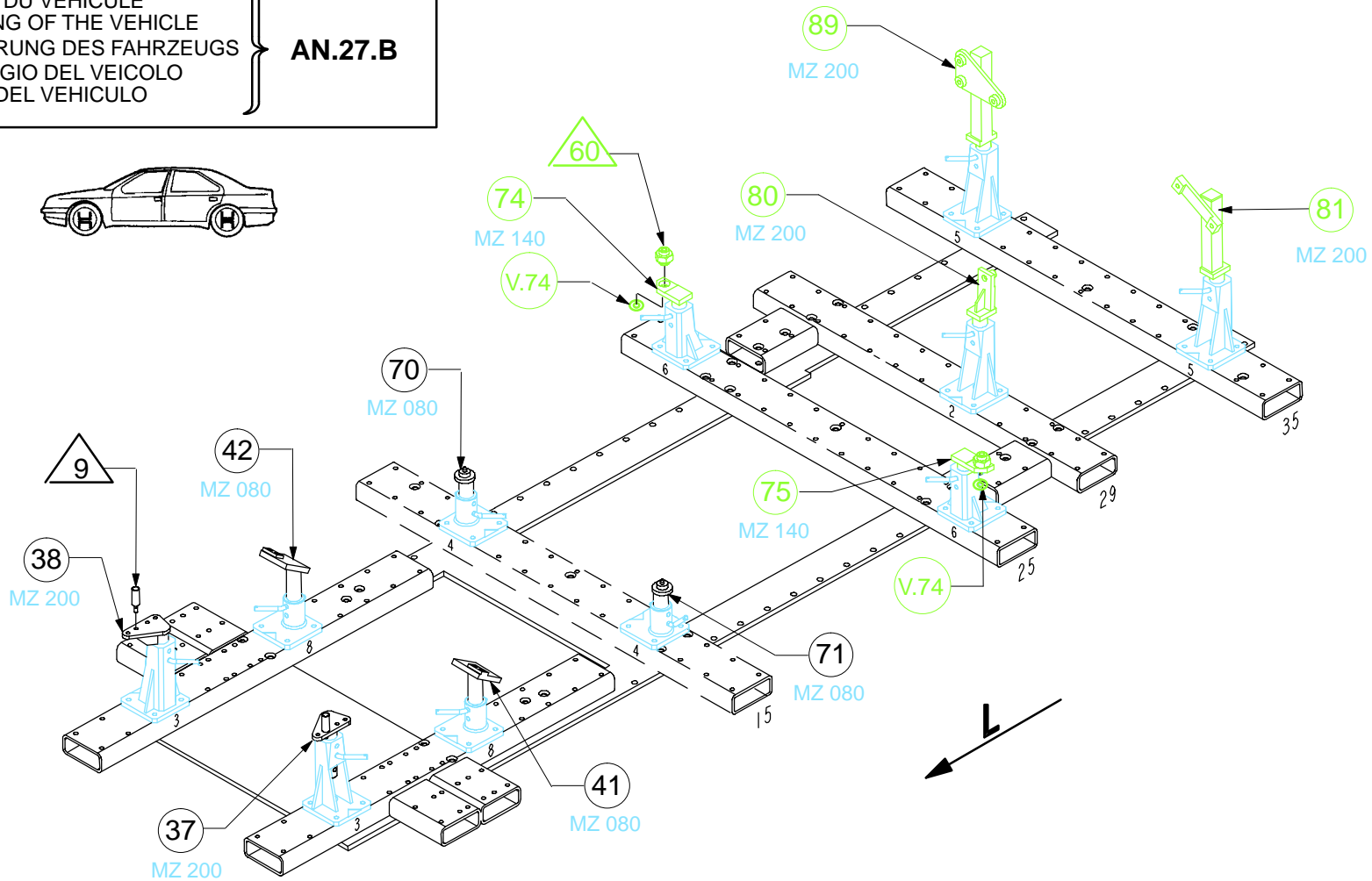

BMW

597.301

28 Kg | 30.09.97 | 406-D-12Y

