

REP.	REFERENCE	PDS	NB	MZ
23	592.723	1,7	1	080
24	592.724	1,7	1	080
25	592.725	1,2	1	
26	592.726	1,4	1	
27	592.727	4,6	1	260
28	592.728	4,6	1	260
29	592.729	1,0	2	
B37	B37A	0,4	4	

M12.125x40
 M14.150x30

complément au
 complementary set to
 complemento al
 zusatz zu

592.300

TOYOTA

592.309

19 Kg 01.03.91 434-D-34C

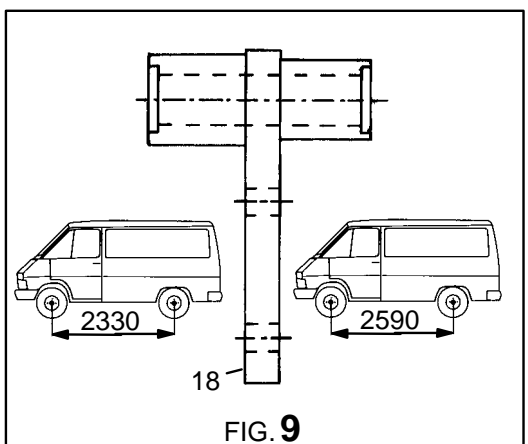
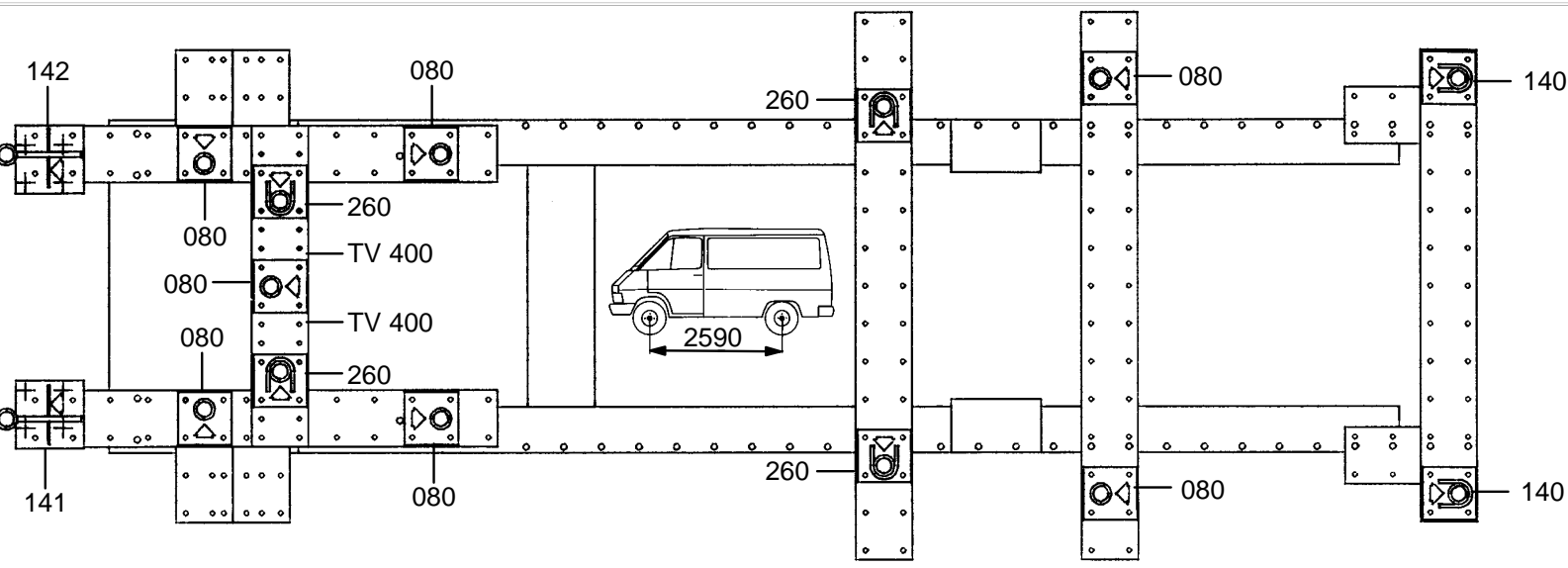
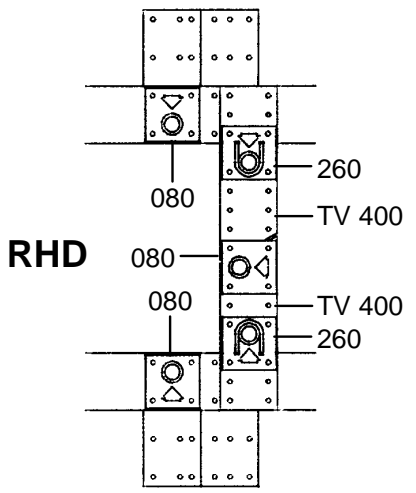

FIG. 9

1 2 3 4 5 6 7 8 9 10 11 12 13 14 15 16 17 18 19 20 21 22 23 24 25 26 27 28 29 30 31 32 33 34 35 36



RHD

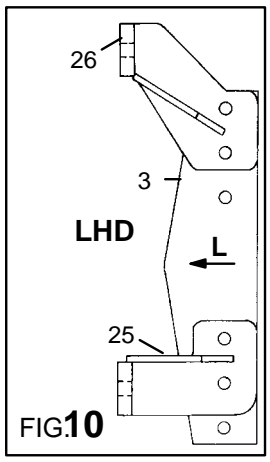

FIG.10

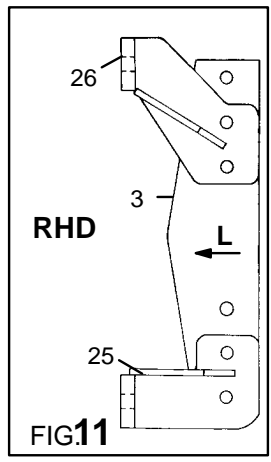
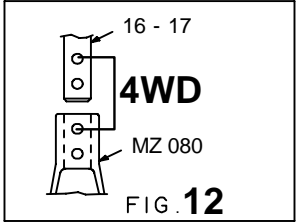
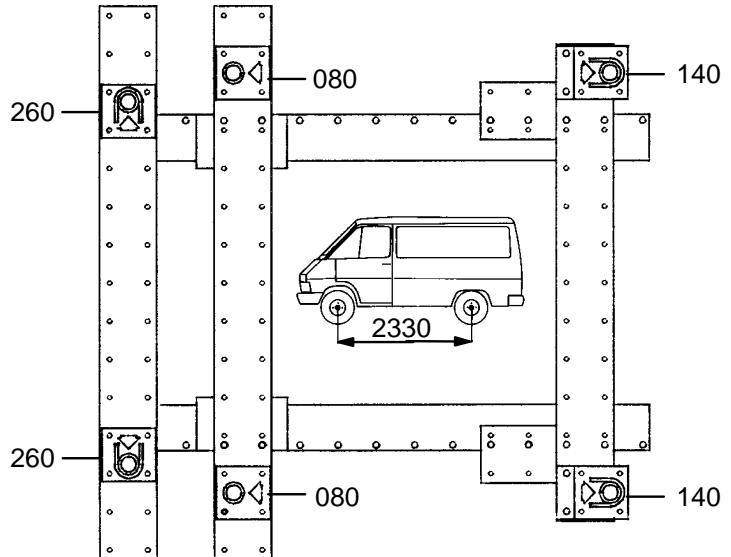

FIG.11



4WD

FIG. 12

4 5 6 7 8

23 24 25 26 27 28 29 30 31 32 33 34 35 36