

REP.	REFERENCE	PDS	NB	MZ
1	572.701	3,2	1	260
2	572.702	3,2	1	260
3	572.703	2,2	1	200
4	572.704	2,2	1	200
5	572.705	0,7	2	
6	572.706	2,5	1	200
7	572.707	2,5	1	200
8	572.708	1,7	1	260
9	572.709	1,7	1	260
10	572.710	1,7	2	140
11	572.711	0,8	2	
12	572.712	3,2	2	
13	572.713	5,6	2	141/142
14	572.714	1,4	2	
	V.09	0,1	2	
	V.48	0,1	4	

	M12x20	4
	M12x30	4

○ Avec ou sans mécanique
 With or without mechanical elements
 Con o senza parti meccaniche
 Mit oder ohne aggregate
 Con ó sin mecanica desmontada

GME

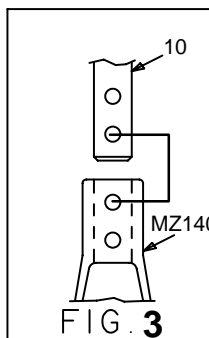
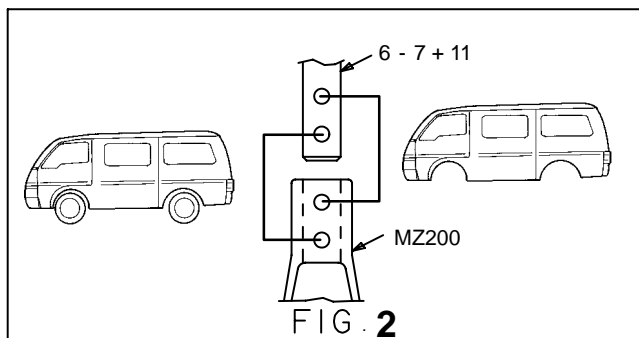
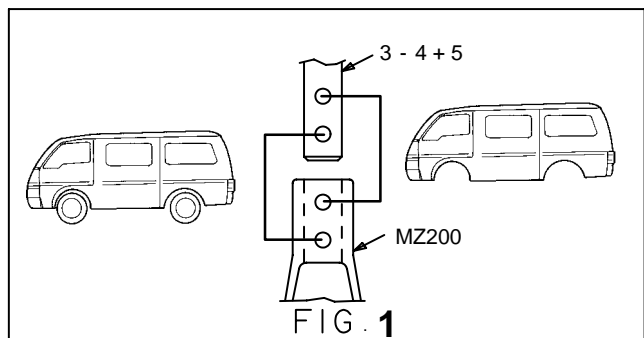
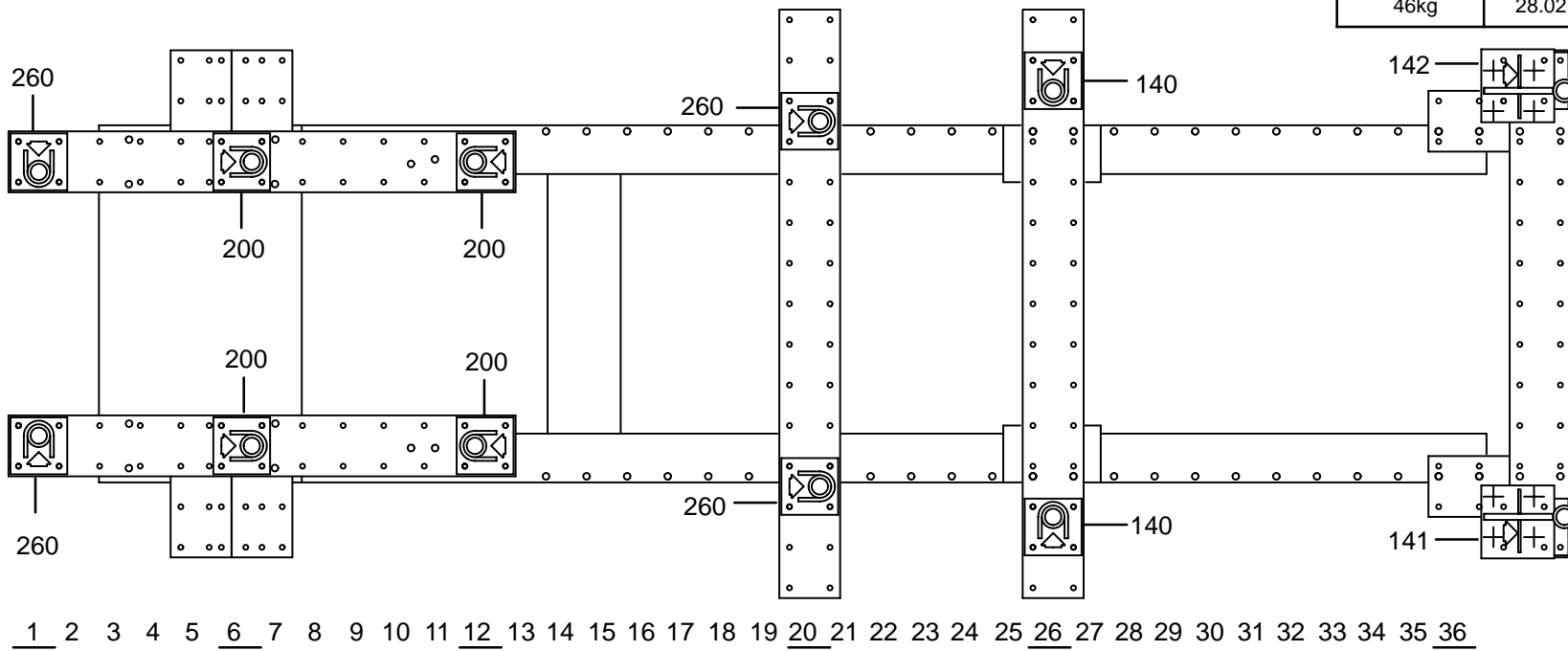

572.300

46kg 28.02.89 422-D-12A

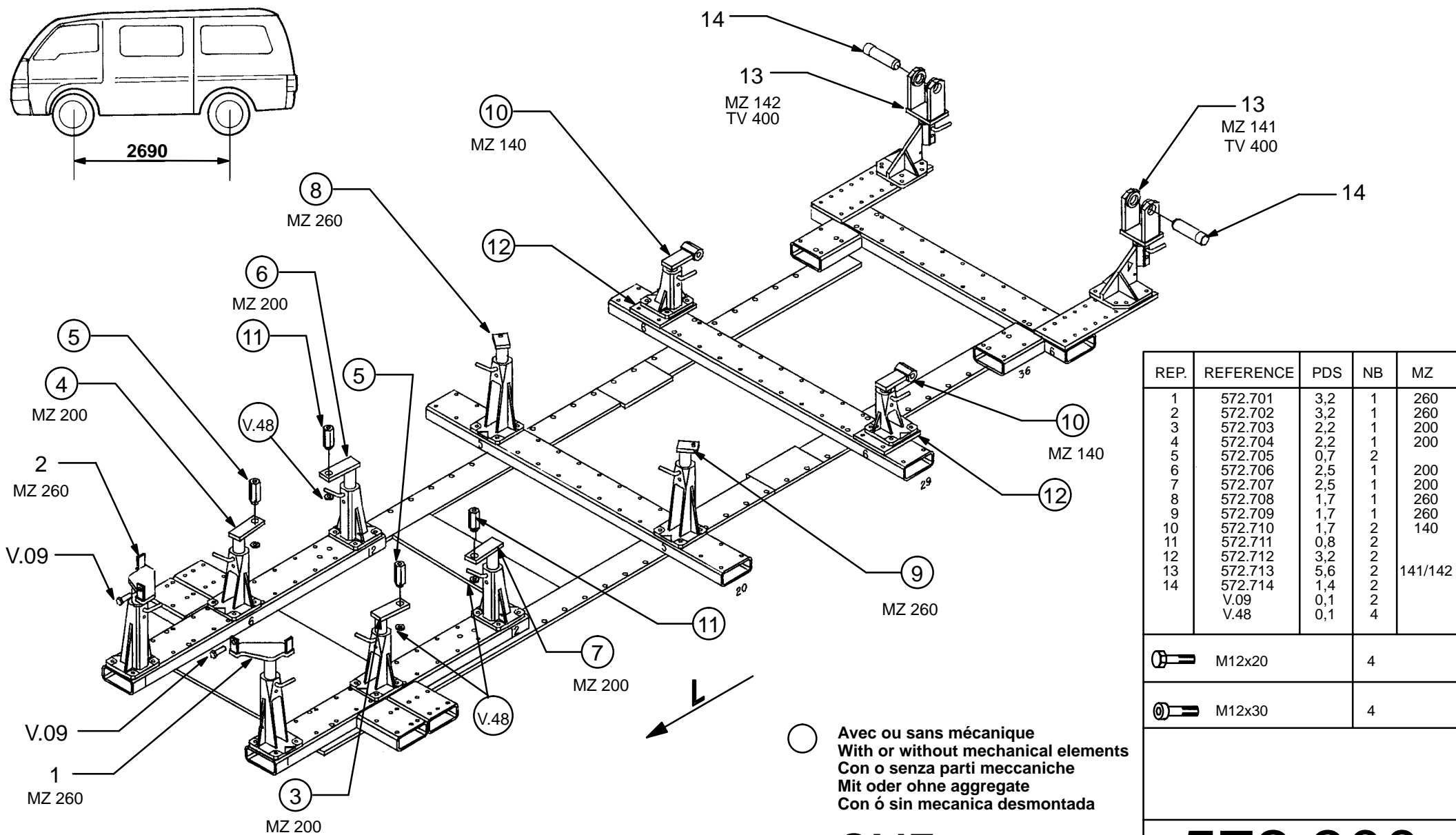



REP.	REFERENCE	PDS	NB	MZ
1	572.701	3,2	1	260
2	572.702	3,2	1	260
3	572.703	2,2	1	200
4	572.704	2,2	1	200
5	572.705	0,7	2	
6	572.706	2,5	1	200
7	572.707	2,5	1	200
8	572.708	1,7	1	260
9	572.709	1,7	1	260
10	572.710	1,7	2	140
11	572.711	0,8	2	
12	572.712	3,2	2	
13	572.713	5,6	2	141/142
14	572.714	1,4	2	
	V.09	0,1	2	
	V.48	0,1	4	

 M12x20	4
 M12x30	4

○ Avec ou sans mécanique
 With or without mechanical elements
 Con o senza parti meccaniche
 Mit oder ohne aggregate
 Con ó sin mecanica desmontada

GME

572.300

46kg | 28.02.89 | 422-D-12B

