

Pièces du 565.300
 * Parts of 565.300
 Teile aus 565.300
 Parti del 565.300
 Piezas del 565.300

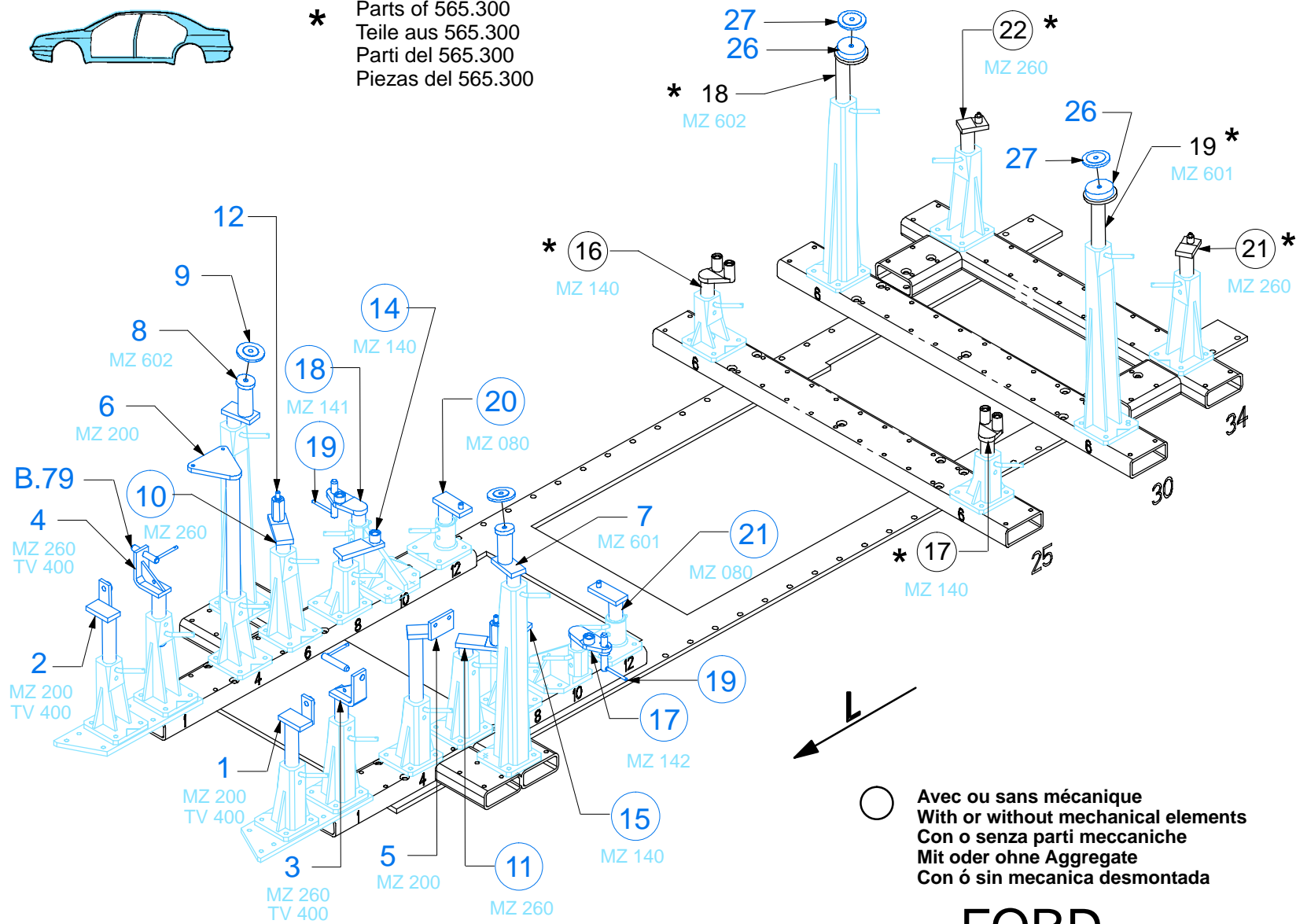
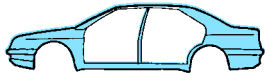

○ Avec ou sans mécanique
 With or without mechanical elements
 Con o senza parti meccaniche
 Mit oder ohne Aggregate
 Con ó sin mecanica desmontada

REP.	REFERENCE	PDS	NB	MZ
1	720.7001	1,8	1	200
2	720.7002	1,8	1	200
3	720.7003	1,7	1	260
4	720.7004	1,7	1	260
5	720.7005	2,3	1	200
6	720.7006	3,6	1	200
7	720.7007	1,7	1	601
8	720.7008	1,7	1	602
9	720.7009	0,3	2	
10	720.7010	1,7	1	260/080
11	720.7011	1,7	1	260/080
12	720.7012	0,5	2	
13	720.7013	0,9	2	
14	720.7014	1,8	1	140/080
15	720.7015	1,8	1	140/080
16	720.7016	0,04	2	
17	720.7017	1,9	1	142/080
18	720.7018	1,9	1	141/080
19	720.7019	0,3	2	
20	720.7020	1,2	1	080
21	720.7021	1,2	1	080
26	720.7026	0,5	2	
27	720.7027	0,3	2	
	B.79	0,2	2	

	M 8x25	2
	M 10x25	2
	M 12x20	2
	M 12x25	4
	M 12x60	4
	M 12x120	4
	M 14x35	2
	M 14	2
	M 12	2

complément au
 complementary set to
 complemento al
 zusatz zu **565.300**

565.308

37 Kg 11.01.96 412-D-14E

FORD

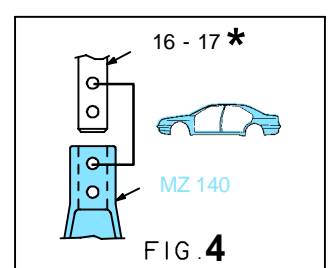
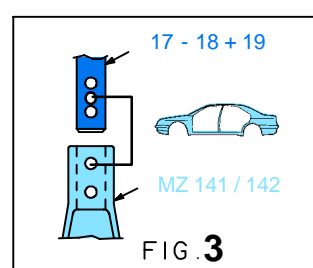
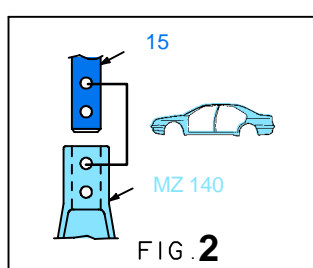
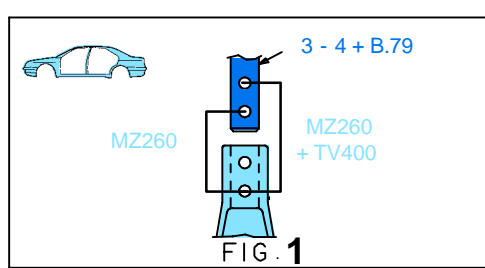
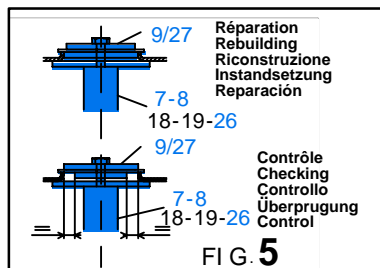
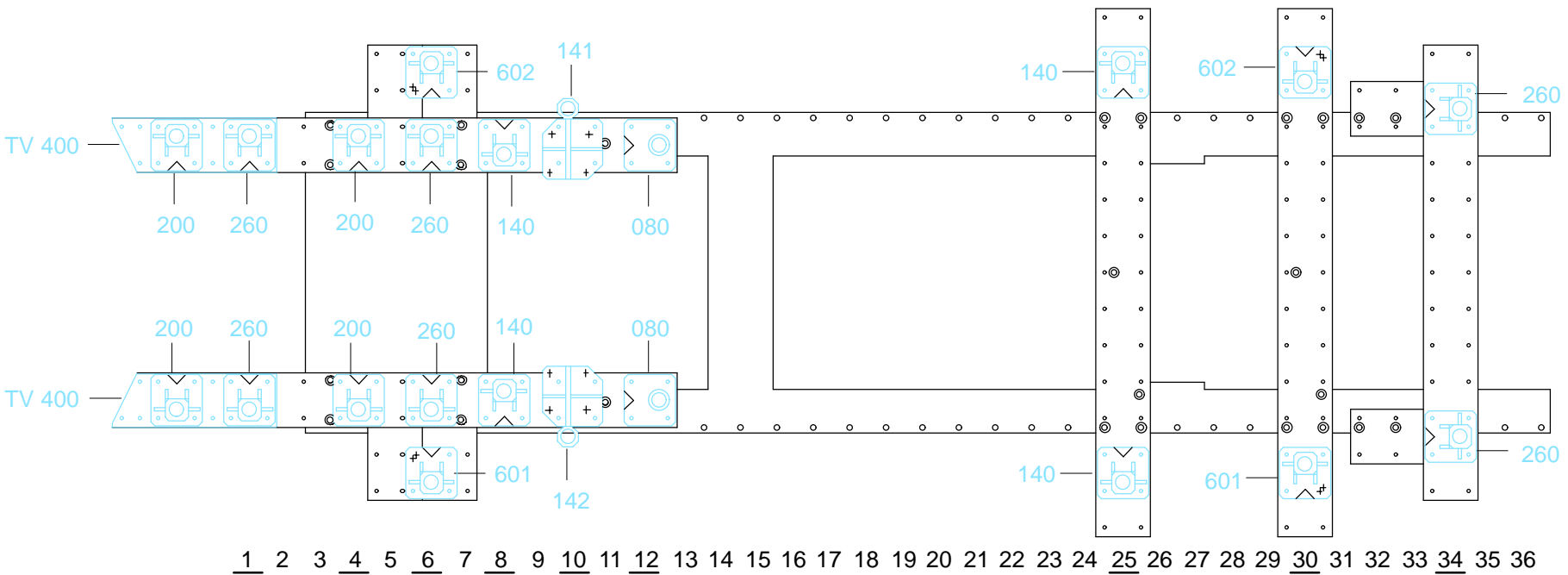

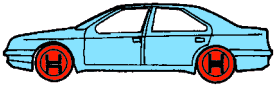

* Pièces du 565.300
 * Parts of 565.300
 * Teile aus 565.300
 * Parti del 565.300
 * Piezas del 565.300

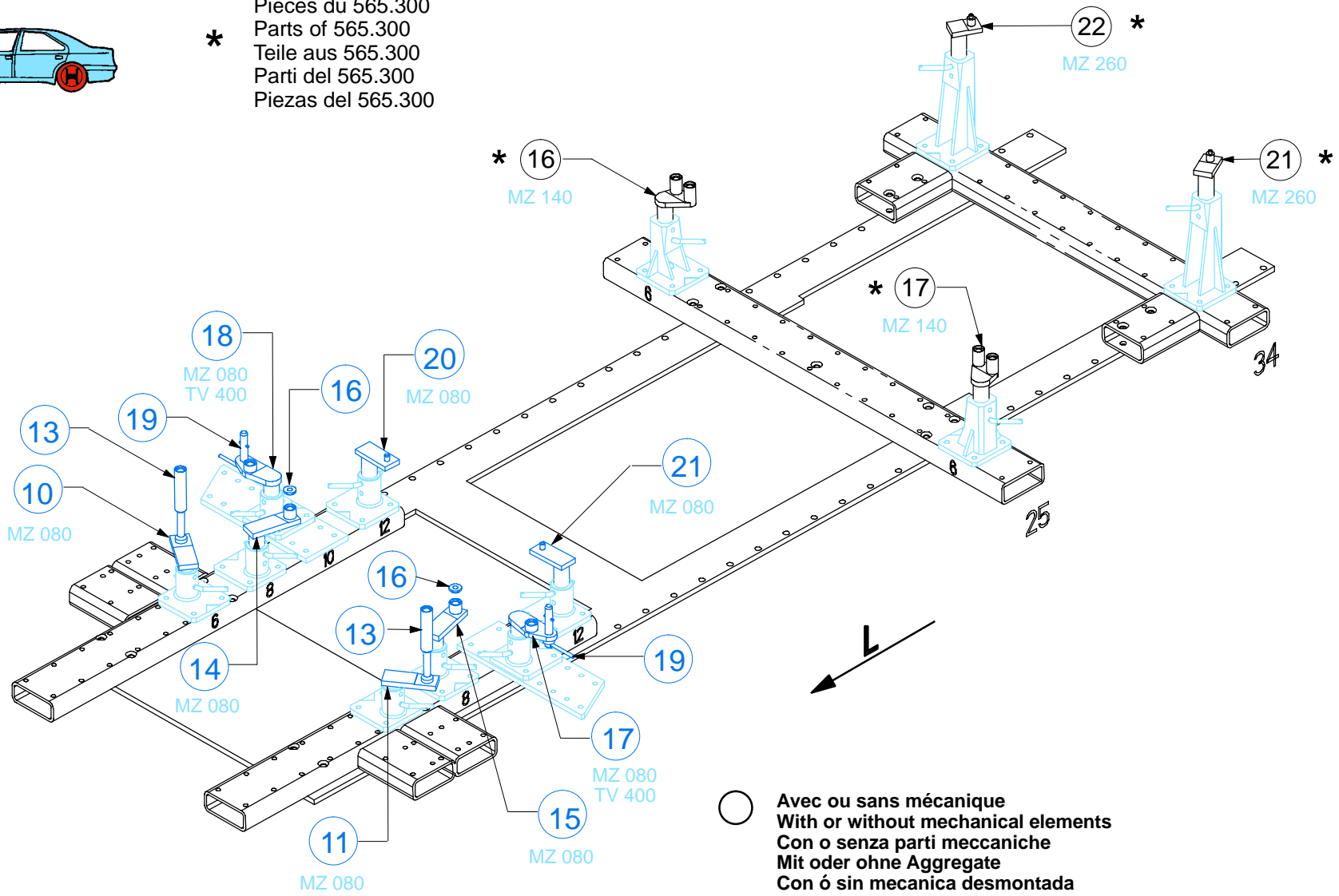

○ Avec ou sans mécanique
 With or without mechanical elements
 Con o senza parti meccaniche
 Mit oder ohne Aggregate
 Con ó sin mecánica desmontada

FORD

565.308

37 Kg | 23.11.95 | 412-D-14F

