

REP.	REFERENCE	PDS	NB	PISTON	MZ
1	2528.5001	0,7	1	P100	601
2	2528.5002	0,7	1	P100	602
3	2528.5003	1,4	1	P160	140/080
4	2528.5004	1,4	1	P160	140/080
5	2528.5005	1,1	1	P310	141
6	2528.5006	1,1	1	P310	142
7	2528.5007	1,0	1	P220	260
8	2528.5008	1,2	1	P220	260
9	2528.5009	1,2	1	P220	601
10	2528.5010	1,2	1	P220	602
11	2528.5011	0,4	2		
12	2528.5012	0,2	2		
13	2528.5013	0,7	1	P160/100	140/080
14	2528.5014	0,7	1	P160/100	140/080
15	2528.5015	2,0	1	P100	080
16	2528.5016	2,0	1	P100	080
17	2528.5017	0,6	1	P100	080
18	2528.5018	0,6	1	P100	080
19	2528.5019	1,6	1	P160	140
20	2528.5020	1,6	1	P160	140
21	2528.5021	0,4	2		
22	2528.5022	0,05	2		
23	2528.5023	0,03	2		
24	2528.5024	0,6	1	P220	200
25	2528.5025	0,6	1	P220	200
26	2528.5026	1,7	1	P310	260
27	2528.5027	1,7	1	P310	260
29	2528.5029	0,8	1	P160	260/200
30	2528.5030	0,8	1	P160	260/200
31	2528.5031	0,2	2		
32	2528.5032	1,6	1	P160	200
33	2528.5033	1,6	1	P160	200
34	2528.5034	1,1	2		
35	2528.5035	0,2	2		
A	MZ2500.CR500B	6,5	1		
B	MR.2528.500	0,2	1		

M 8-45	4
M 8-50	3
M 12-25	2
M 12-30	10
M 12-100	2
M 12-130	2
M 12-180	2
M 12-220	2
M 14-100	4
M 14-150	4

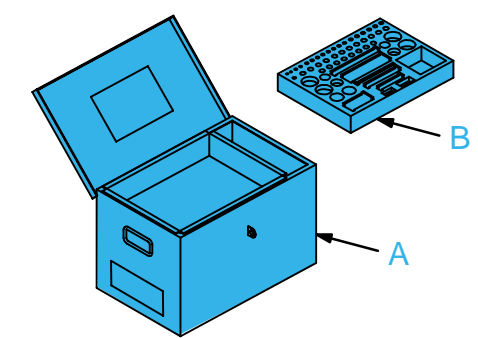

○ Avec ou sans mécanique
With or without mechanical elements
Con o senza parti meccaniche
Mit oder ohne Aggregate
Con ó sin mecanica desmontada

2528.500

45 Kg	13.10.2008	422-D-32A
2528.500-RVA3-1		00



OPEL

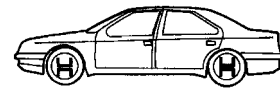
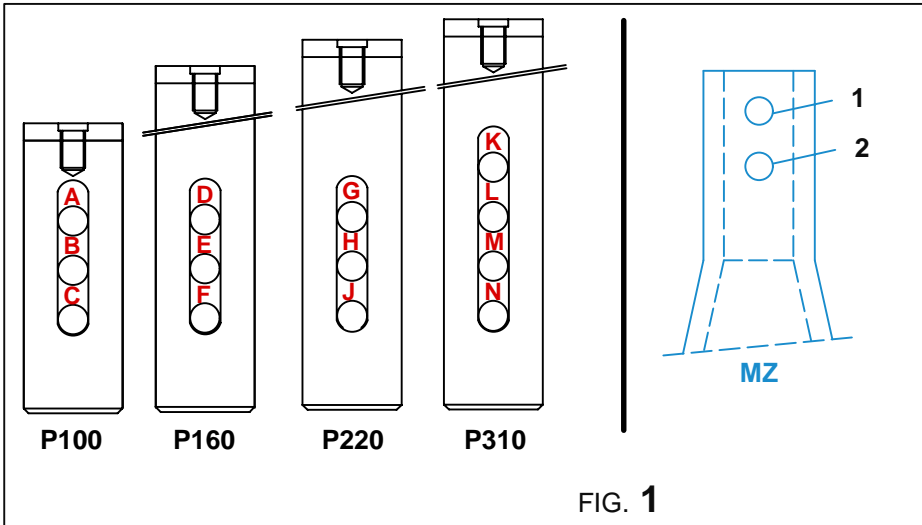

2WD

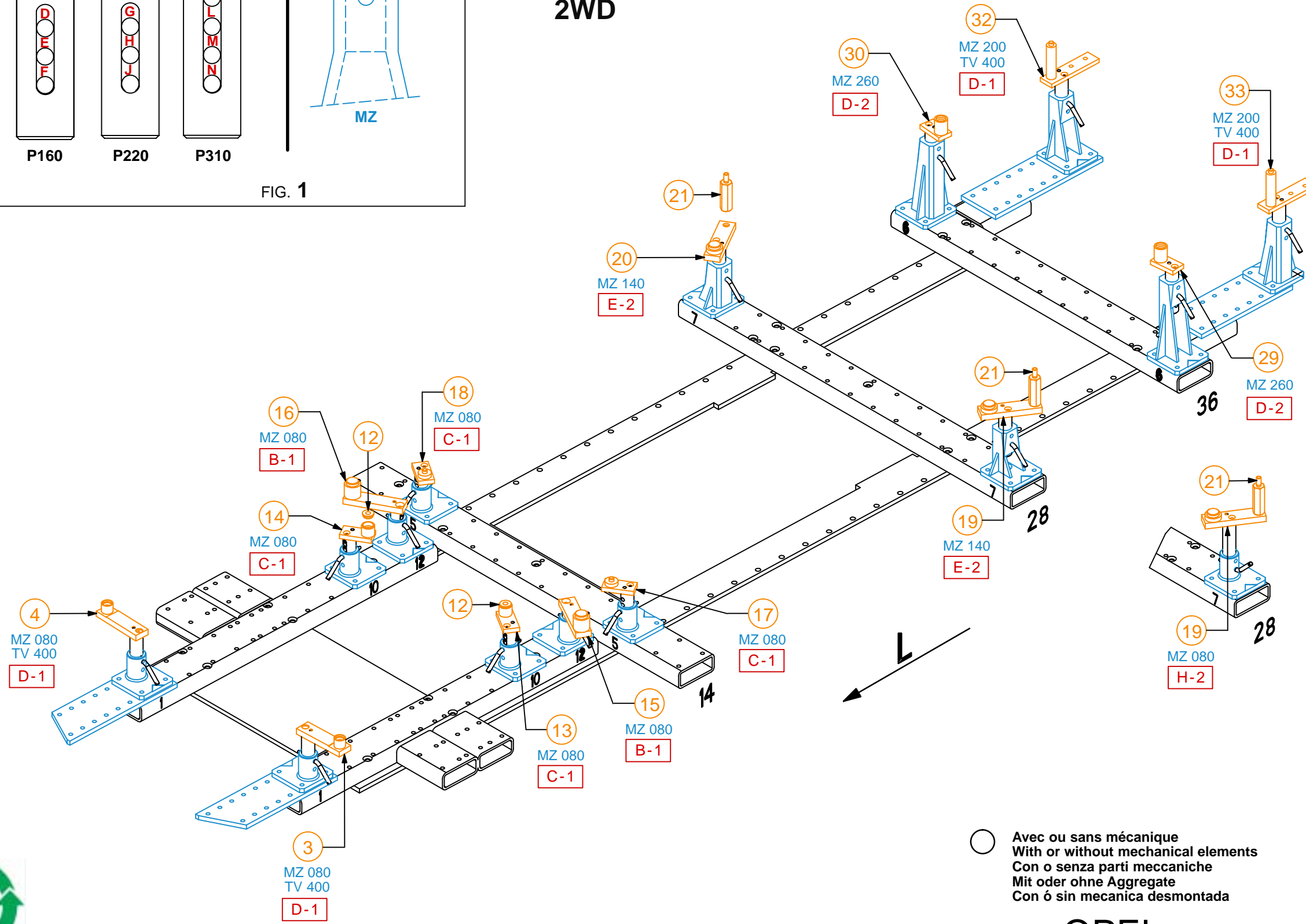

OPEL

2528.500

45 Kg	13.10.2008	422-D-32B
2528.500-RVA3-1		00



2WD / 4WD

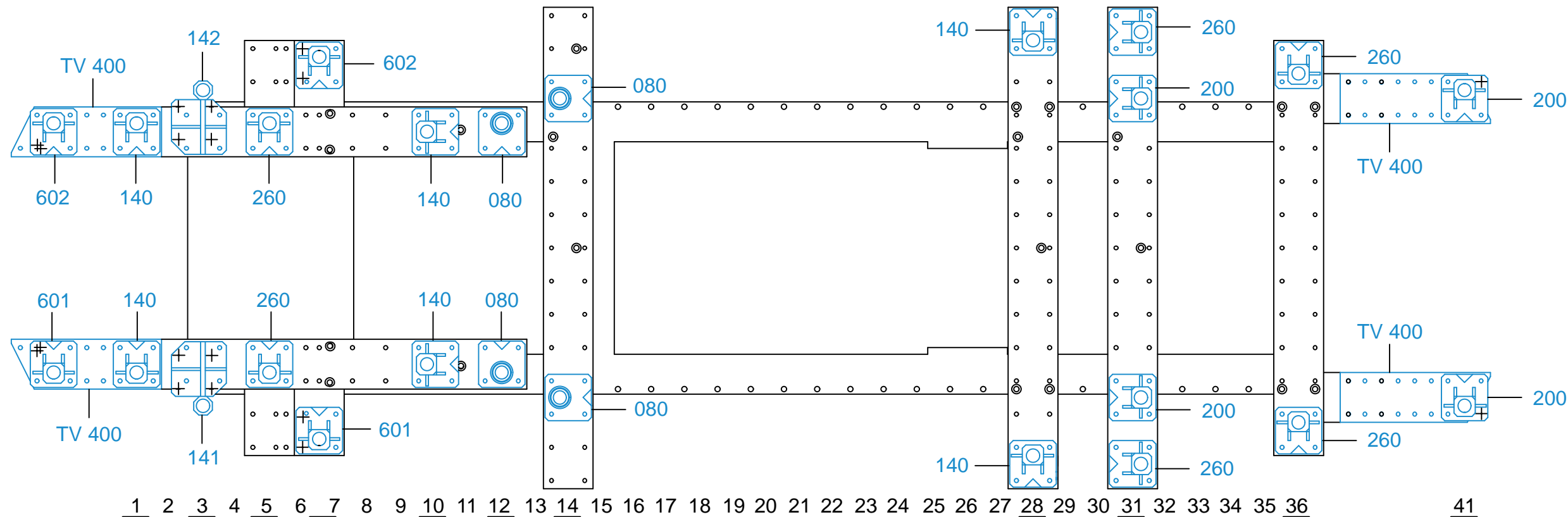

1 - 2	3 - 4 + 35	5 - 6	7 - 8	9 - 10 + 11	13 - 14 + 12	15 - 16	17 - 18
P100	P160	P310	P220	P220	P160	P100	P100
C	E	M	J	J	D	B	C
1	2	1	1	1	2	1	1
MZ 601 / 602 + TV 400	MZ 140 + TV 400	MZ 141/142	MZ 260	MZ 601 / 602	MZ 140	MZ 080	MZ 080
FIG. 2	FIG. 3	FIG. 4	FIG. 5	FIG. 6	FIG. 7	FIG. 8	FIG. 9

19 - 20 + 21 + 22	24 - 25	26 - 27	29 - 30 + 31	32 - 33 + 34
P160	P220	P310	P160	P160
E	G	N	F	D
2	2	1	2	1
MZ 140	MZ 200	MZ 260	MZ 260	MZ 200 + TV 400
FIG. 10	FIG. 11	FIG. 12	FIG. 13	FIG. 14

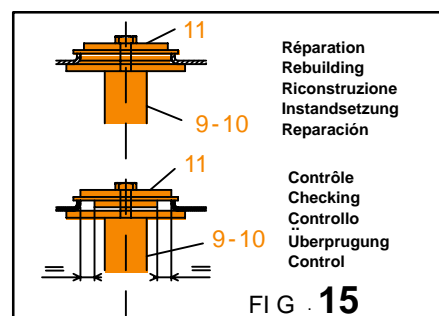

○ Avec ou sans mécanique
With or without mechanical elements
Con o senza parti meccaniche
Mit oder ohne Aggregate
Con ó sin mecanica desmontada

OPEL

2528.500		
45 Kg	13.10.2008	422-D-32C
2528.500-RVA3-2		00



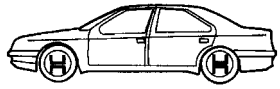

2WD

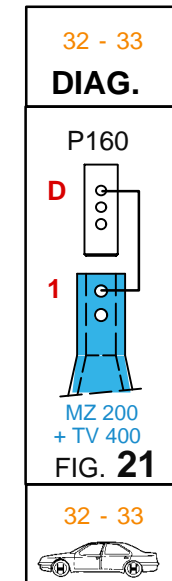
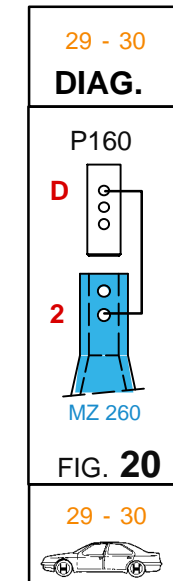
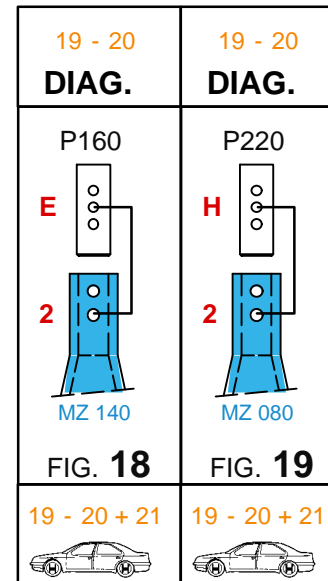
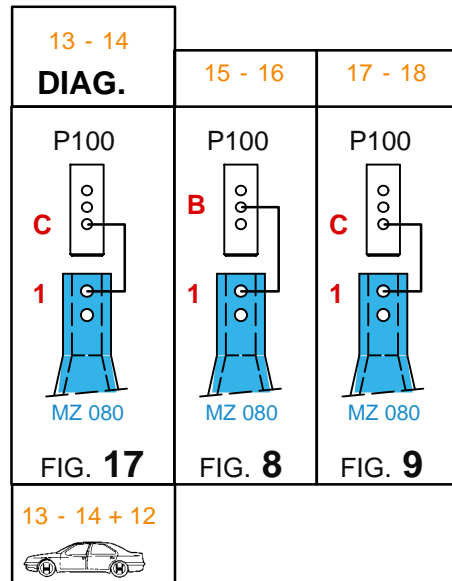
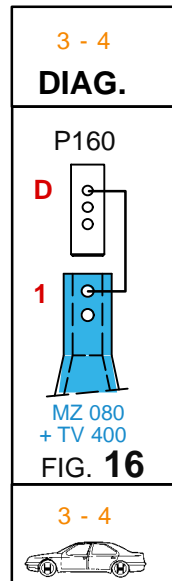
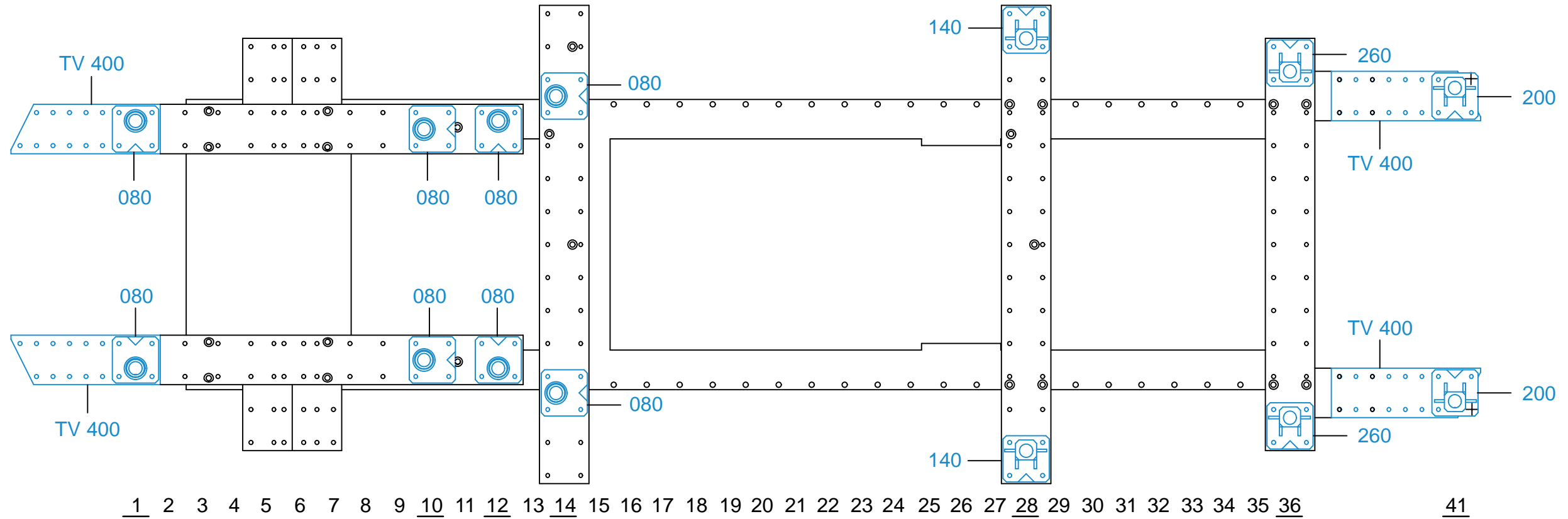

○ Avec ou sans mécanique
With or without mechanical elements
Con o senza parti meccaniche
Mit oder ohne Aggregate
Con ó sin mecanica desmontada

OPEL

2528.500		
45 Kg	13.10.2008	422-D-32D
2528.500-RVA3-2		00



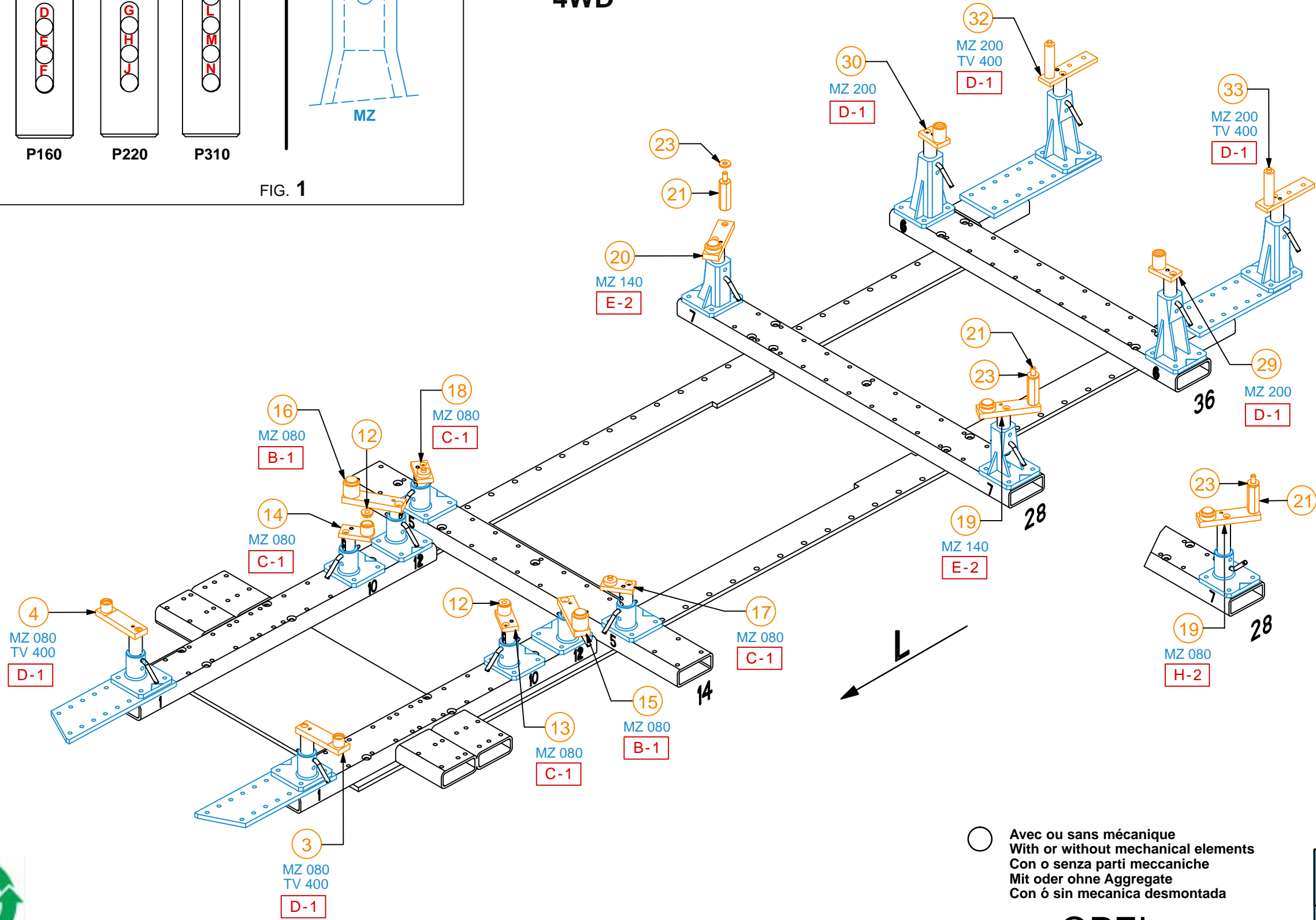
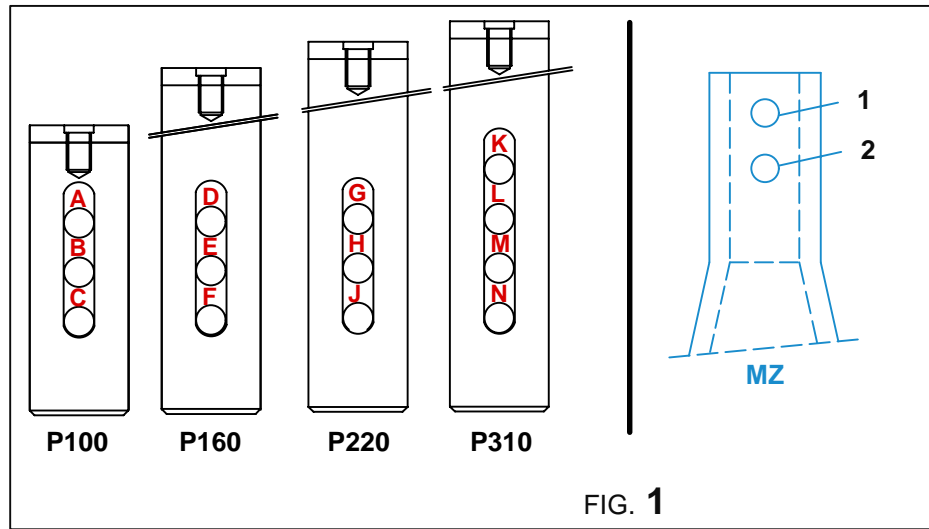

○ Avec ou sans mécanique
 With or without mechanical elements
 Con o senza parti meccaniche
 Mit oder ohne Aggregate
 Con ó sin mecanica desmontada

2528.500

45 Kg	13.10.2008	422-D-32E
2528.500-RVA3-3		00

OPEL

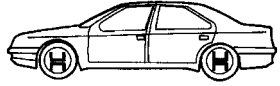

4WD

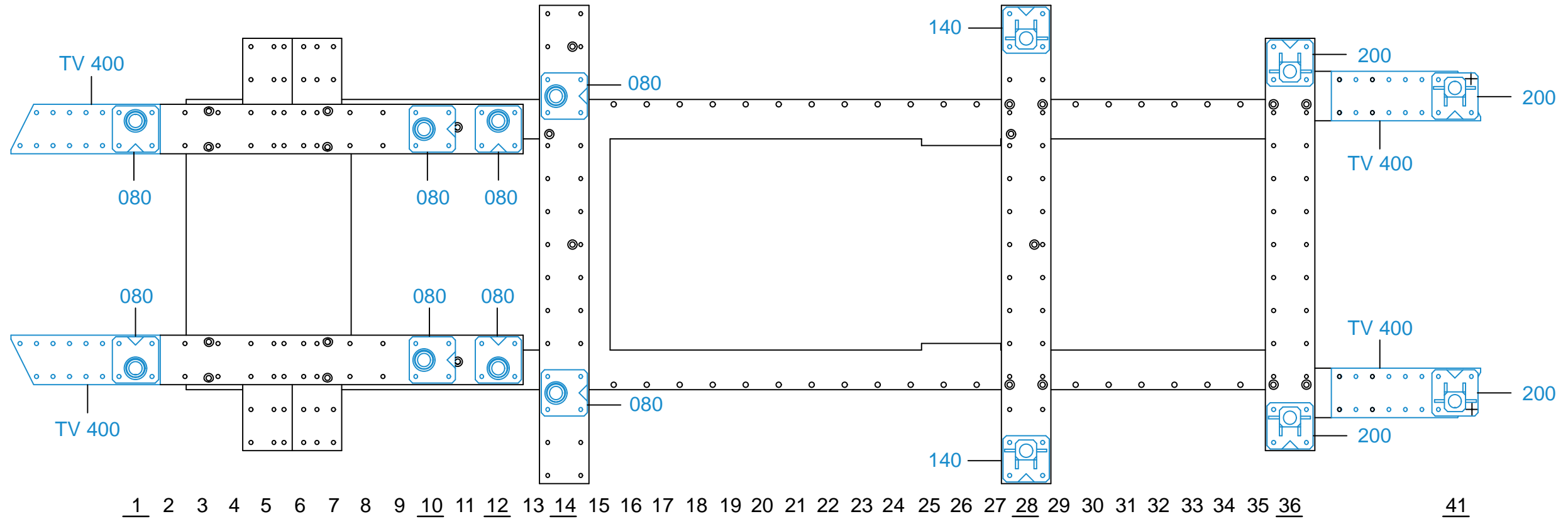

3 - 4
DIAG.

P160
D
1
MZ 080 + TV 400
FIG. 16

3 - 4

13 - 14 DIAG.	15 - 16	17 - 18
P100 C 1 MZ 080 FIG. 17	P100 B 1 MZ 080 FIG. 8	P100 C 1 MZ 080 FIG. 9
13 - 14 + 12 		

19 - 20 DIAG.	19 - 20 DIAG.
P160 E 2 MZ 140 FIG. 22	P220 H 2 MZ 080 FIG. 23
19 - 20 + 21 + 23 	19 - 20 + 21 + 23

29 - 30
DIAG.

P160
D
1
MZ 200
FIG. 24

29 - 30

32 - 33
DIAG.

P160
D
1
MZ 200 + TV 400
FIG. 21

32 - 33

○ Avec ou sans mécanique
With or without mechanical elements
Con o senza parti meccaniche
Mit oder ohne Aggregate
Con ó sin mecánica desmontada

OPEL

2528.500		
45 Kg	13.10.2008	422-D-32F
2528.500-RVA3-3		00

