

REP.	REFERENCE	PDS	NB	PISTON	MZ
1	2518.5001	1,4	1	P310	200
2	2518.5002	1,4	1	P310	200
3	2518.5003	0,6	1	P160	260/140
4	2518.5004	0,6	1	P160	260/140
5	2518.5005	0,6	2		
6	2518.5006	1,0	1	P220	602
7	2518.5007	1,0	1	P220	601
8	2518.5008	1,1	2		
9	2518.5009	0,7	1	P160	260
10	2518.5010	0,7	1	P160	260
11	2518.5011	0,5	1	P100	140/080
12	2518.5012	0,5	1	P100	140/080
13	2518.5013	0,2	2		
14	2518.5014	0,1	2		
15	2518.5015	0,8	1	P100	080
16	2518.5016	0,8	1	P100	080
17	2518.5017	0,7	1	P160	140
18	2518.5018	0,7	1	P160	140
19	2518.5019	0,7	1	P160	200/080
20	2518.5020	0,7	1	P160	200/080
21	2518.5021	0,5	2		
22	2518.5022	1,4	1	P100	602
23	2518.5023	1,4	1	P100	601
24	2518.5024	0,4	2		
25	2518.5025	0,6	1	P220/160	260/200
26	2518.5026	0,6	1	P220/160	260/200
27	2518.5027	0,2	2		
28	2518.5028	0,8	1	P310	142
29	2518.5029	0,8	1	P310	141
	V32	0,1	2		
A	MZ2500.CR500B	6,5	1		
B	MR.2518.500	0,2	1		

M 10-40	4
M 12-35	2
M 12-70	2
M 14-30	6
M 14-80	2
M 14-90	2
M 14-110	2
M 16-50	2
M 16-80	2
M 16-90	2
M 16-200	2
M 14	6

○ Avec ou sans mécanique
With or without mechanical elements
Con o senza parti meccaniche
Mit oder ohne Aggregate
Con ó sin mecanica desmontada

GM

2518.500

34 Kg	27.05.2008	440-D-28A
2518.500-RVA3-1		00





CELETTE®

GM

CADILLAC

CTS

MOD. 2008

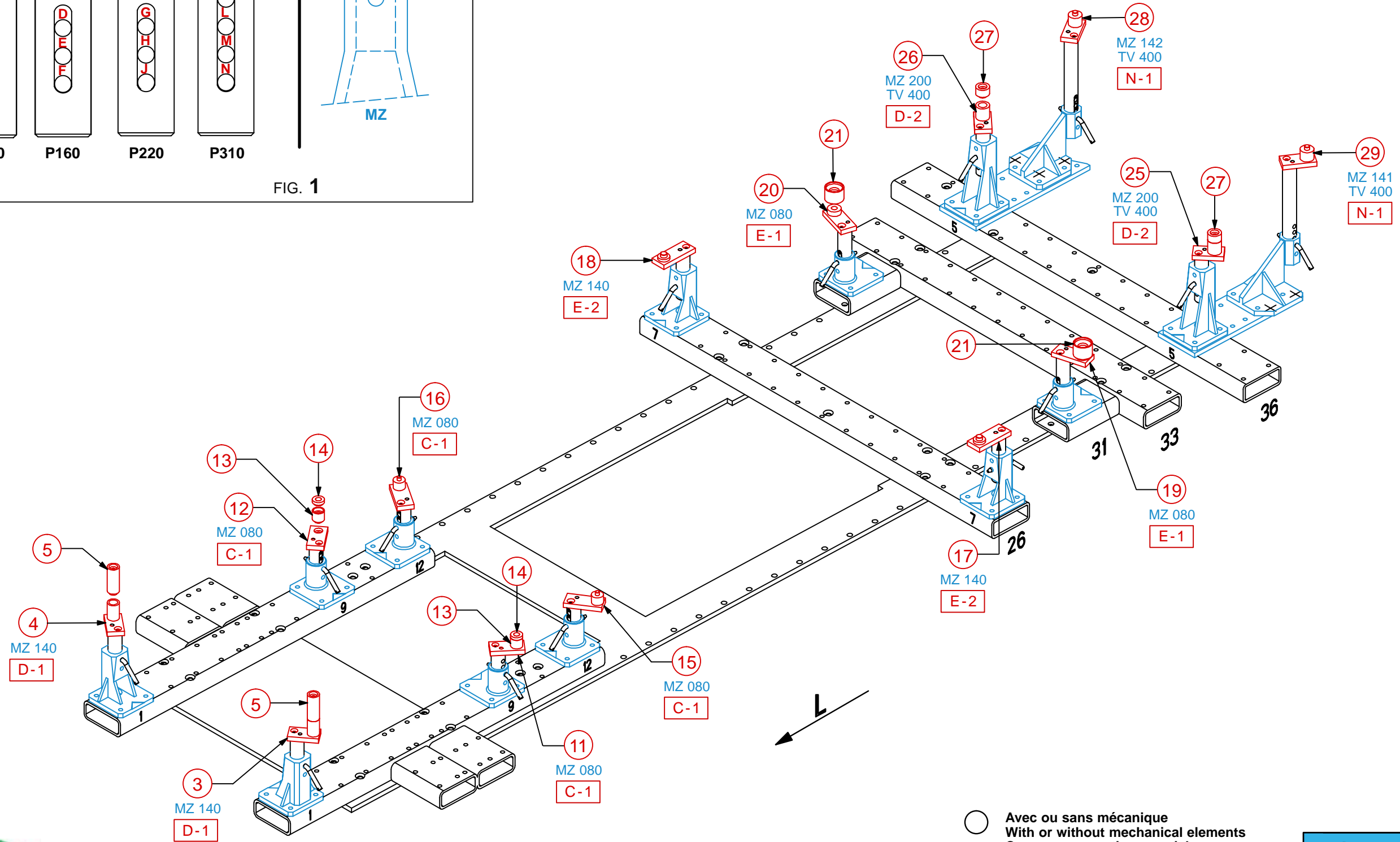
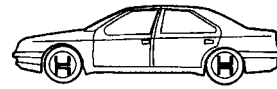
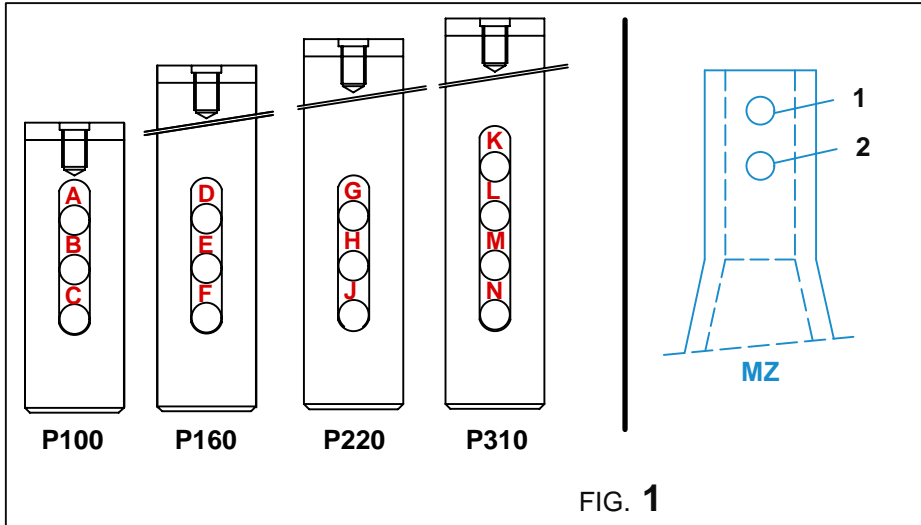

○ Avec ou sans mécanique
 With or without mechanical elements
 Con o senza parti meccaniche
 Mit oder ohne Aggregate
 Con ó sin mecanica desmontada

GM

2518.500

34 Kg	27.05.2008	440-D-28B
2518.500-RVA3-1		00



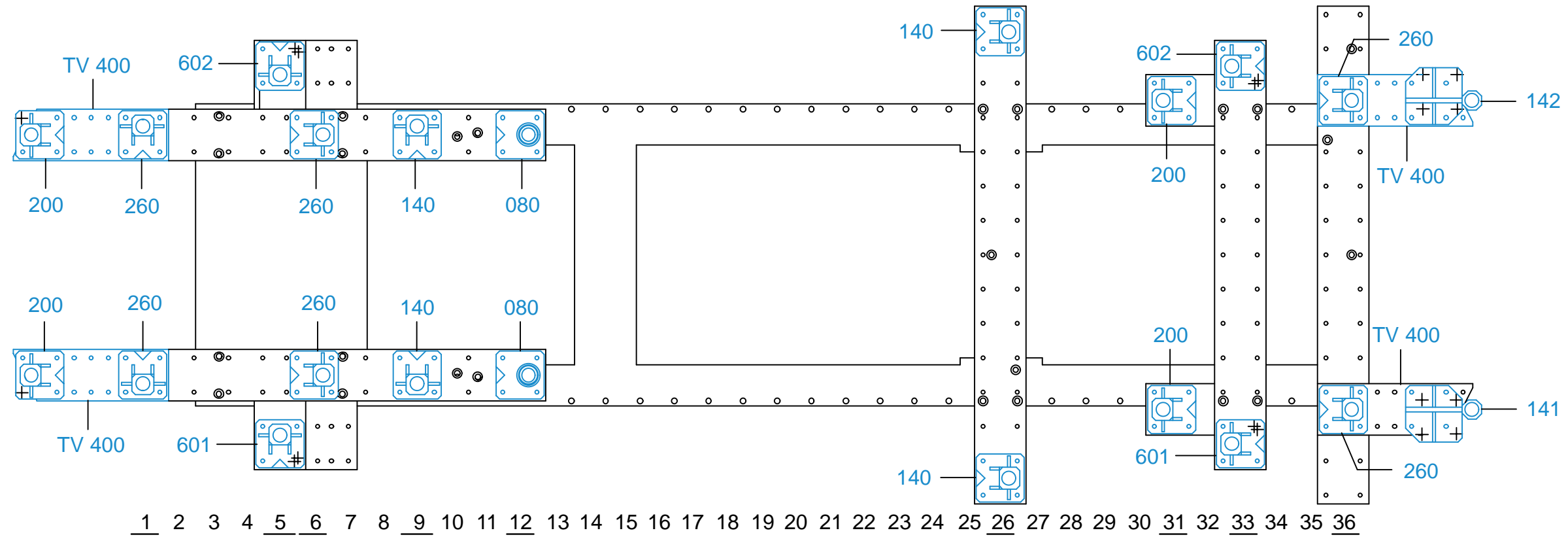

1 - 2	3 - 4	6 - 7 + 8	9 - 10	11 - 12	15 - 16
P310 K	P160 D	P220 H	P160 F	P100 C	P100 C
MZ 200 + TV 400	MZ 260 + TV 400	MZ 601 / 602	MZ 260	MZ 140	MZ 080
FIG. 2	FIG. 3	FIG. 4	FIG. 5	FIG. 6	FIG. 7

17 - 18	19 - 20	22 - 23 + 24	25 - 26	28 - 29
P160 E	P160 F	P100 A	P220 H	P310 N
MZ 140	MZ 200	MZ 601 / 602	MZ 260 + TV 400	MZ 141 / 142 + TV 400
FIG. 8	FIG. 9	FIG. 10	FIG. 11	FIG. 12

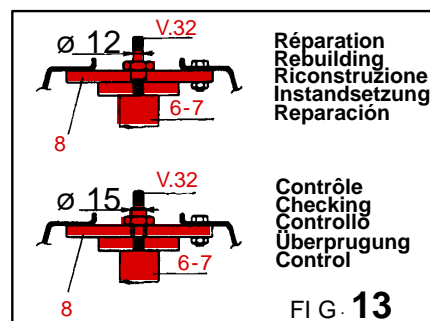

Avec ou sans mécanique
 With or without mechanical elements
 Con o senza parti meccaniche
 Mit oder ohne Aggregate
 Con ó sin mecanica desmontada

GM

2518.500		
34 Kg	27.05.2008	440-D-28C
2518.500-RVA3-2		00



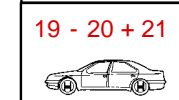
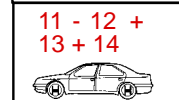
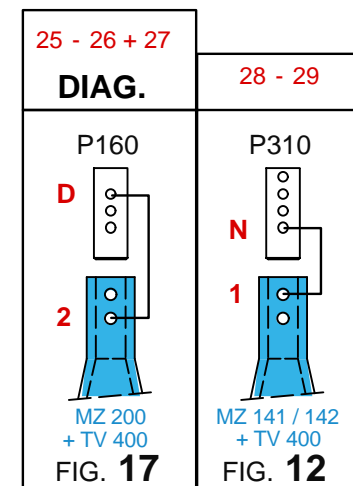
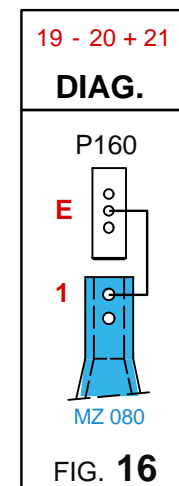
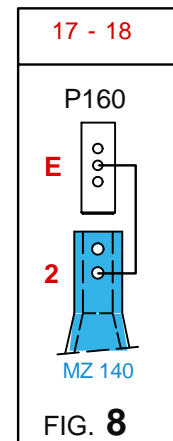
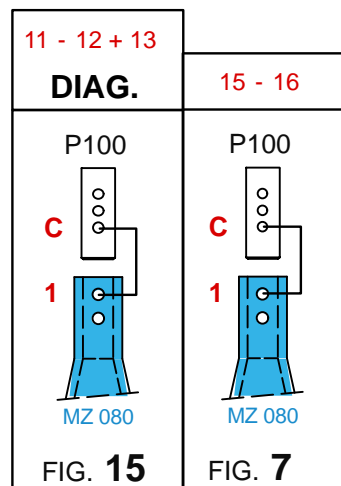
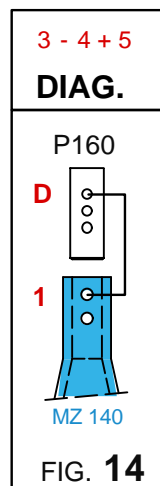
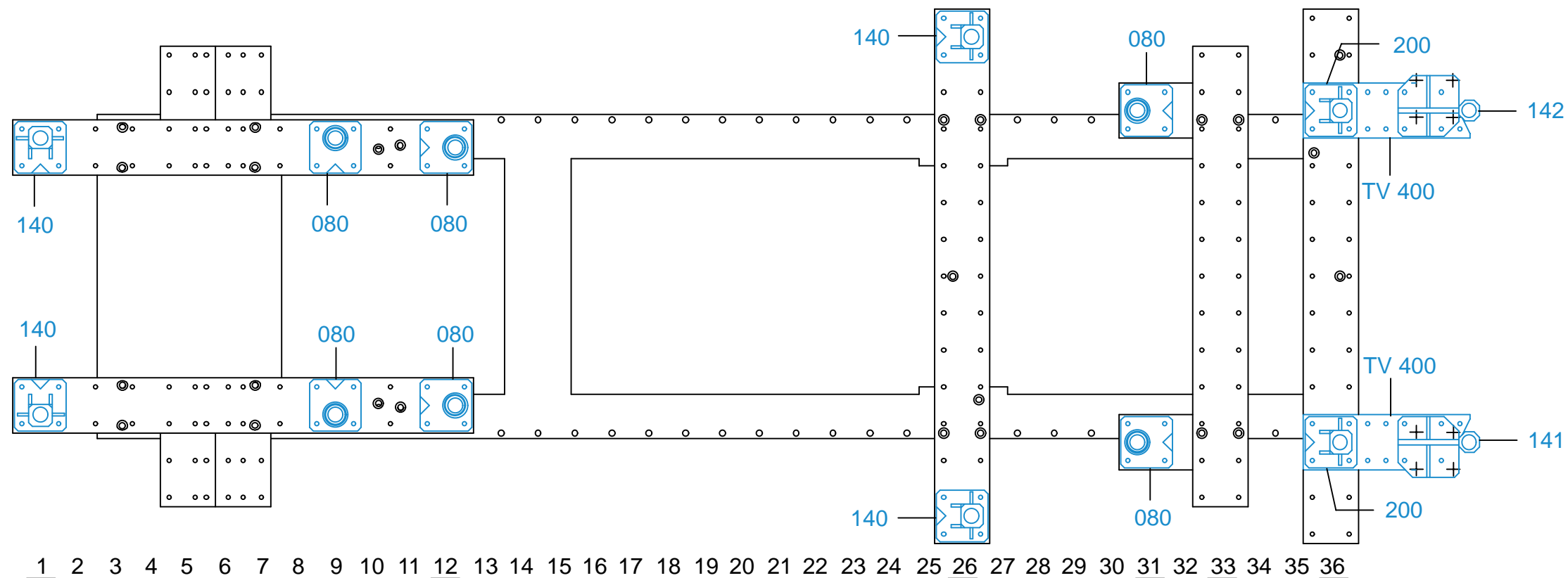
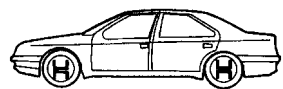

○ Avec ou sans mécanique
With or without mechanical elements
Con o senza parti meccaniche
Mit oder ohne Aggregate
Con ó sin mecanica desmontada



GM

2518.500		
34 Kg	27.05.2008	440-D-28D
2518.500-RVA3-2		00