

REP.	REFERENCE	PDS	NB	PISTON	MZ
39	2516.5039	0,6	2		
40	2516.5040	0,6	1	P220	200
41	2516.5041	0,9	1	P220	200
42	2516.5042	1,7	1	P310	260
43	2516.5043	1,7	1	P310	260
44	2516.5044	1,4	1	P310/160	140
45	2516.5045	1,2	1	P310/160	140
	CDT.040	1,5	8		

M 8-25	4
M 10-25	2
M 12x1,25-50	2
M 12x1,25-220	2
955714	16
TFHc 16-60	16

complément au  
complementary set to  
complemento al  
zusatz zu

**2516.510**

**2516.509**

25 Kg	02.07.2008	410-D-76A
2516.509-RVA3-1		01

○ Avec ou sans mécanique  
With or without mechanical elements  
Con o senza parti meccaniche  
Mit oder ohne Aggregate  
Con ó sin mecánica desmontada

**NISSAN**



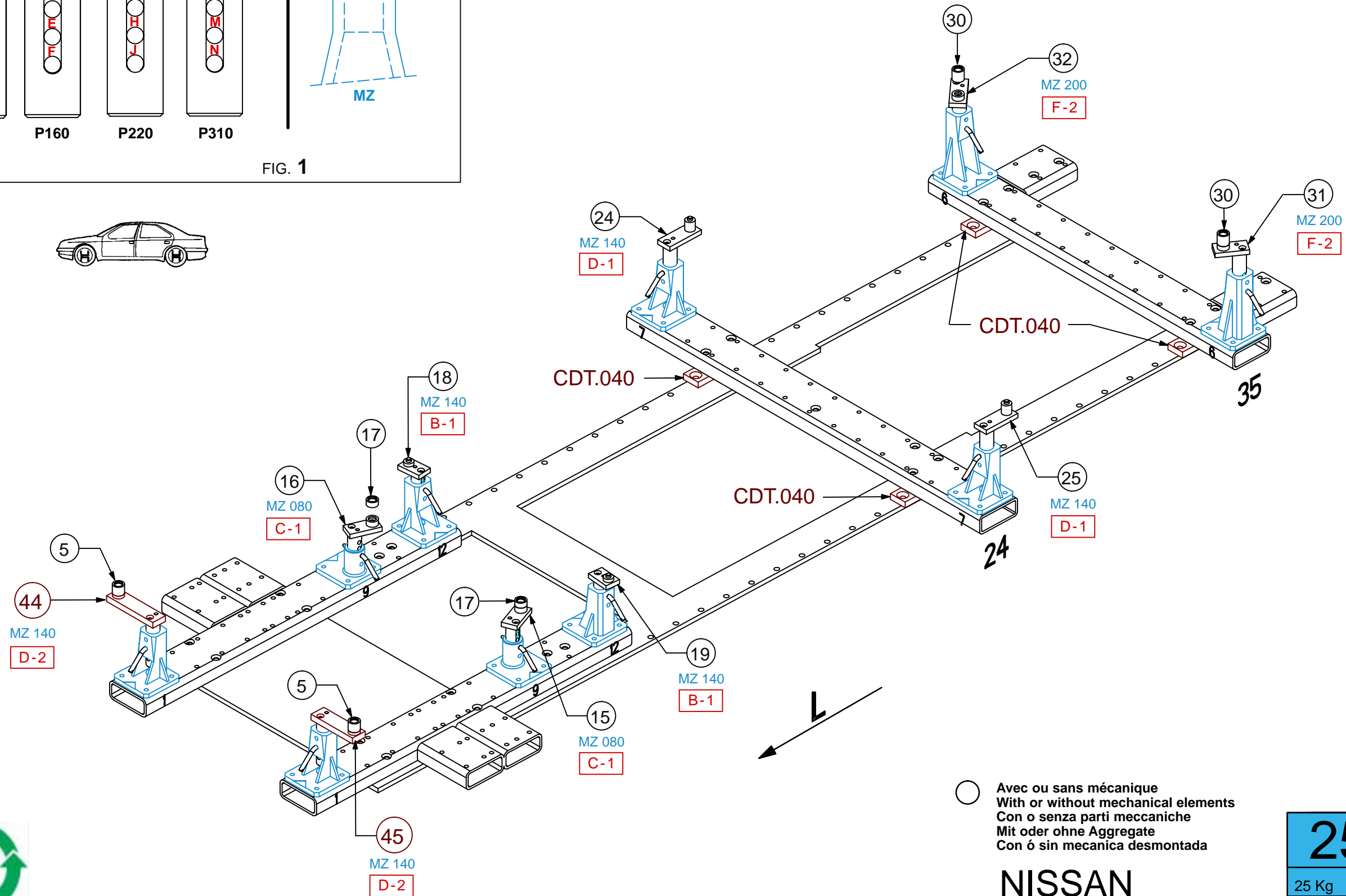
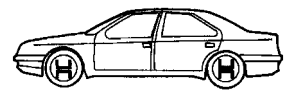
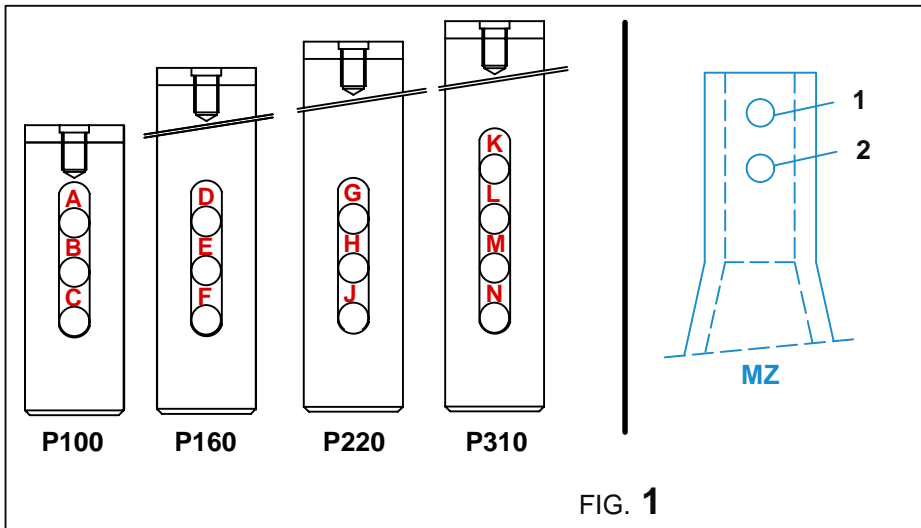

○ Avec ou sans mécanique  
 With or without mechanical elements  
 Con o senza parti meccaniche  
 Mit oder ohne Aggregate  
 Con ó sin mecánica desmontada

**NISSAN**

**2516.509**

25 Kg	02.07.2008	410-D-76B
2516.509-RVA3-1		01



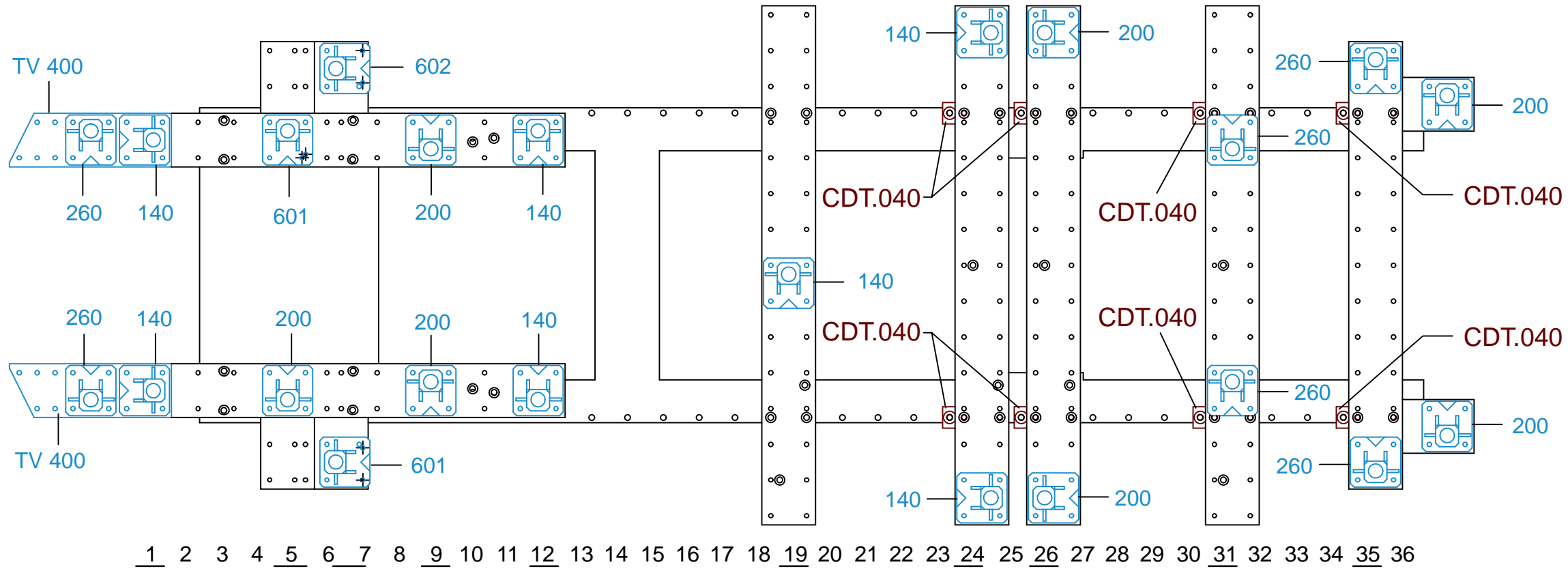

42 - 43	44 - 45	10	11	12 - 13 + 14	15 - 16	18 - 19	23 + 22	24 - 25	26 - 27	28 - 29	31 - 32	40 - 41 + 39
P310	P310	P220	P220	P220	P100	P100	P160	P160	P100	P220	P220	P220
M	M	H	J	J	C	B	F	D	A	G	G	G
1	2	1	1	1	1	1	1	1	1	1	1	1
MZ 260 + TV 400	MZ 140 + TV 400	MZ 601	MZ 200	MZ 601/602	MZ 200	MZ 140	MZ 140	MZ 140 + CDT.040	MZ 200 + CDT.040	MZ 260 + CDT.040	MZ 260 + CDT.040	MZ 200 + CDT.040
FIG. 2	FIG. 3	FIG. 5	FIG. 6	FIG. 7	FIG. 8	FIG. 9	FIG. 10	FIG. 11	FIG. 12	FIG. 13	FIG. 14	FIG. 15

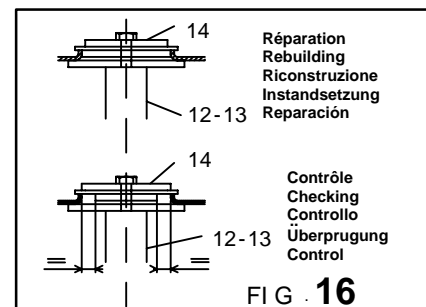
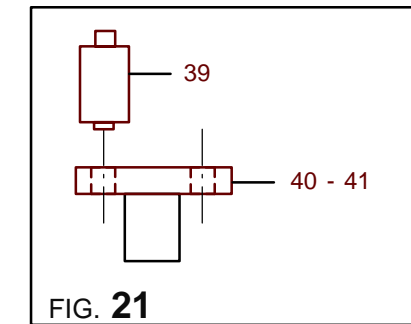

○ Avec ou sans mécanique  
With or without mechanical elements  
Con o senza parti meccaniche  
Mit oder ohne Aggregate  
Con ó sin mecánica desmontada

**NISSAN**

<b>2516.509</b>		
25 Kg	02.07.2008	410-D-76C
2516.509-RVA3-2		01



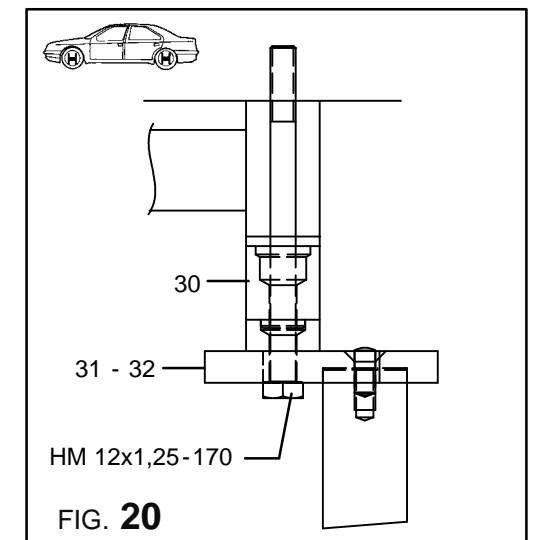
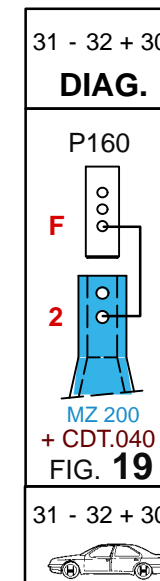
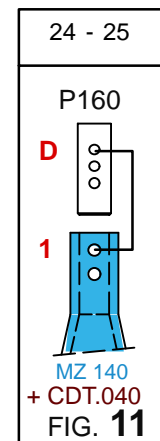
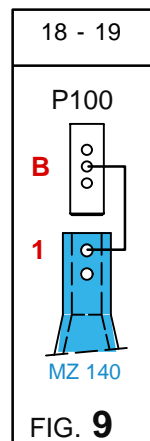
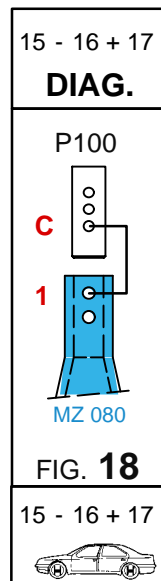
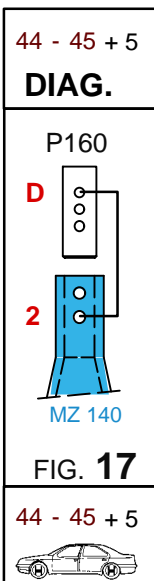
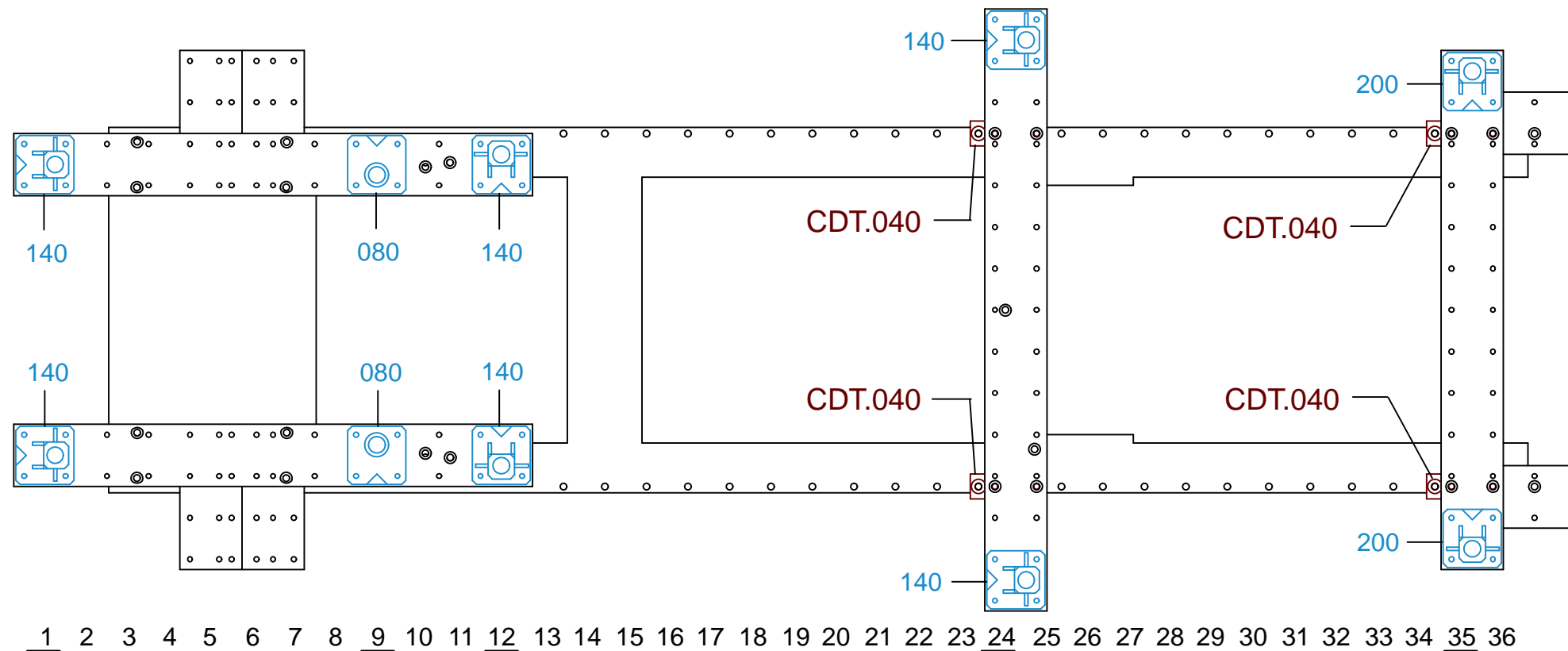
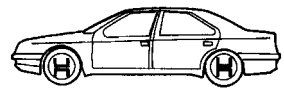

○ Avec ou sans mécanique  
With or without mechanical elements  
Con o senza parti meccaniche  
Mit oder ohne Aggregate  
Con ó sin mecanica desmontada



**NISSAN**

**2516.509**

25 Kg	02.07.2008	410-D-76D
2516.509-RVA3-2		01

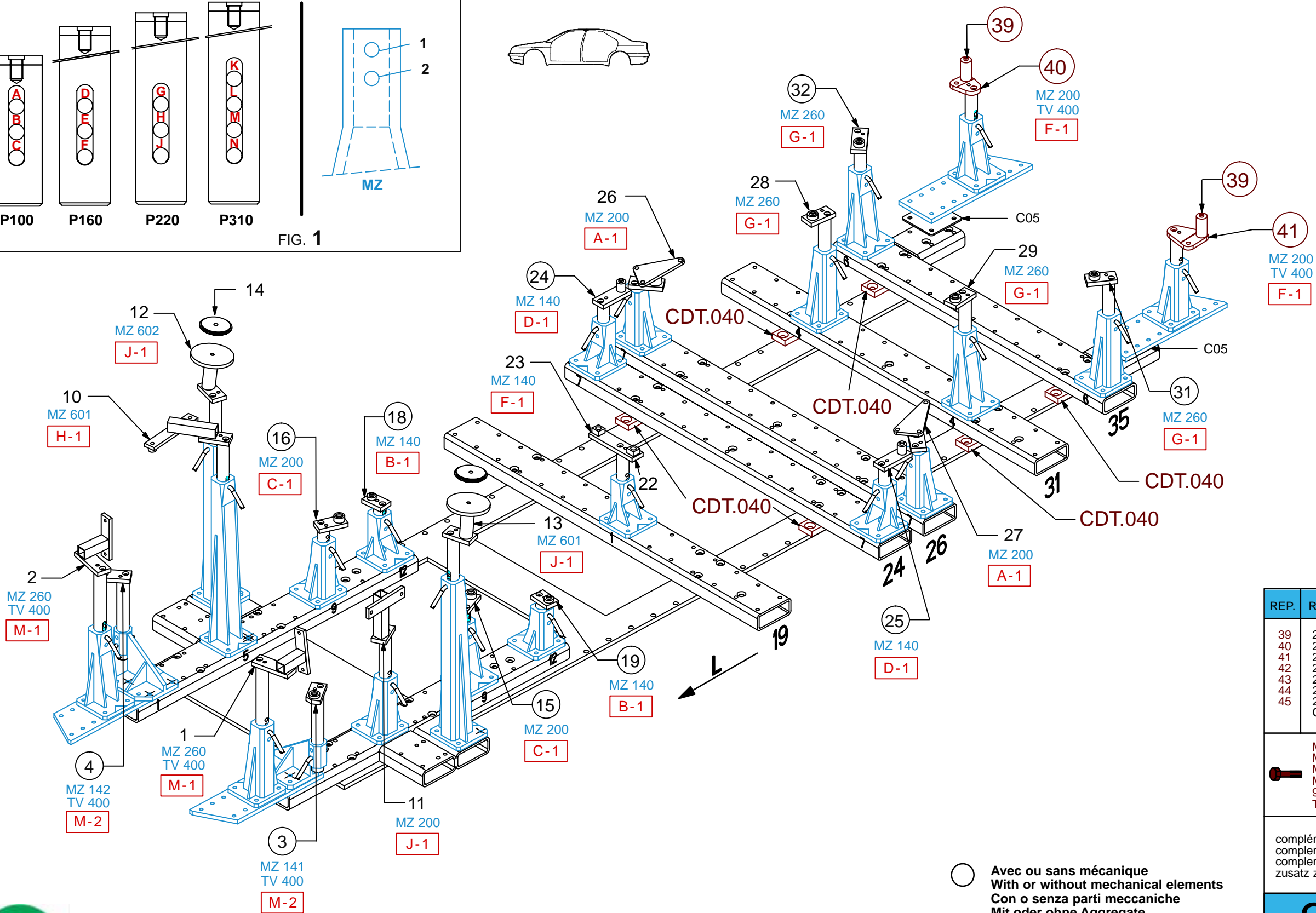
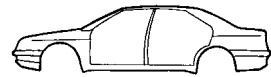
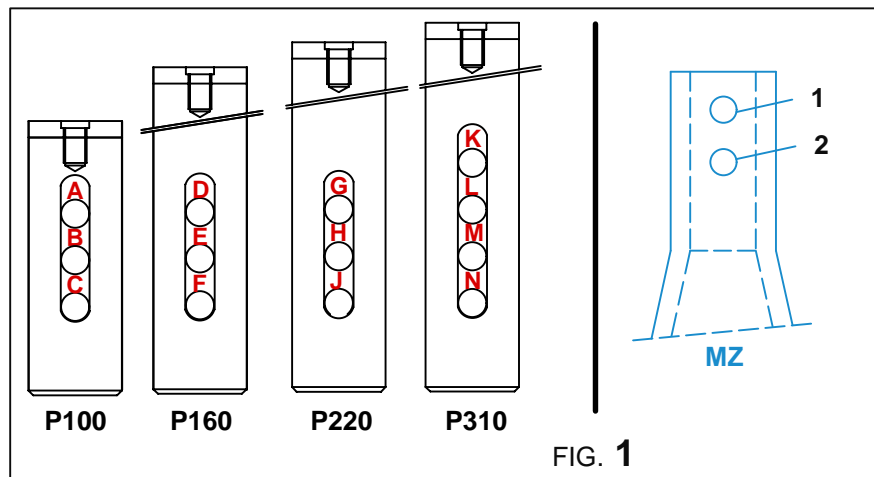

REP.	REFERENCE	PDS	NB	PISTON	MZ
39	2516.5039	0,6	2		
40	2516.5040	0,6	1	P160	200
41	2516.5041	0,9	1	P160	200
42	2516.5042	1,7	1	P310	260
43	2516.5043	1,7	1	P310	260
44	2516.5044	1,4	1	P310/160	140
45	2516.5045	1,2	1	P310/160	140
	CDT.040	1,5	8		

M 8-25	4
M 10-25	2
M 12x1,25-50	2
M 12x1,25-220	2
955714	16
TFhc 16-60	16

complément au  
complementary set to  
complemento al  
zusatz zu **2516.510**

**2516.509**

25 Kg	02.07.2008	410-D-76E
2516.509-RVA3-3		01

○ Avec ou sans mécanique  
With or without mechanical elements  
Con o senza parti meccaniche  
Mit oder ohne Aggregate  
Con ó sin mecánica desmontada

**NISSAN**



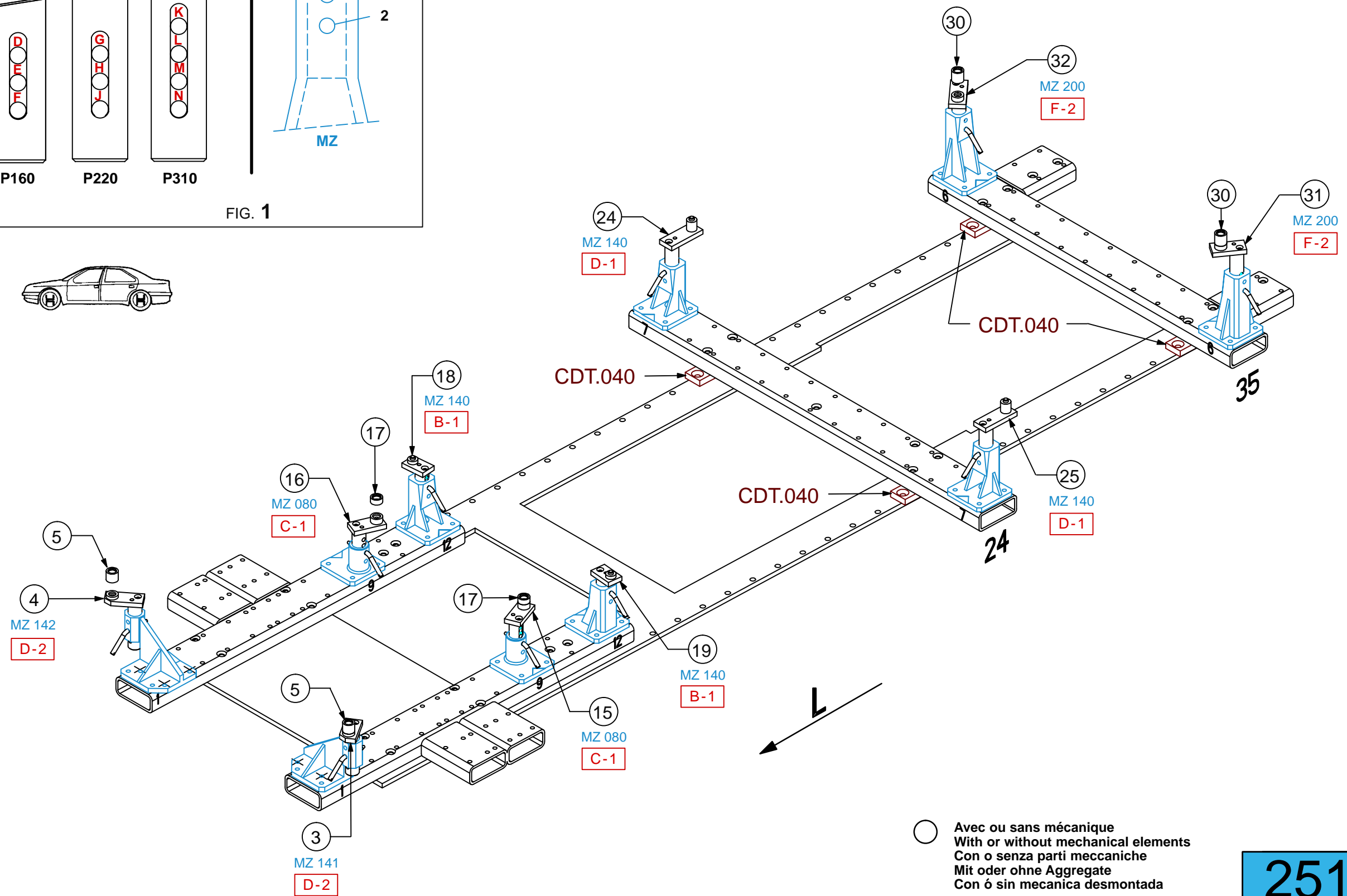
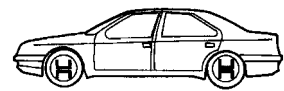
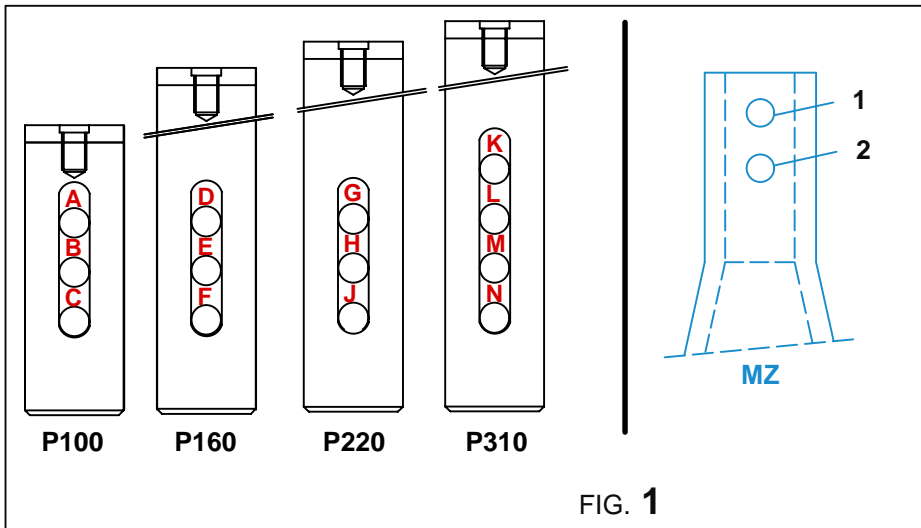

○ Avec ou sans mécanique  
 With or without mechanical elements  
 Con o senza parti meccaniche  
 Mit oder ohne Aggregate  
 Con ó sin mecánica desmontada



**NISSAN**

<b>2516.509</b>		
25 Kg	02.07.2008	410-D-76F
2516.509-RVA3-3		01



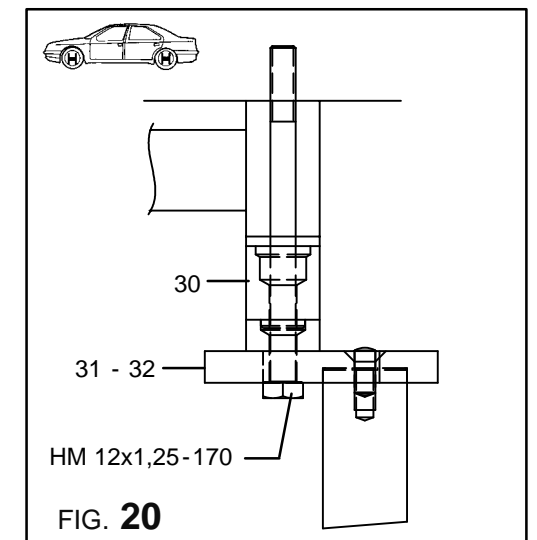
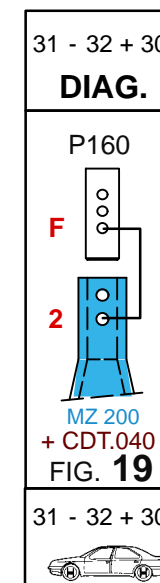
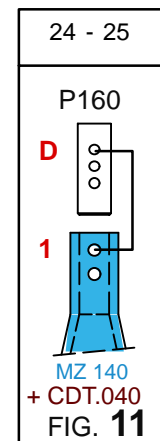
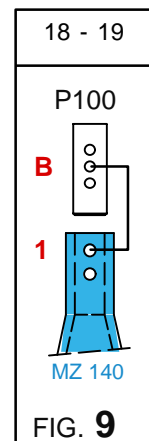
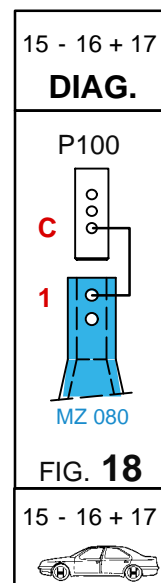
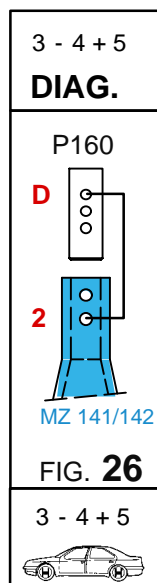
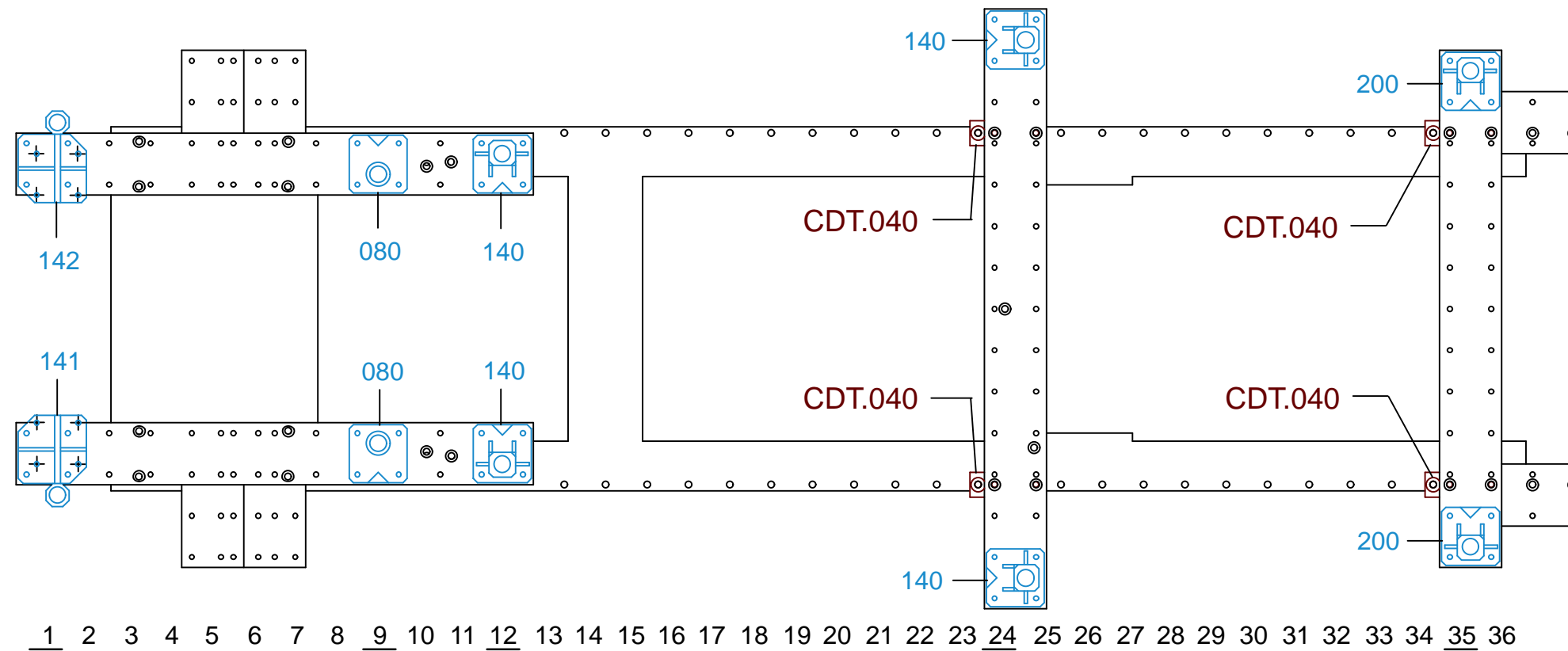
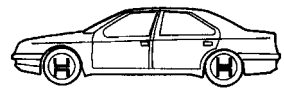

○ Avec ou sans mécanique  
With or without mechanical elements  
Con o senza parti meccaniche  
Mit oder ohne Aggregate  
Con ó sin mecanica desmontada



**NISSAN**

**2516.509**

25 Kg	02.07.2008	410-D-76H
2516.509-RVA3-4		01