

REP.	REFERENCE	PDS	NB	PISTON	MZ
1	2514.5001	1,3	1	P220	141
2	2514.5002	1,3	1	P220	142
3	2514.5003	1,4	1	P100/160	260
4	2514.5004	1,4	1	P100/160	260
5	2514.5005	1,0	1	P160	601
6	2514.5006	1,0	1	P160	602
7	2514.5007	0,2	2		
8	2514.5008	0,5	1	P220/100	260/080
9	2514.5009	0,5	1	P220/100	260/080
10	2514.5010	0,8	2		
11	2514.5011	0,6	1	P100	080
12	2514.5012	0,6	1	P100	080
13	2514.5013	0,1	2		
14	2514.5014	0,5	1	P100	080
15	2514.5015	0,5	1	P100	080
16	2514.5016	0,6	1	P100	140
17	2514.5017	0,6	1	P100	140
18	2514.5018	1,1	1	P100	140
19	2514.5019	1,1	1	P100	140
20	2514.5020	0,6	1	P100	602
21	2514.5021	0,6	1	P100	601
22	2514.5022	0,05	2		
23	2514.5023	0,5	1	P220	200
24	2514.5024	0,5	1	P220	200
	B55	0,2	2		
A	MZ2500.CR500B	6,5	1		
B	MR.2505.500	0,2	1		

M 8-35	4
M 12-25	4
M 14-25	2
M 14x1,50-40	2
M 14x1,50-60	2
M 14x1,50-100	2

○ Avec ou sans mécanique
With or without mechanical elements
Con o senza parti meccaniche
Mit oder ohne Aggregate
Con ó sin mecanica desmontada

2514.500

OPEL / SUZUKI

26 Kg	05.02.2008	422-D-31A
2514.500-RVA3-1		00



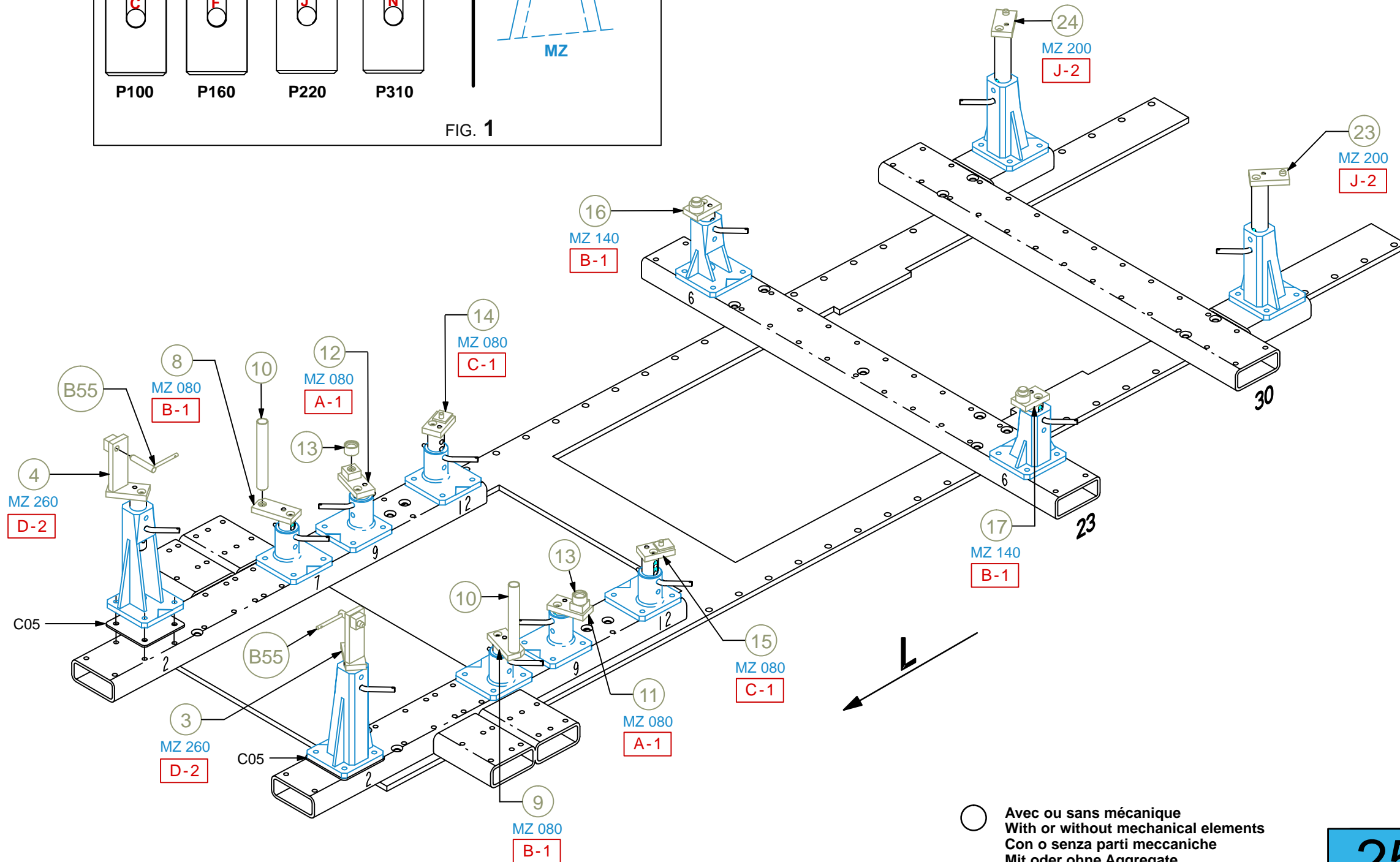
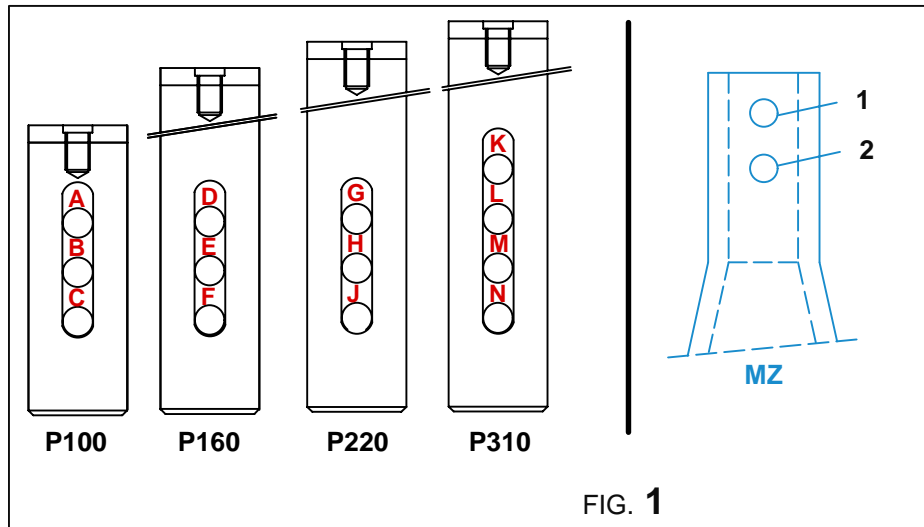
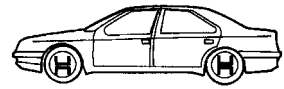

○ Avec ou sans mécanique
 With or without mechanical elements
 Con o senza parti meccaniche
 Mit oder ohne Aggregate
 Con ó sin mecanica desmontada



OPEL / SUZUKI

2514.500		
26 Kg	05.02.2008	422-D-31B
2514.500-RVA3-1		00

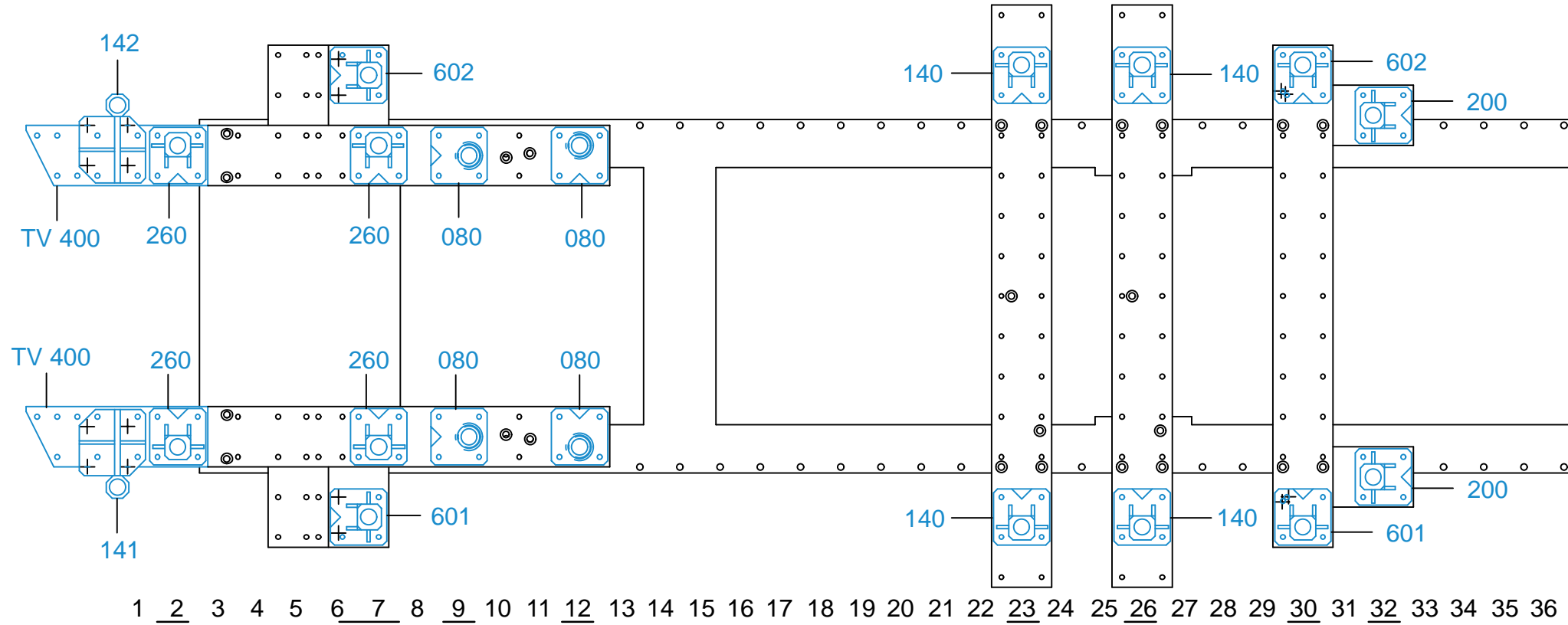
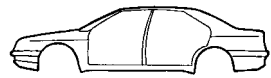

1 - 2	3 - 4 + B55	5 - 6 + 7	8 - 9	11 - 12	14 - 15
P220	P100	P160	P220	P100	P100
G	B	E	G	C	C
1	1	1	2	1	1
MZ 141/142 + TV 400	MZ 260 + TV 400	MZ 601 / 602	MZ 260	MZ 080	MZ 080
FIG. 2	FIG. 3	FIG. 4	FIG. 5	FIG. 6	FIG. 7

16 - 17	18 - 19	20 - 21 + 22	23 - 24
P100	P100	P100	P220
B	A	A	J
1	1	1	2
MZ 140	MZ 140	MZ 601 / 602	MZ 200
FIG. 8	FIG. 9	FIG. 10	FIG. 11

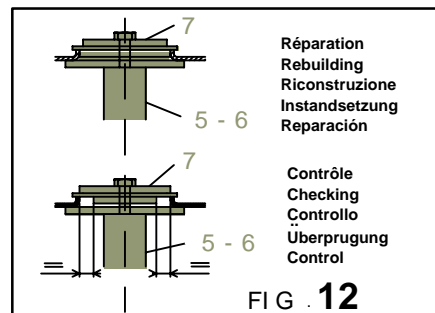

○ Avec ou sans mécanique
With or without mechanical elements
Con o senza parti meccaniche
Mit oder ohne Aggregate
Con ó sin mecanica desmontada

OPEL / SUZUKI

2514.500		
26 Kg	05.02.2008	422-D-31C
2514.500-RVA3-2		00



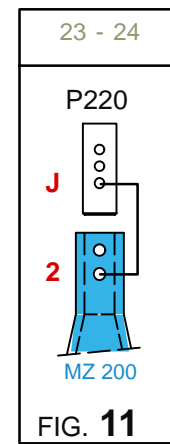
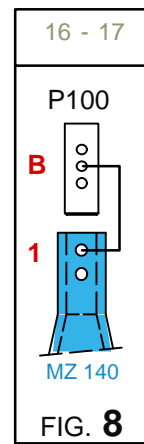
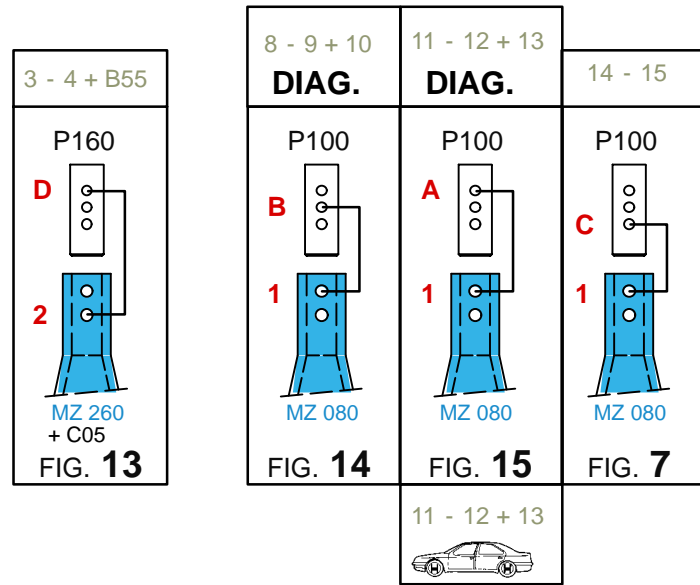
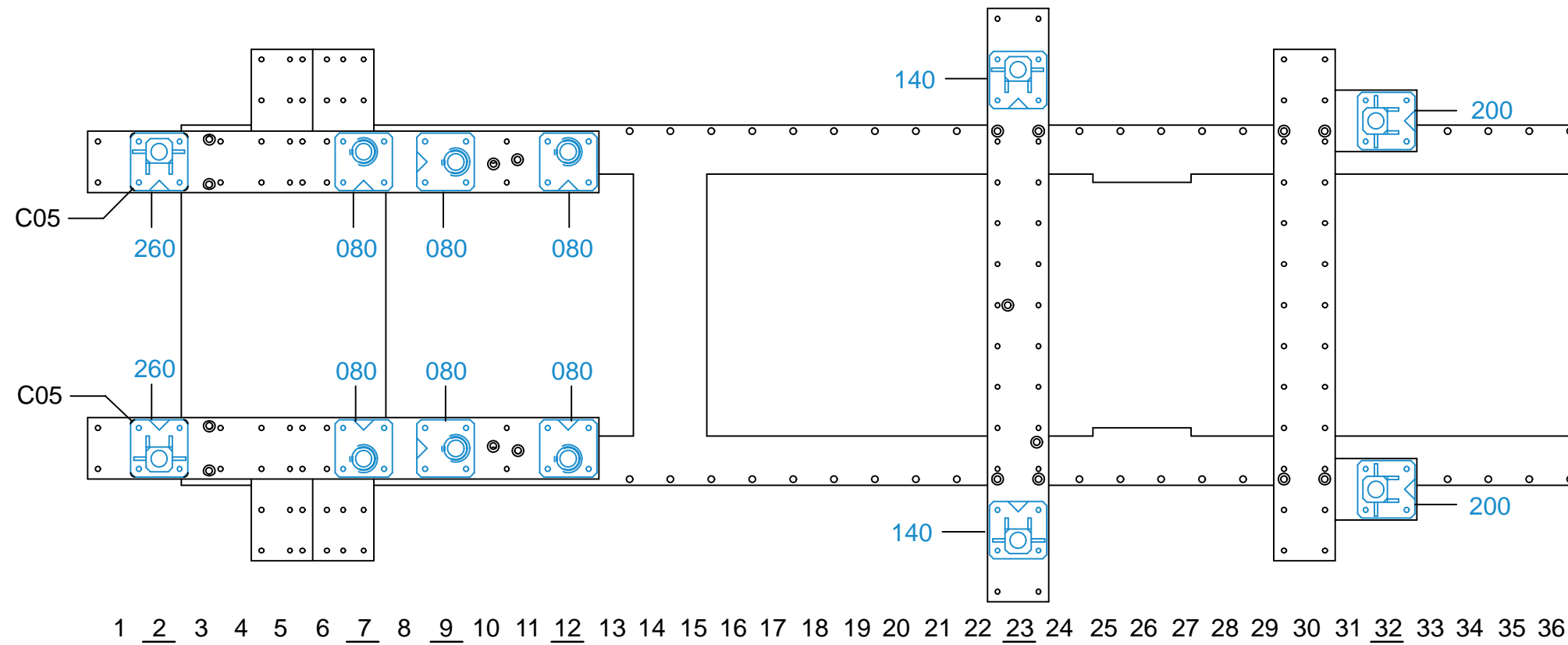
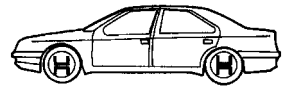

○ Avec ou sans mécanique
With or without mechanical elements
Con o senza parti meccaniche
Mit oder ohne Aggregate
Con ó sin mecanica desmontada

OPEL / SUZUKI

2514.500		
26 Kg	05.02.2008	422-D-31D
2514.500-RVA3-2		00

