

○ Avec ou sans mécanique
 With or without mechanical elements
 Con o senza parti meccaniche
 Mit oder ohne Aggregate
 Con ó sin mecanica desmontada

REP.	REFERENCE	PDS	NB	PISTON	MZ
	CDT.040	1,5	6		

	955714 TFHc M 16-60		12 12		
--	------------------------	--	----------	--	--

complément au
 complementary set to
 complemento al
 zusatz zu **2505.500**

2505.509

11 Kg	30.09.2008	427-D-34E
2505.509-RVA3-1		00



RENAULT

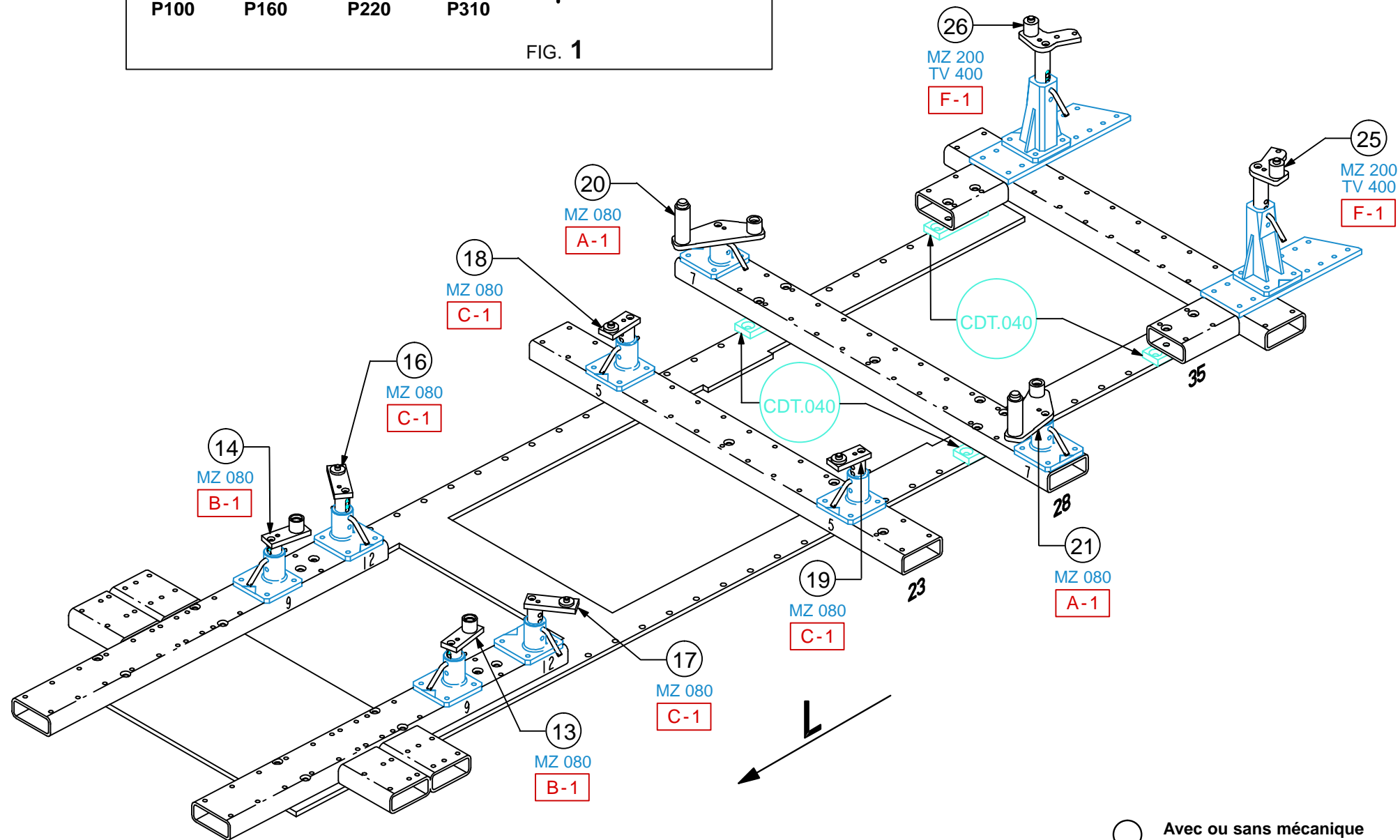
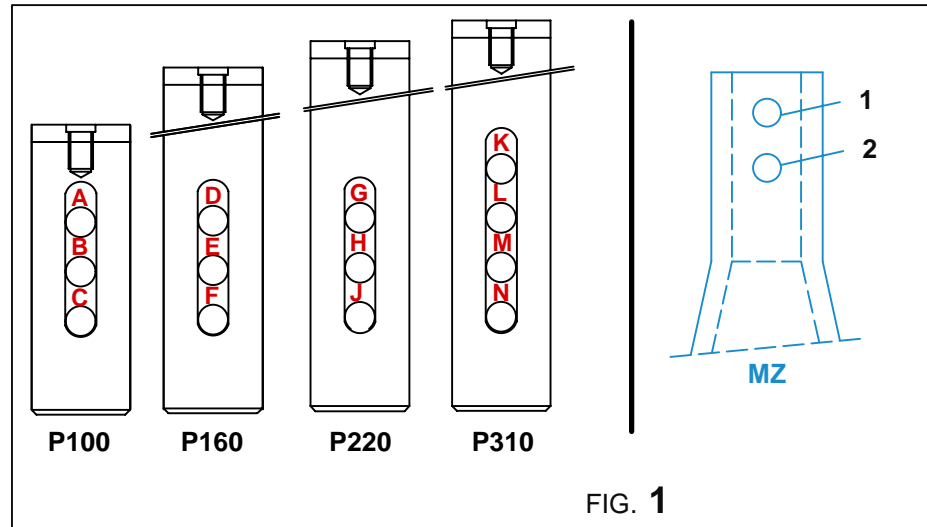
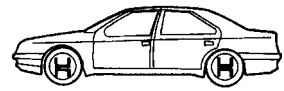

○ Avec ou sans mécanique
 With or without mechanical elements
 Con o senza parti meccaniche
 Mit oder ohne Aggregate
 Con ó sin mecanica desmontada

RENAULT

2505.509

11 Kg	30.09.2008	427-D-34F
2505.509-RVA3-1		00



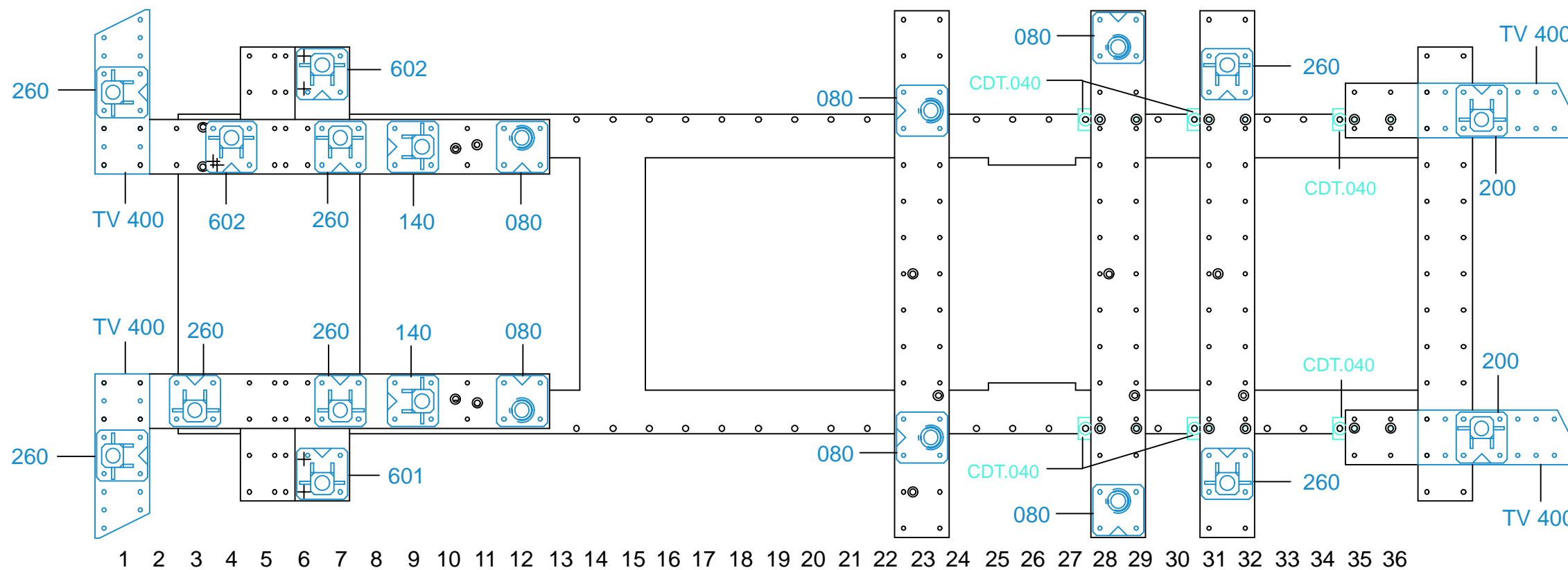

1 - 2 + 5	6	7	8 - 9 + 10	11 - 12	13 - 14 + 15	16 - 17
P220 H	P160 E	P160 F	P310 K	P160 F	P100 B	P100 C
MZ 260 + TV 400	MZ 602	MZ 260	MZ 601 / 602	MZ 260	MZ 140	MZ 080
FIG. 2	FIG. 3	FIG. 4	FIG. 5	FIG. 6	FIG. 7	FIG. 8

18 - 19	20 - 21 + 22	23 - 24	25 - 26
P100 C	P100 A	P310 M	P160 F
MZ 080	MZ 080 + CDT.040	MZ 260 + CDT.040	MZ 200 + TV 400 + CDT.040
FIG. 9	FIG. 10	FIG. 11	FIG. 12

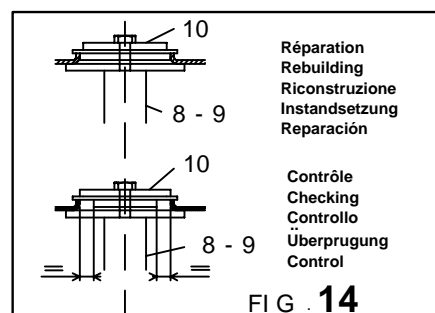

○ Avec ou sans mécanique
With or without mechanical elements
Con o senza parti meccaniche
Mit oder ohne Aggregate
Con ó sin mecanica desmontada

RENAULT

2505.509

11 Kg | 30.09.2008 | 427-D-34G
2505.509-RVA3-2 | 00

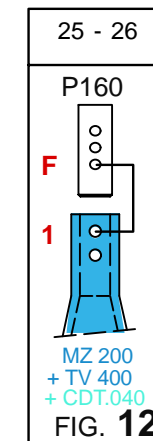
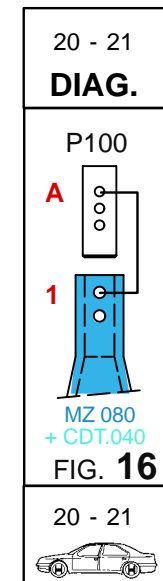
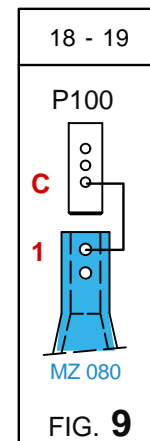
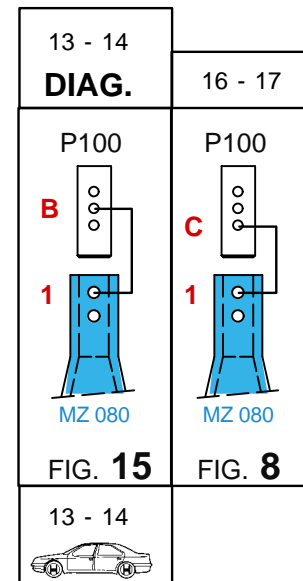
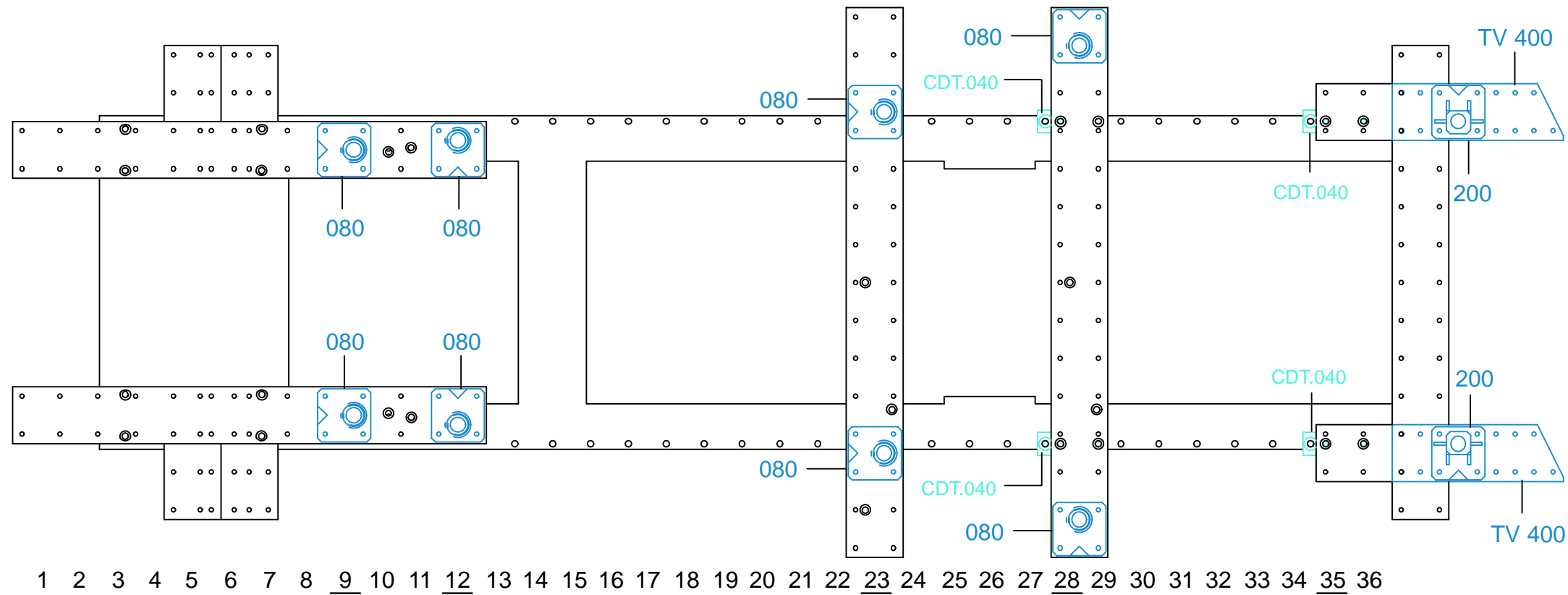
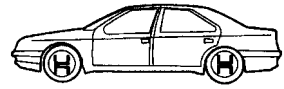

○ Avec ou sans mécanique
With or without mechanical elements
Con o senza parti meccaniche
Mit oder ohne Aggregate
Con ó sin mecanica desmontada



RENAULT

2505.509		
11 Kg	30.09.2008	427-D-34H
2505.509-RVA3-2		00