

○ Avec ou sans mécanique
 With or without mechanical elements
 Con o senza parti meccaniche
 Mit oder ohne Aggregate
 Con ó sin mecanica desmontada

REP.	REFERENCE	PDS	NB	PISTON	MZ
1	2503.5001	1,3	1	P220	200
2	2503.5002	1,3	1	P220	200
3	2503.5003	0,9	1	P160	200
4	2503.5004	0,9	1	P160	200
5	2503.5005	0,6	1	P100	260/080
6	2503.5006	0,6	1	P100	260/080
7	2503.5007	0,1	2		
8	2503.5008	0,5	2		
9	2503.5009	2,3	1	P100	601
10	2503.5010	2,3	1	P100	602
11	2503.5011	0,2	2		
12	2503.5012	2,4	1		
13	2503.5013	2,4	1		
14	2503.5014	0,9	1	P100	080
15	2503.5015	0,9	1	P100	080
16	2503.5016	0,05	2		
17	2503.5017	0,1	2		
18	2503.5018	0,2	2		
19	2503.5019	0,6	1	P100	080
20	2503.5020	0,6	1	P100	080
21	2503.5021	0,8	1	P160/100	140/080
22	2503.5022	0,8	1	P160/100	140/080
23	2503.5023	0,05	2		
24	2503.5024	0,05	4		
25	2503.5025	0,2	4		
26	2503.5026	0,9	1	P310	602
27	2503.5027	0,9	1	P310	601
28	2503.5028	0,8	1	P160	200/140
29	2503.5029	0,8	1	P160	200/140
30	2503.5030	0,1	2		
31	2503.5031	0,8	1	P160	260
32	2503.5032	0,8	1	P160	260
A	MZ2500.CR500B	6,5	1		
B	MR.2506.500	0,2	1		

M 8-40	2
M 12-30	4
M 12-35	4
M 10x1,25-70	4
M 8	6
M 14x1,50	2
MU 12	2
MU 14	2

2503.500

36 Kg 04.10.2007 410-D-75A
 2503.500-RVA3-1 00



NISSAN

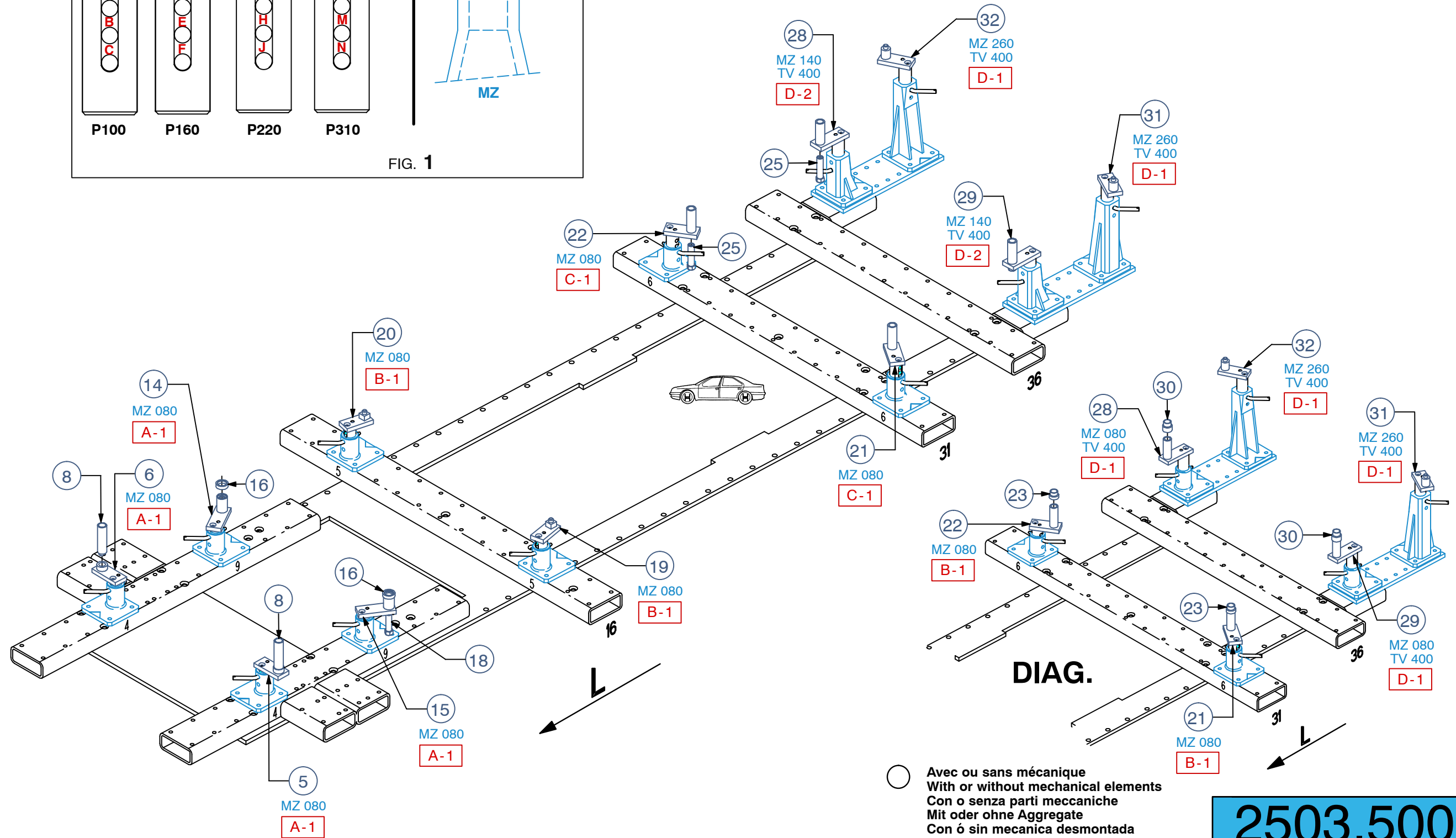
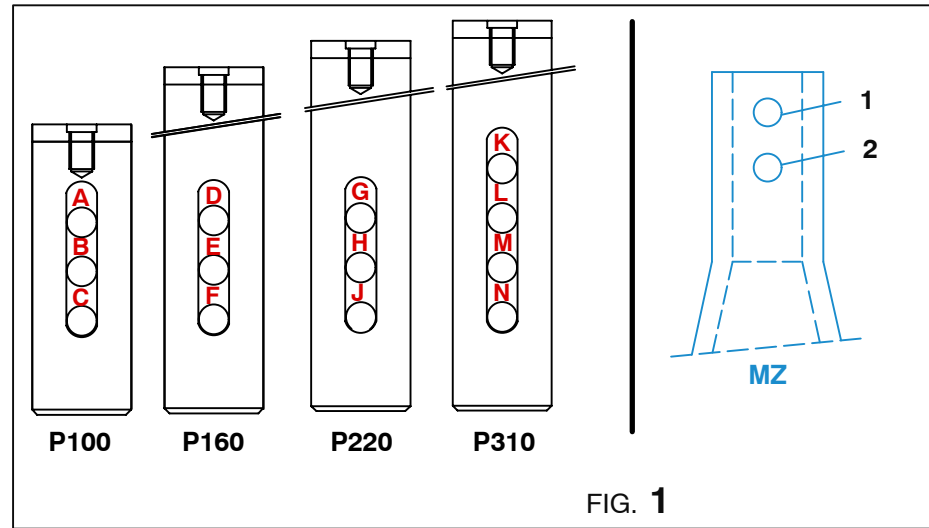
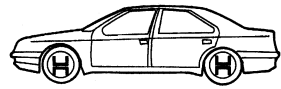

○ Avec ou sans mécanique
 With or without mechanical elements
 Con o senza parti meccaniche
 Mit oder ohne Aggregate
 Con ó sin mecánica desmontada



NISSAN

2503.500		
36 Kg	04.10.2007	410-D-75B
2503.500-RVA3-1		00

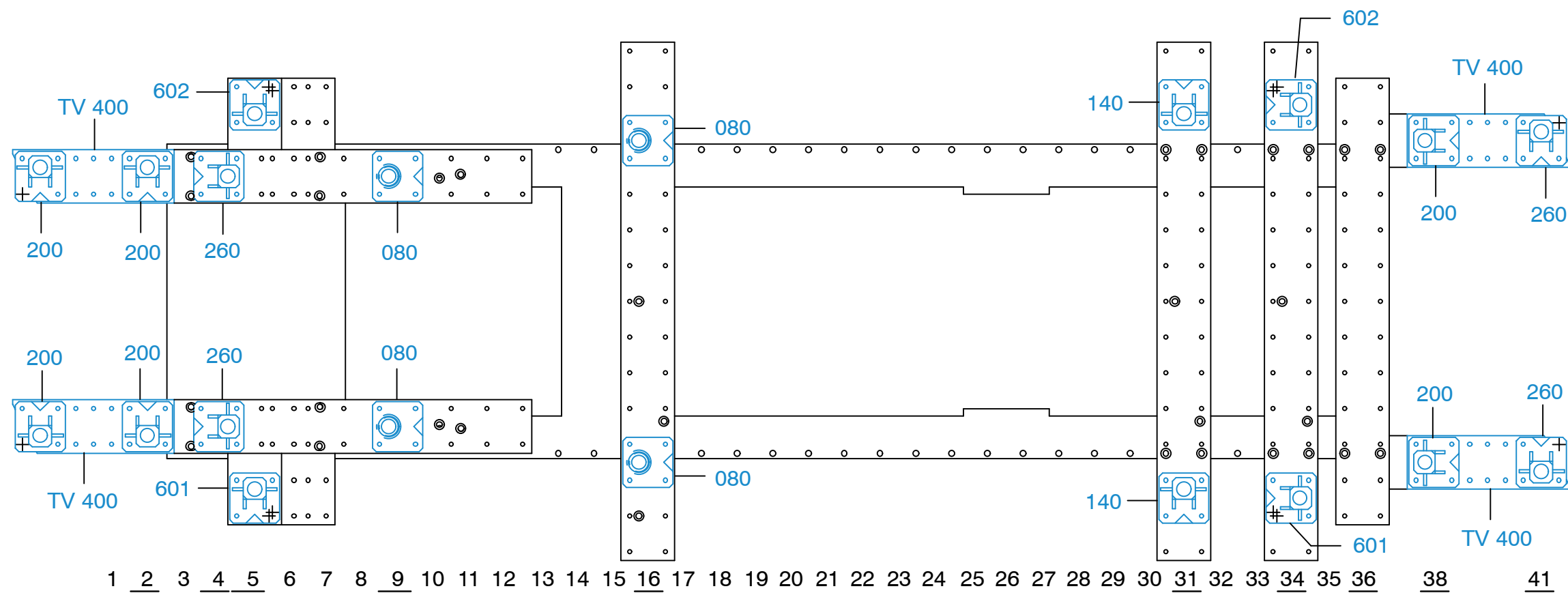

1 - 2	3 - 4	5 - 6 + 7	9 - 10 + 11	14 - 15 + 17	19 - 20
P220 G 1	P160 D 1	P160 F 2	P100 A 1	P100 A 1	P100 B 1
MZ 200 + TV 400	MZ 200 + TV 400 Ou/Or/ Oder/O	MZ 200 + C05	MZ 260	MZ 601 / 602	MZ 080
FIG. 2	FIG. 3	FIG. 4	FIG. 5	FIG. 6	FIG. 7

21 - 22 + 24	26 - 27	28 - 29 + 24	31 - 32
P160 F 2	P310 L 1	P160 D 1	P160 D 1
MZ 140	MZ 601 / 602	MZ 200 + TV 400 Ou/Or/ Oder/O	MZ 200 + C05 Ou/Or/ Oder/O
FIG. 8	FIG. 9	FIG. 10	FIG. 11

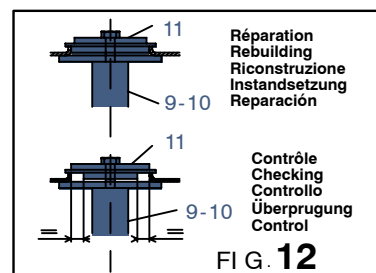

○ Avec ou sans mécanique
With or without mechanical elements
Con o senza parti meccaniche
Mit oder ohne Aggregate
Con ó sin mecanica desmontada

NISSAN

2503.500		
36 Kg	04.10.2007	410-D-75C
2503.500-RVA3-2		00

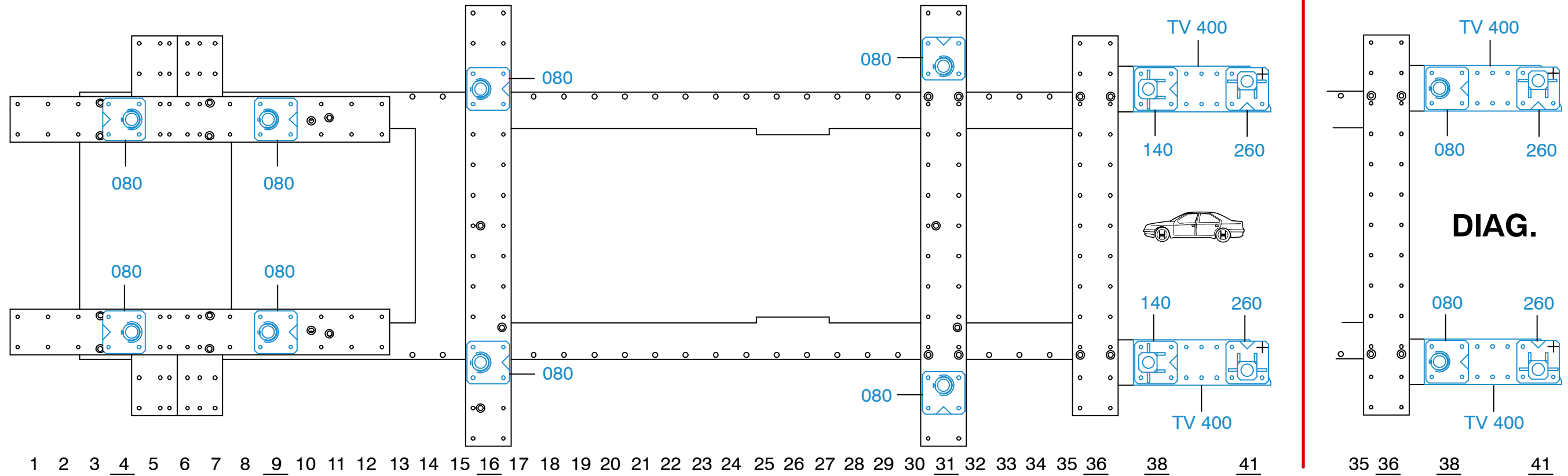
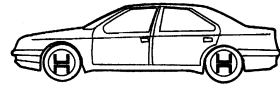

1 2 3 4 5 6 7 8 9 10 11 12 13 14 15 16 17 18 19 20 21 22 23 24 25 26 27 28 29 30 31 32 33 34 35 36 38 41 35 36 38 41

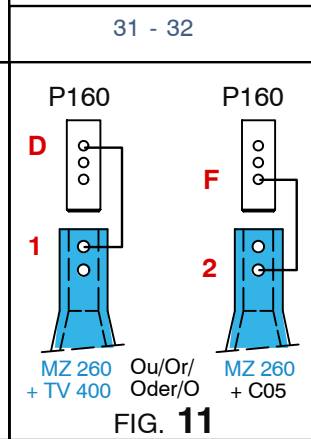
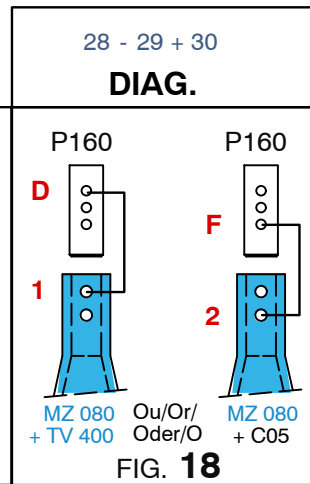
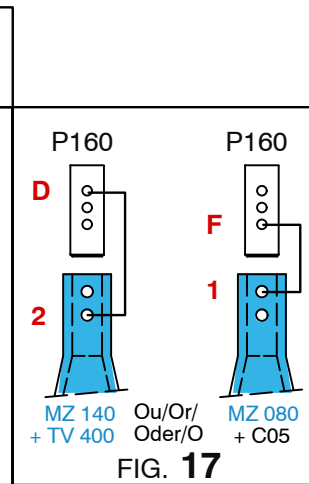
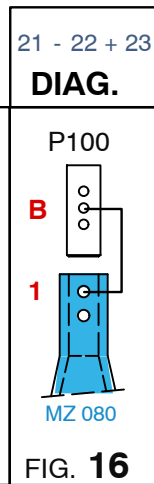
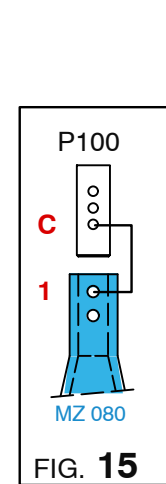
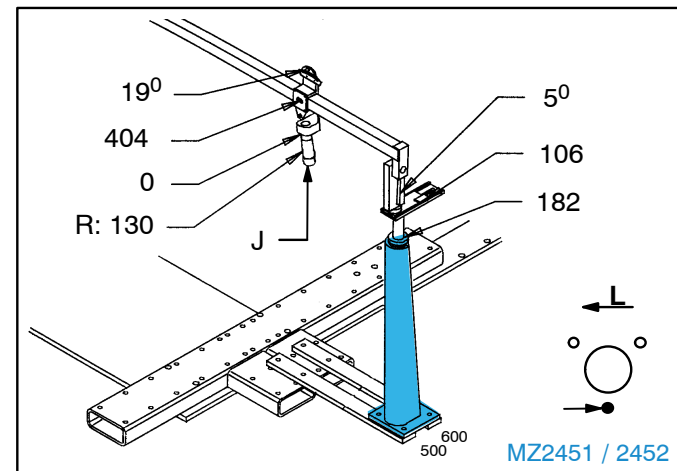
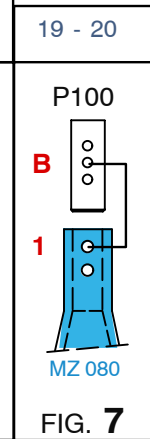
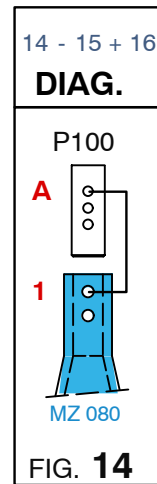
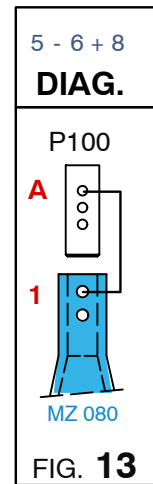

○ Avec ou sans mécanique
With or without mechanical elements
Con o senza parti meccaniche
Mit oder ohne Aggregate
Con ó sin mecanica desmontada



NISSAN

2503.500

36 Kg | 04.10.2007 | 410-D-75D
2503.500-RVA3-2 | 00