

○ Avec ou sans mécanique
 With or without mechanical elements
 Con o senza parti meccaniche
 Mit oder ohne Aggregate
 Con ó sin mecánica desmontada

REP.	REFERENCE	PDS	NB	PISTON	MZ
1	2501.5001	0,4	1	P310	200
2	2501.5002	0,4	1	P310	200
3	2501.5003	1,3	1	P100	140
4	2501.5004	1,4	1	P100	140
5	2501.5005	0,1	2		
6	2501.5006	1,4	1	P160	602
7	2501.5007	0,7	1	P220	601
8	2501.5008	0,7	1	P220	602
9	2501.5009	0,1	2		
10	2501.5010	0,7	1	P100	142
11	2501.5011	0,7	1	P100	141
12	2501.5012	0,1	2		
13	2501.5013	0,2	2		
14	2501.5014	0,2	2		
15	2501.5015	0,7	1	P100	080
16	2501.5016	0,9	1	P100	080
17	2501.5017	0,7	1	P160/100	200/140
18	2501.5018	0,7	1	P160/100	200/140
19	2501.5019	0,5	2		
20	2501.5020	0,8	1	P310	260
21	2501.5021	0,8	1	P310	260
22	2501.5022	0,02	2		
23	2501.5023	0,4	1	P100	260
24	2501.5024	0,4	1	P100	260
25	2501.5025	1,0	1		

M 6-30	2
M 10-45	2
M 10-140	2
M 12-25	2
M 12-30	2
M 10x1,25-25	2
M 10x1,25	2
LU 10	2

2501.500

17 Kg 03.04.2007 427-D-33A

2501.500-RVA3-1 00

RENAULT

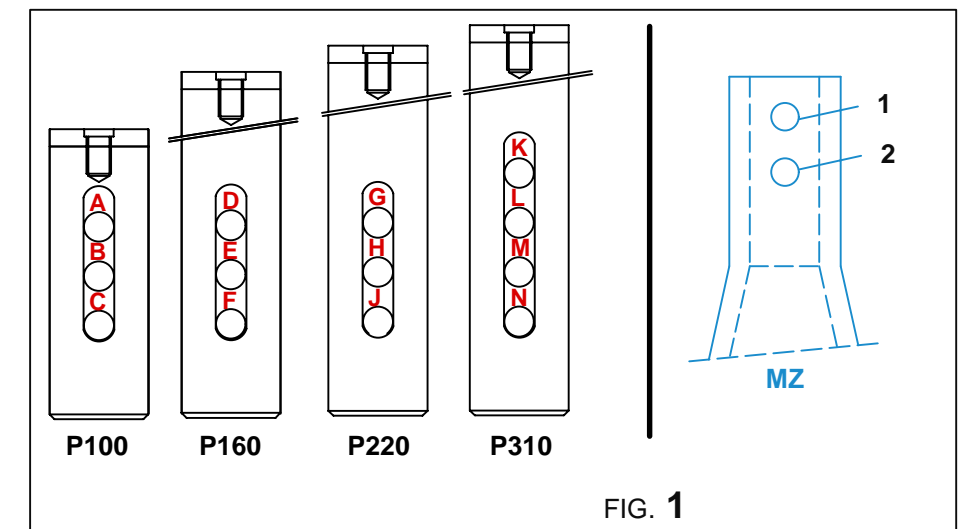
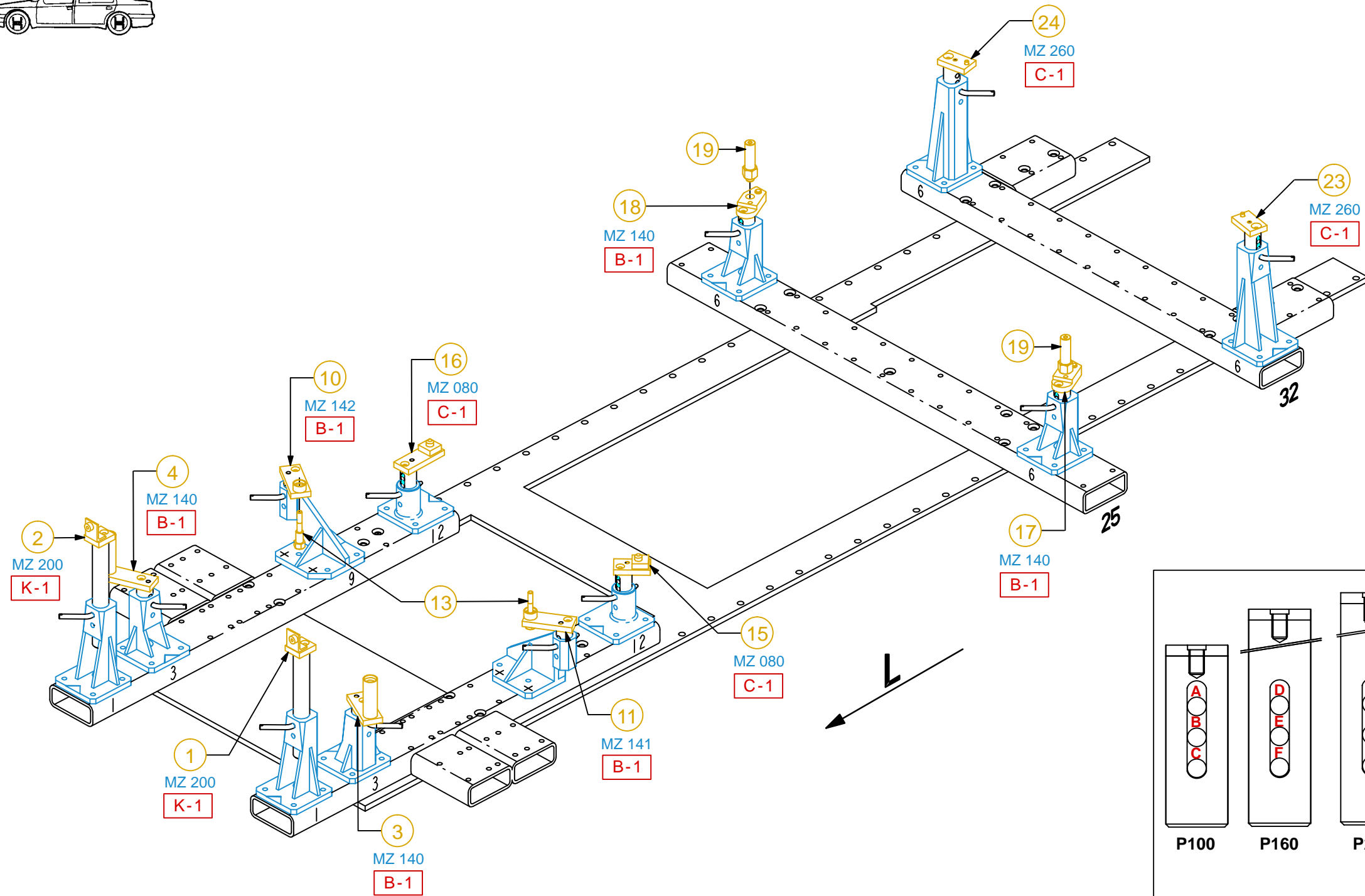

○ Avec ou sans mécanique
 With or without mechanical elements
 Con o senza parti meccaniche
 Mit oder ohne Aggregate
 Con ó sin mecánica desmontada

RENAULT

2501.500		
17 Kg	03.04.2007	427-D-33B
2501.500-RVA3-1		00

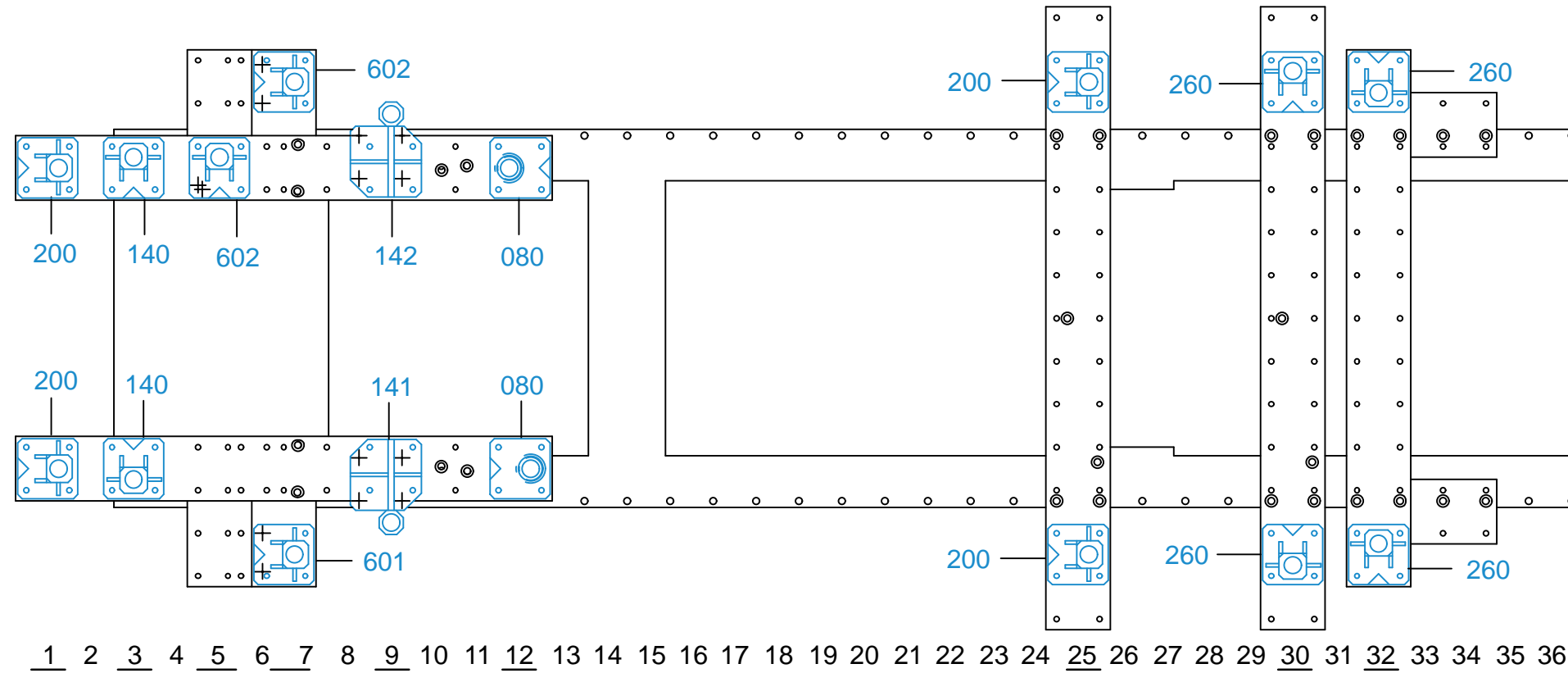

1 - 2	3 - 4 + 5	6	7 - 8 + 9	10 - 11 + 12 + 14	15 - 16
P310 K	P100 B	P160 E	P220 G	P100 C	P100 C
1	1	1	1	1	1
MZ 200	MZ 140	MZ 602	MZ 601 / 602	MZ 141 / 142	MZ 080
FIG. 2	FIG. 3	FIG. 4	FIG. 5	FIG. 6	FIG. 7

17 - 18	20 - 21 + 22	23 - 24
P160 D	P310 N	P100 C
1	1	1
MZ 200	MZ 260	MZ 260
FIG. 8	FIG. 9	FIG. 10

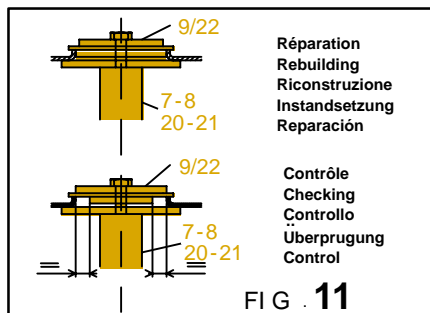

○ Avec ou sans mécanique
With or without mechanical elements
Con o senza parti meccaniche
Mit oder ohne Aggregate
Con ó sin mecanica desmontada

RENAULT

2501.500		
17 Kg	03.04.2007	427-D-33C
2501.500-RVA3-2		00

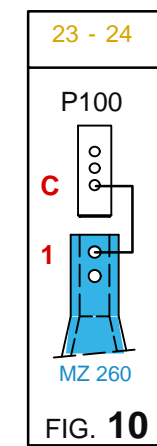
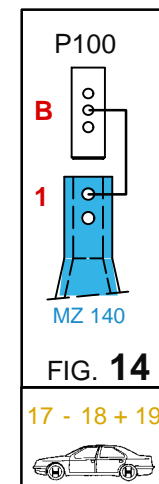
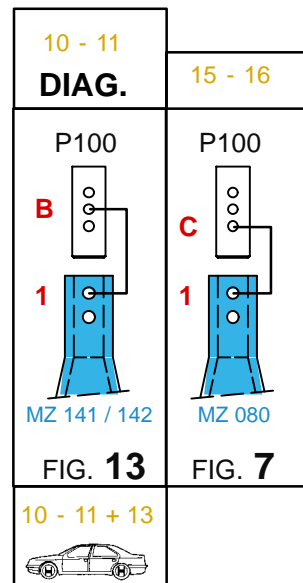
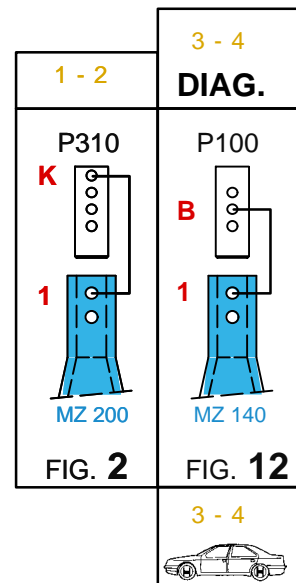
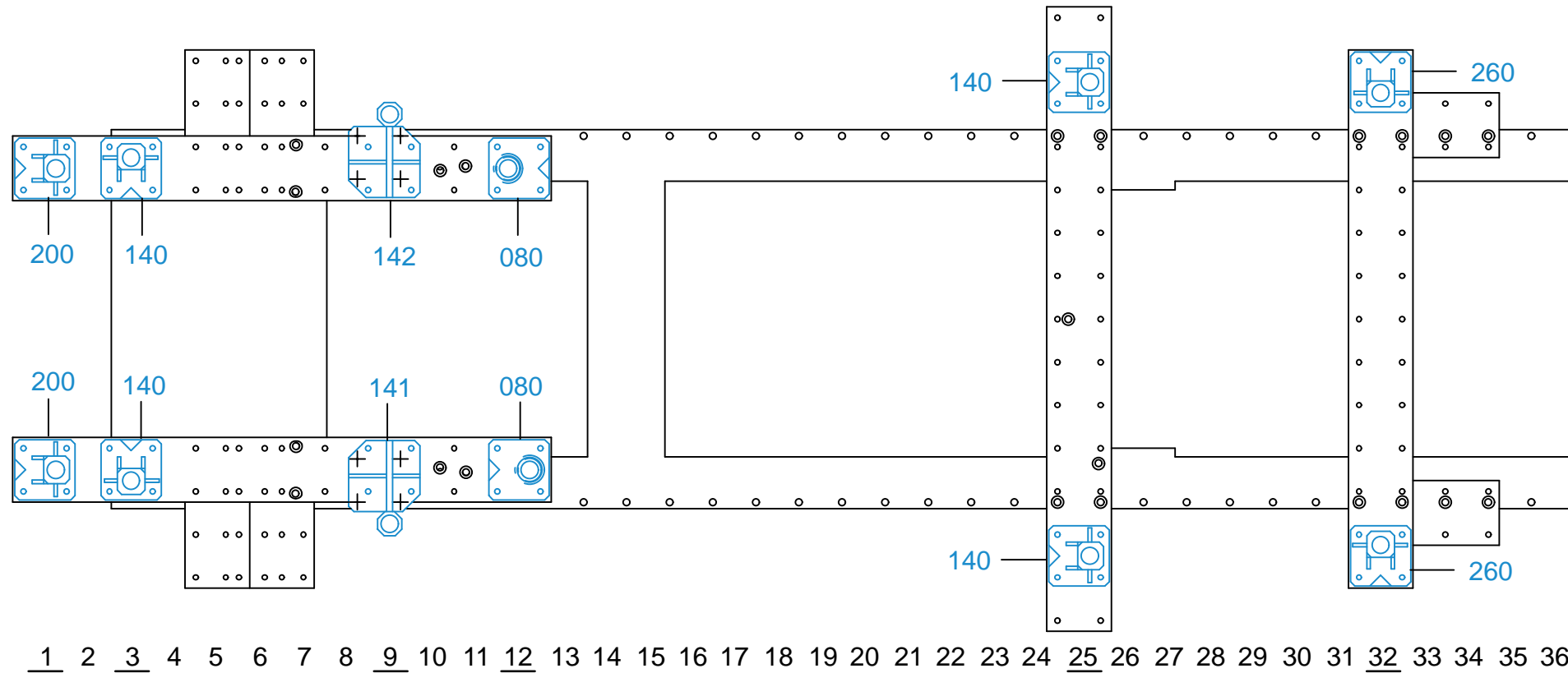
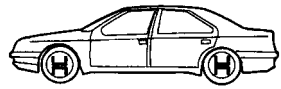

○ Avec ou sans mécanique
With or without mechanical elements
Con o senza parti meccaniche
Mit oder ohne Aggregate
Con ó sin mecanica desmontada

RENAULT

2501.500		
17 Kg	03.04.2007	427-D-33D
2501.500-RVA3-2		00