

**M8S  
MT10  
SVN**

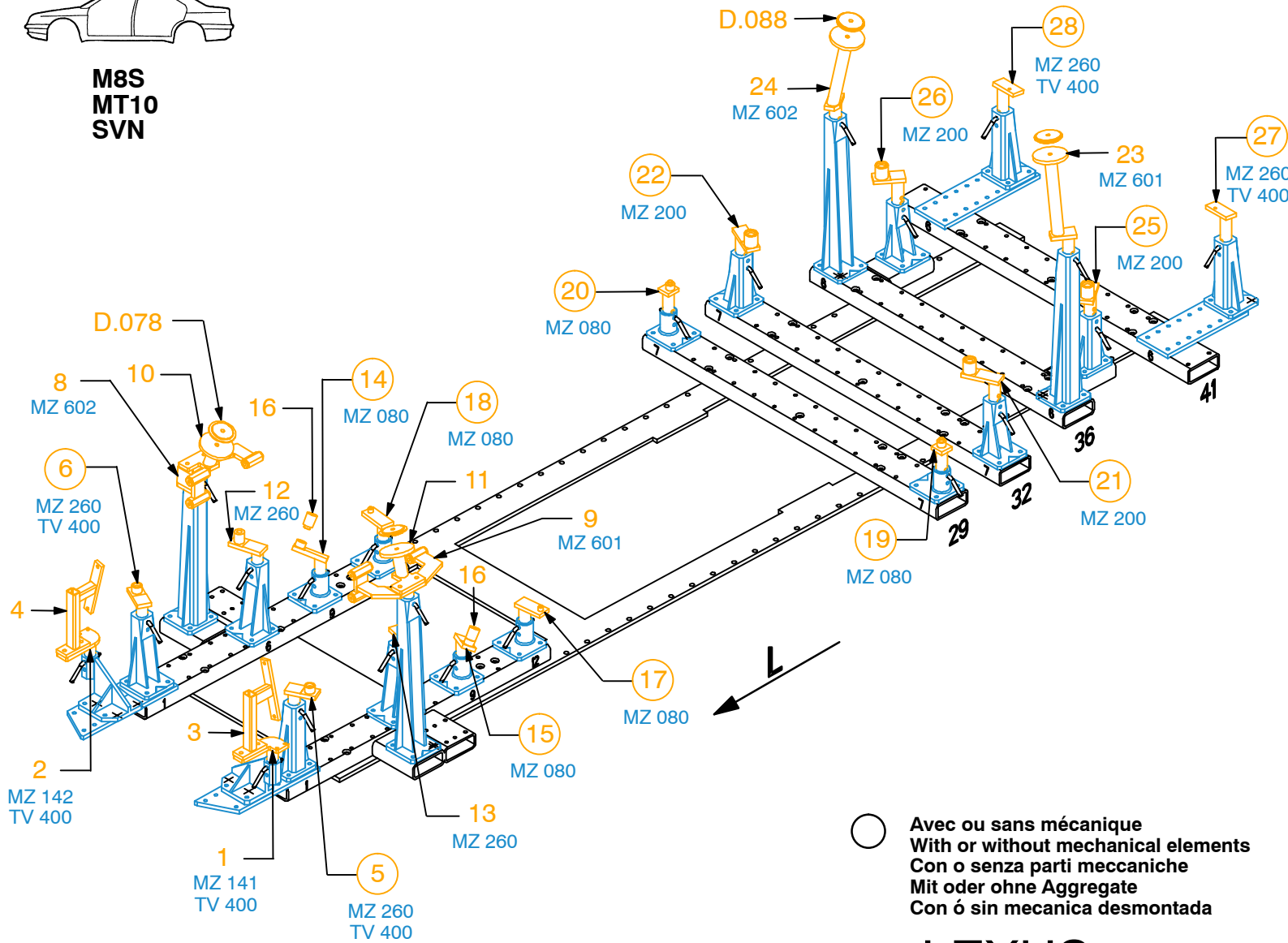

○ Avec ou sans mécanique  
With or without mechanical elements  
Con o senza parti meccaniche  
Mit oder ohne Aggregate  
Con ó sin mecanica desmontada

REP.	REFERENCE	PDS	NB	MZ
1	2115.7001	2,3	1	141
2	2115.7002	2,3	1	142
3	2115.7003	2,2	1	
4	2115.7004	2,2	1	
5	2115.7005	1,7	1	260/140
6	2115.7006	1,7	1	260/140
7	2115.7007	0,9	2	
8	2115.7008	5,2	1	602
9	2115.7009	5,2	1	601
10	2115.7010	2,4	1	
11	2115.7011	2,4	1	
12	2115.7012	2,0	1	260
13	2115.7013	2,0	1	260
14	2115.7014	1,9	1	080
15	2115.7015	1,9	1	080
16	2115.7016	0,3	2	
17	2115.7017	1,8	1	080
18	2115.7018	1,8	1	080
19	2115.7019	1,7	1	080
20	2115.7020	1,7	1	080
21	2115.7021	2,4	1	200/140
22	2115.7022	2,4	1	200/140
23	2115.7023	3,5	1	601
24	2115.7024	3,5	1	602
25	2115.7025	2,5	1	200/140
26	2115.7026	2,5	1	200/140
27	2115.7027	2,1	1	260
28	2115.7028	2,1	1	260
29	2115.7029	5,2	4	
	D.078	0,5	2	
	D.088	0,6	2	

M 8-30	6
M 12-30	4
M 12-40	8
M 16-50	2
M 10x1,25-30	4
M 10x1,25-100	2
M 14x1,50-50	4
M 14x1,50-130	4
TFHc 16-60	8
955714	16

M 12	8
------	---

**2115.300**

88 Kg 31.10.2007 434-D-86A

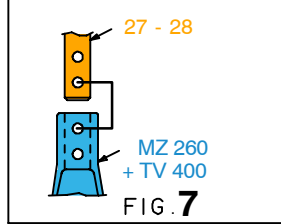
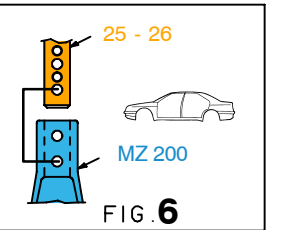
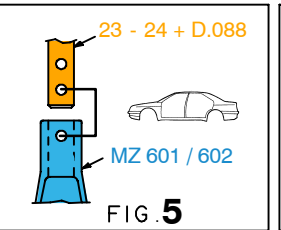
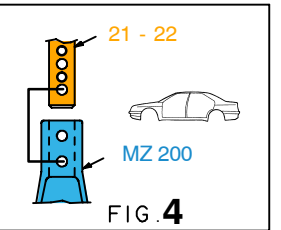
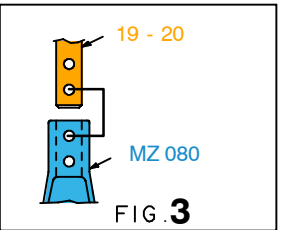
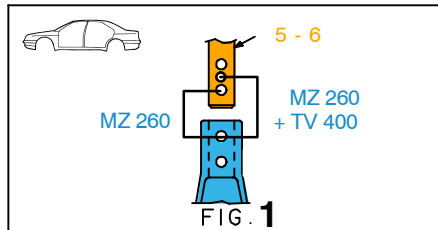
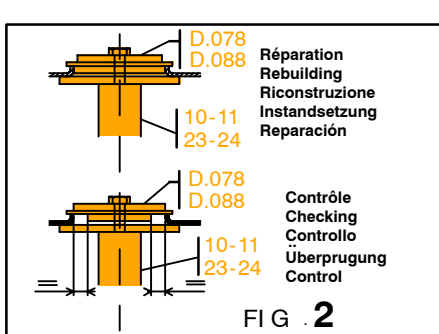
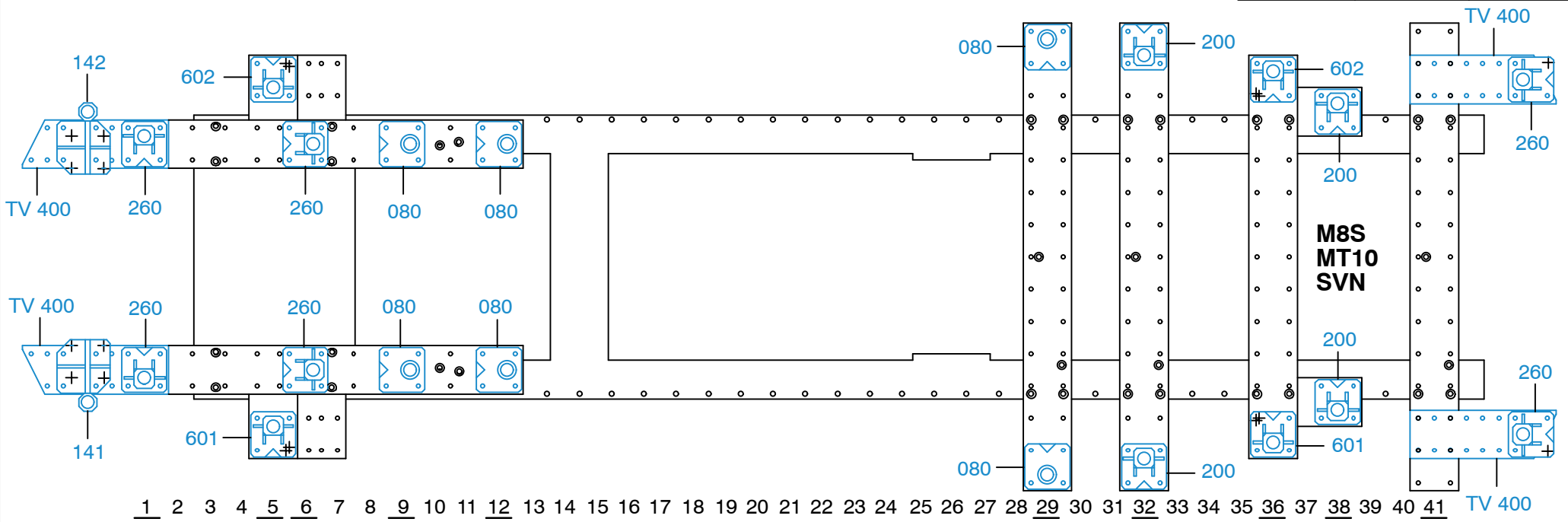

2115.300-RVA3-1 00

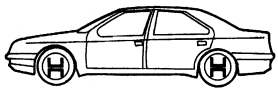

M8S  
MT10  
SVN

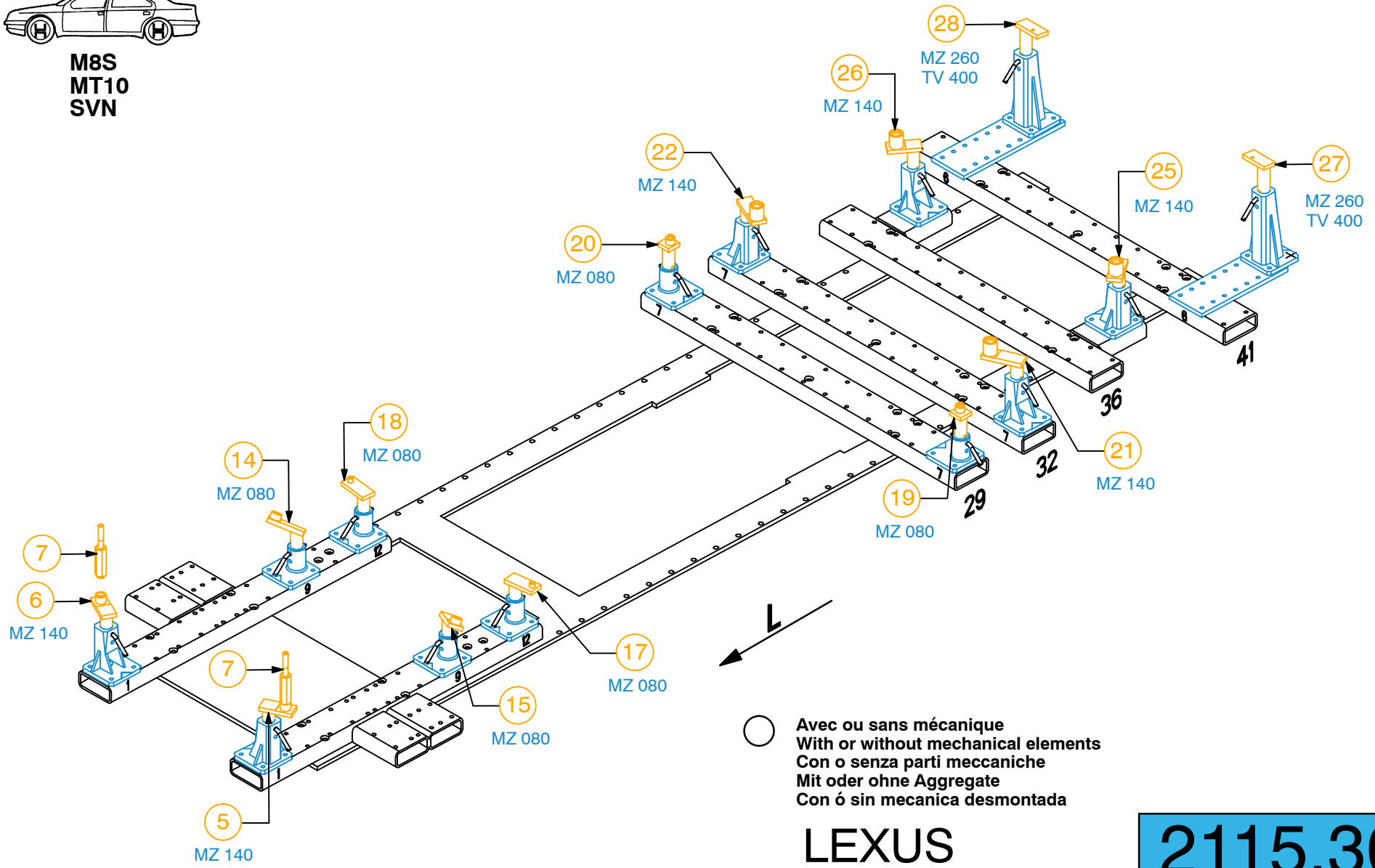

○ Avec ou sans mécanique  
With or without mechanical elements  
Con o senza parti meccaniche  
Mit oder ohne Aggregate  
Con ó sin mecánica desmontada

**LEXUS**

<b>2115.300</b>		
88 Kg	31.10.2007	434-D-86B

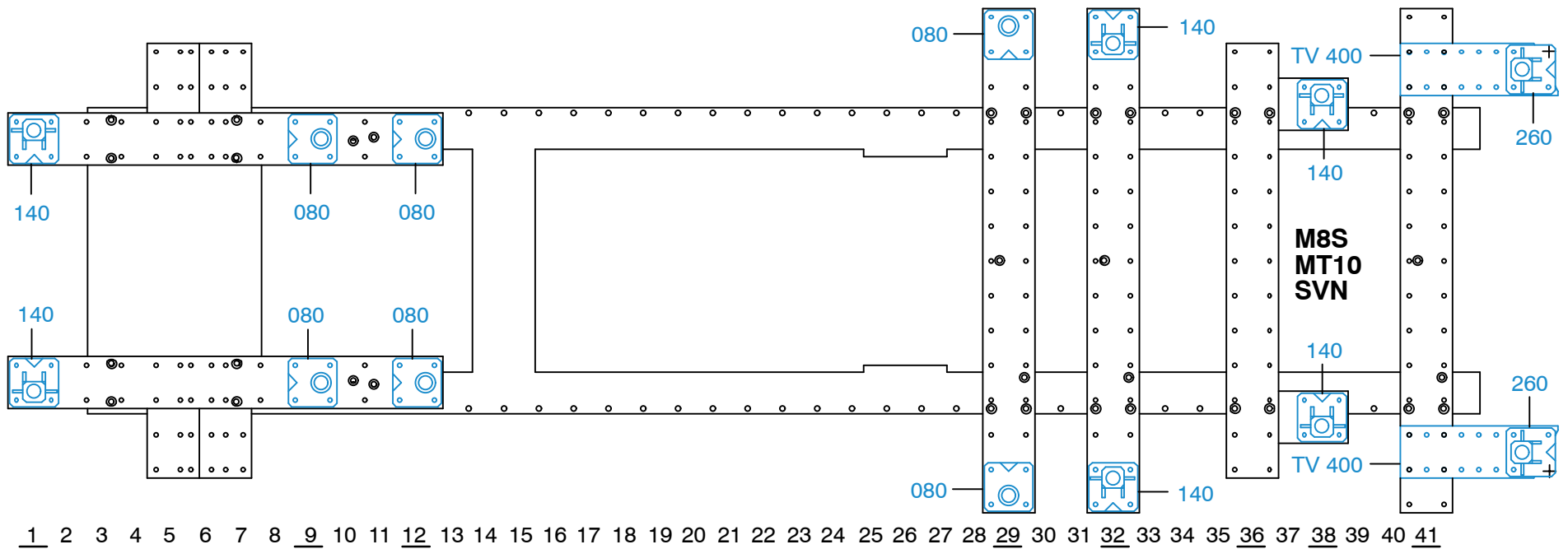

1 2 3 4 5 6 7 8 9 10 11 12 13 14 15 16 17 18 19 20 21 22 23 24 25 26 27 28 29 30 31 32 33 34 35 36 37 38 39 40 41

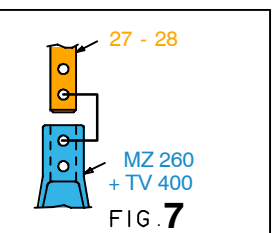
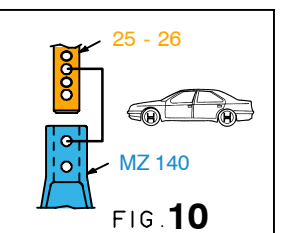
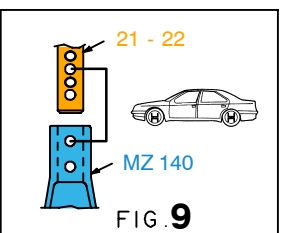
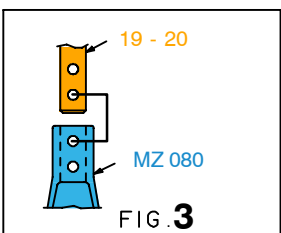
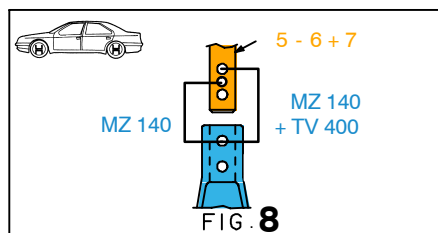

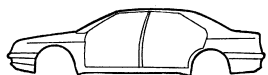

**M8S  
MT10  
SVN**

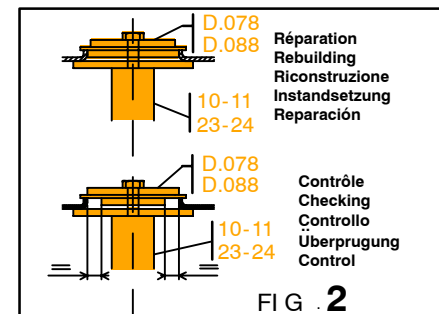
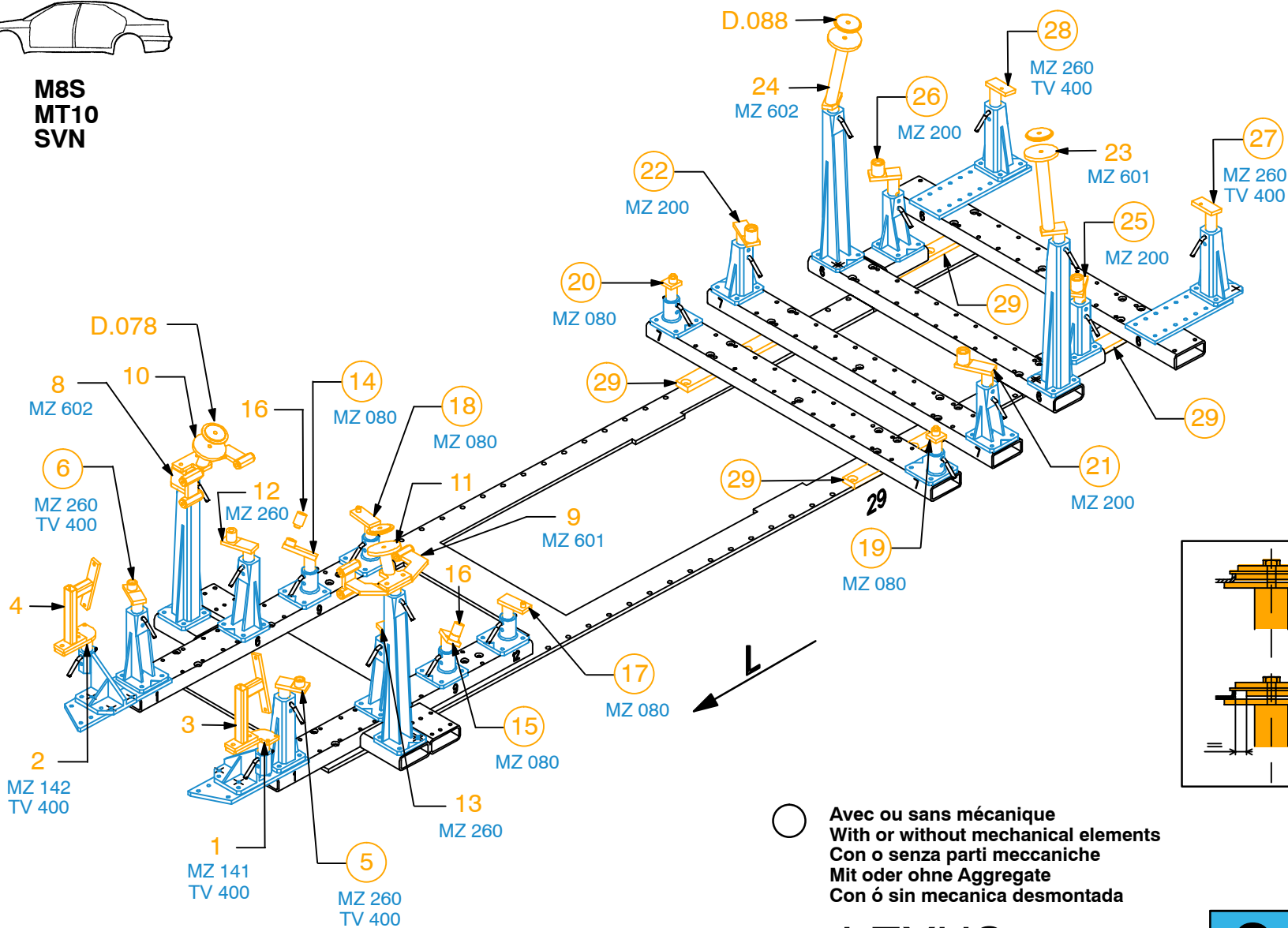

○ Avec ou sans mécanique  
With or without mechanical elements  
Con o senza parti meccaniche  
Mit oder ohne Aggregate  
Con ó sin mecanica desmontada

**LEXUS**

**2115.300**

88 Kg 31.10.2007 434-D-86C

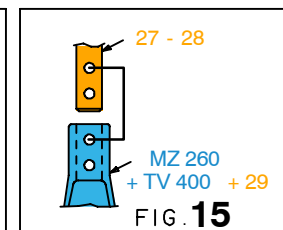
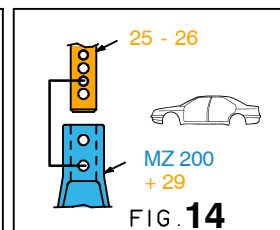
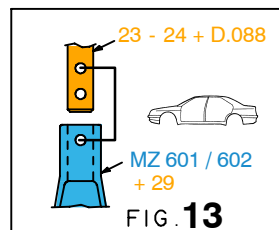
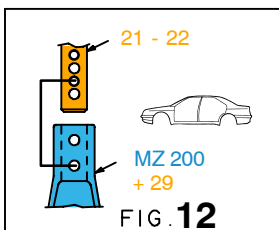
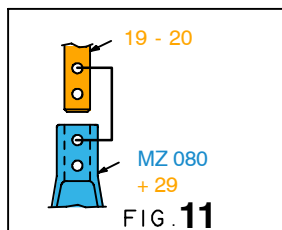
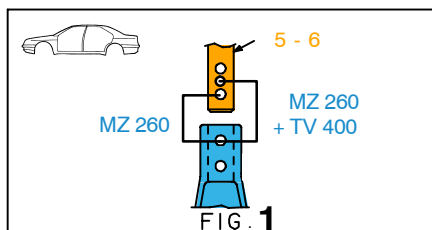
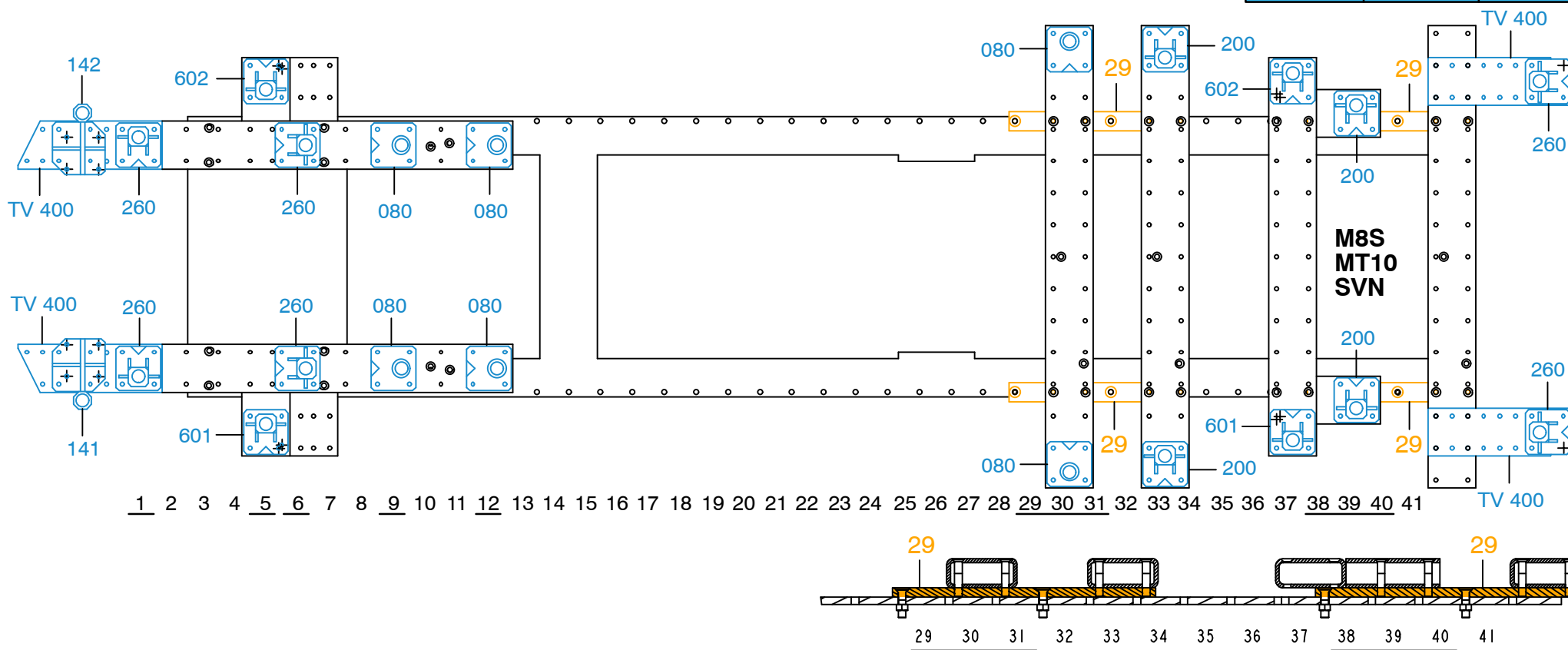

2115.300-RVA3-2 00

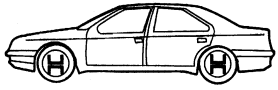

**M8S  
MT10  
SVN**

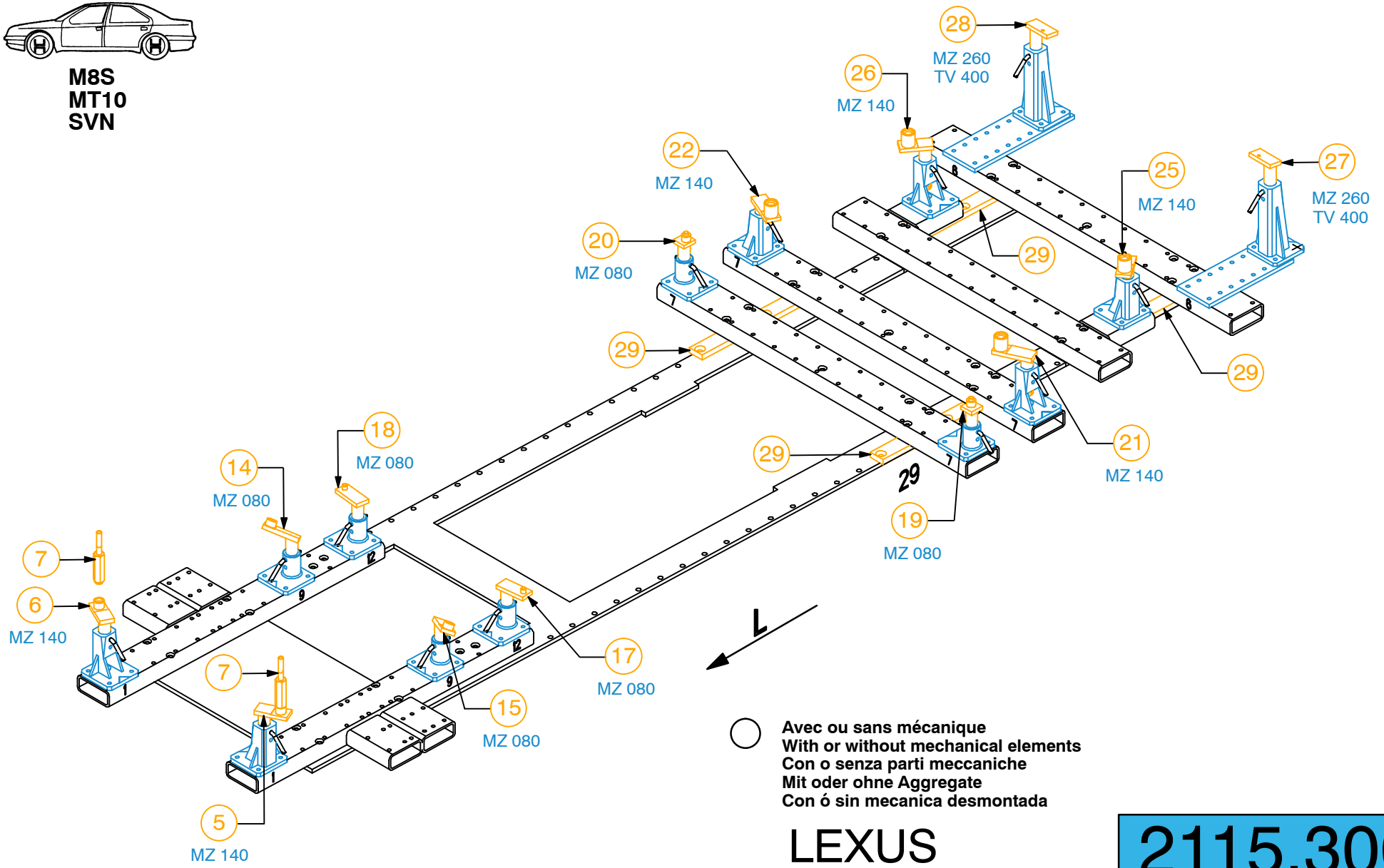

○ Avec ou sans mécanique  
With or without mechanical elements  
Con o senza parti meccaniche  
Mit oder ohne Aggregate  
Con ó sin mecánica desmontada

**LEXUS**

<b>2115.300</b>		
88 Kg	31.10.2007	434-D-86D

