

REP.	REFERENCE	PDS	NB	MZ
37	2114.7037	0,1	2	260
38	2114.7038	2,3	1	260
39	2114.7039	2,3	1	260

complément au
complementary set to
complemento al
zusatz zu

2114.300

2114.309

5 Kg 15.01.2008 440-D-25A

GM

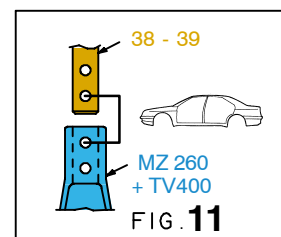
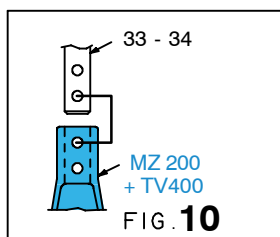
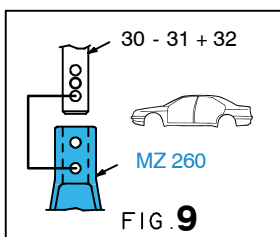
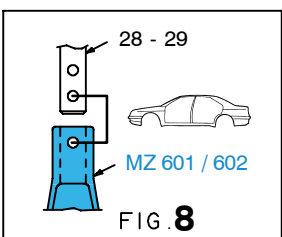
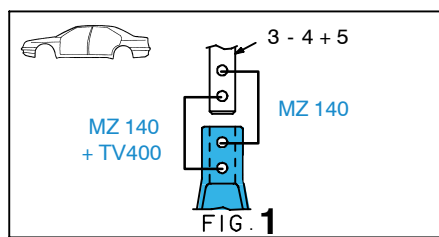
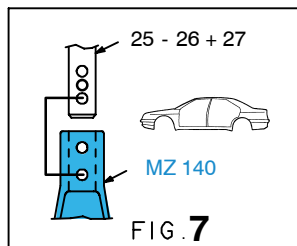
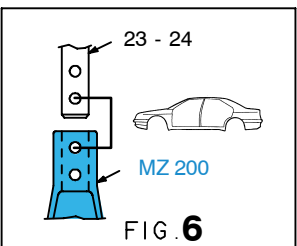
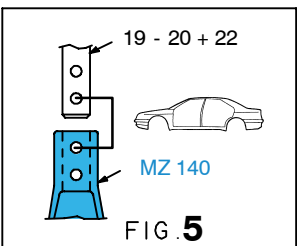
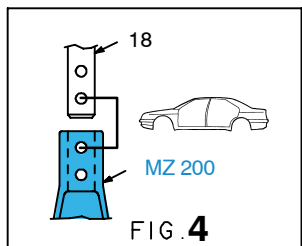
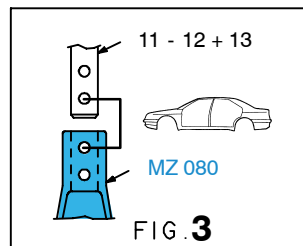
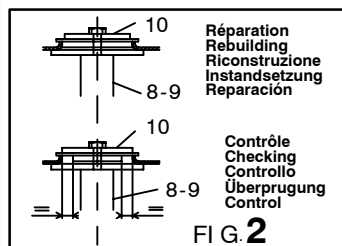
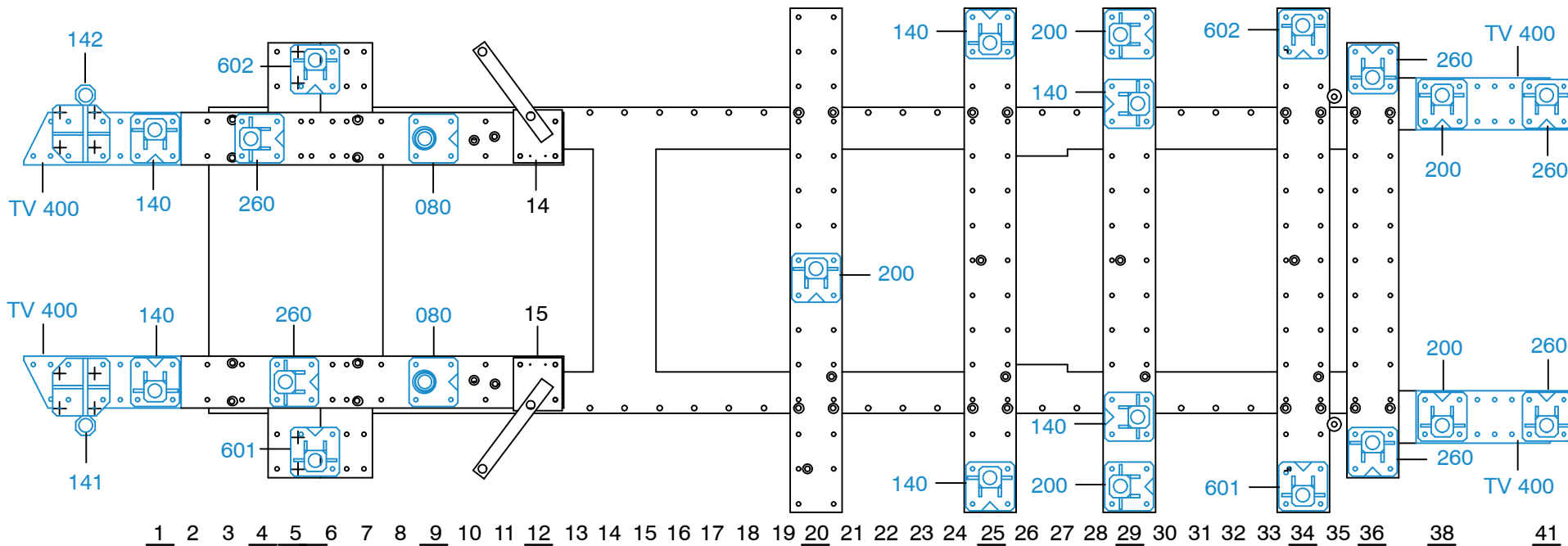

2114.309-RVA3-1 00

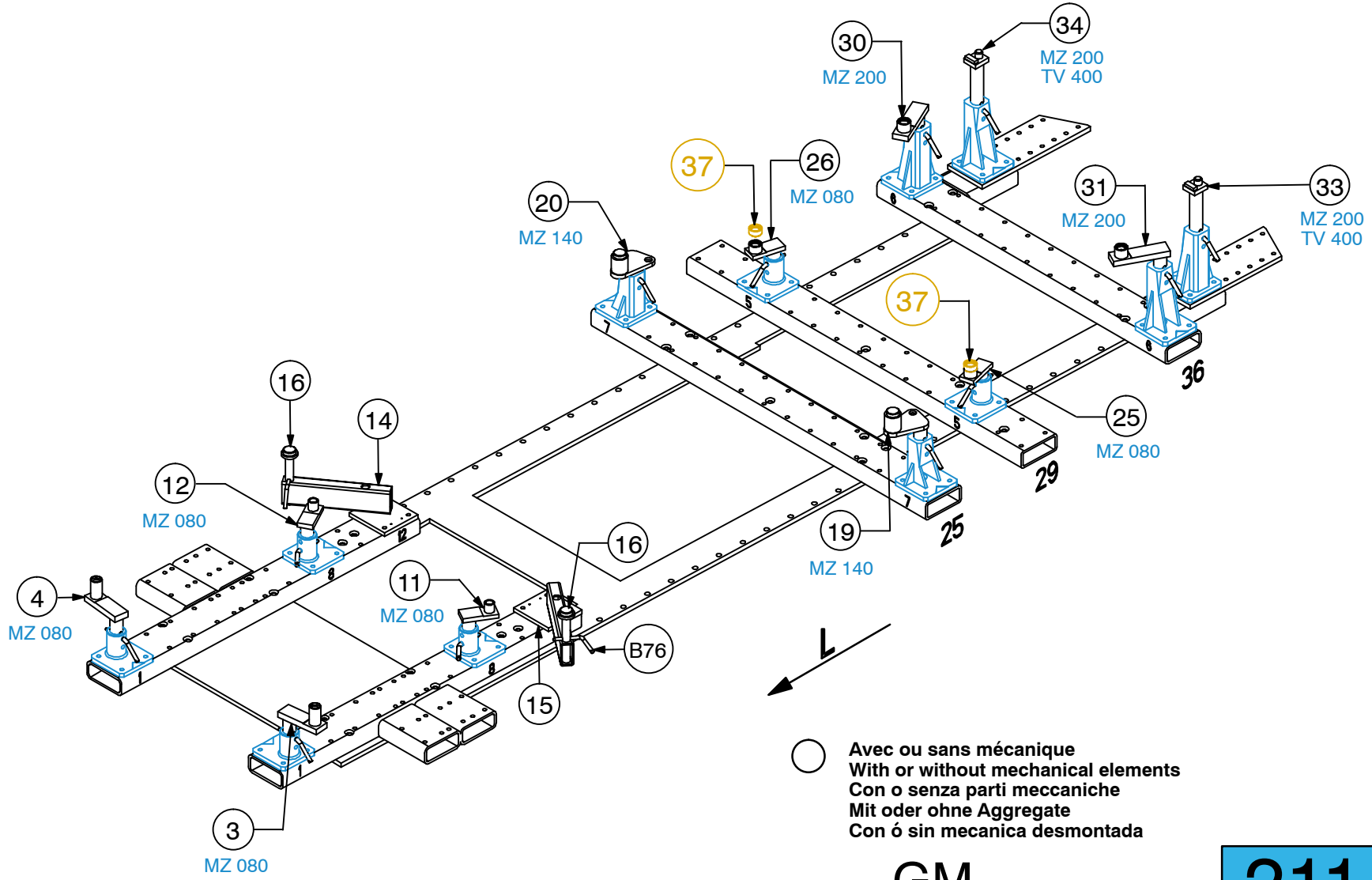
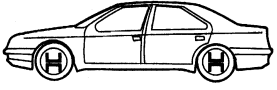

○ Avec ou sans mécanique
With or without mechanical elements
Con o senza parti meccaniche
Mit oder ohne Aggregate
Con ó sin mecanica desmontada

GM

2114.309		
5 Kg	15.01.2008	440-D-25B

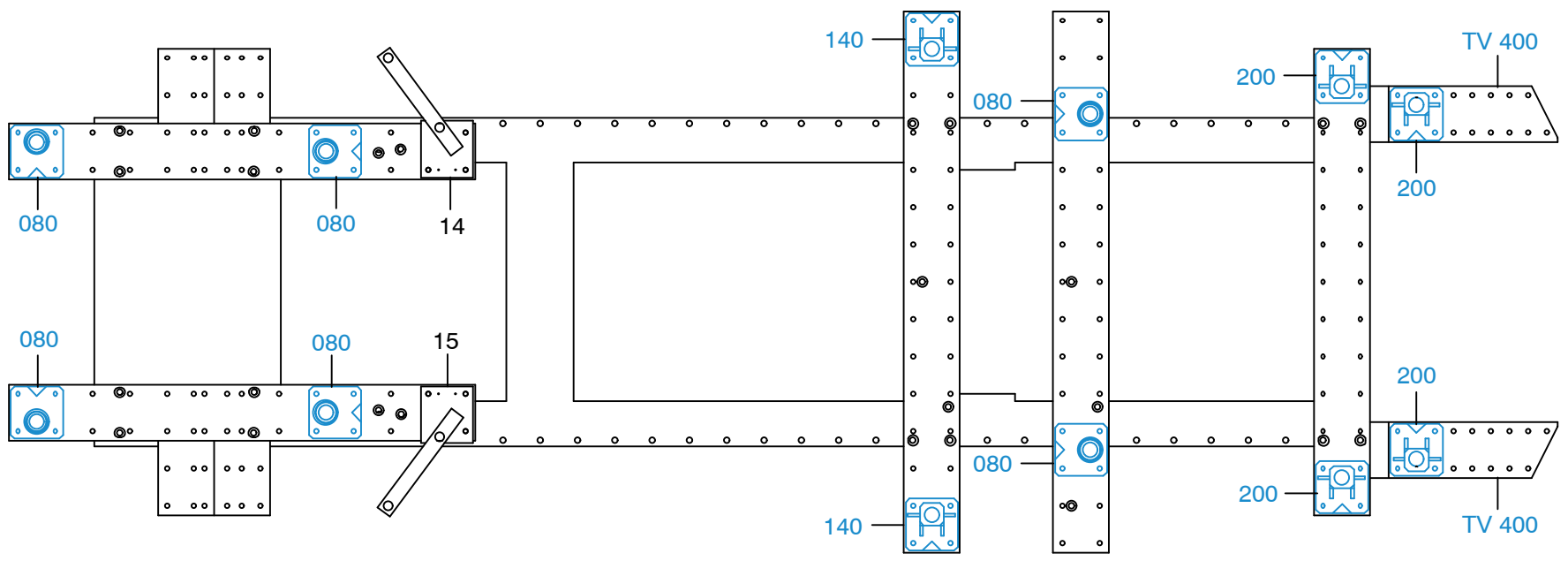

1 2 3 4 5 6 7 8 9 10 11 12 13 14 15 16 17 18 19 20 21 22 23 24 25 26 27 28 29 30 31 32 33 34 35 36 38

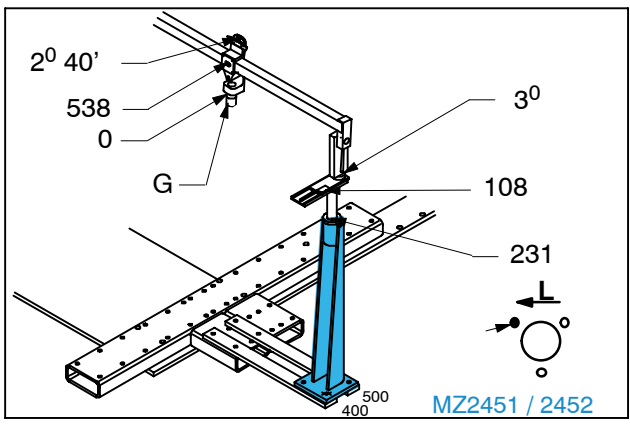

<p>3 - 4 MZ 080 FIG. 12</p>	<p>11 - 12 DIAG. MZ 080 FIG. 13</p>	<p>19 - 20 MZ 140 FIG. 14</p>
<p>25 - 26 + 37 MZ 080 FIG. 15</p>	<p>30 - 31 MZ 200 FIG. 16</p>	<p>33 - 34 MZ 200 + TV 400 FIG. 10</p>



2114.309-RVA3-1 | 00