

○ Avec ou sans mécanique
 With or without mechanical elements
 Con o senza parti meccaniche
 Mit oder ohne Aggregate
 Con ó sin mecanica desmontada

PEUGEOT / CITROEN

REP.	REFERENCE	PDS	NB	MZ
1	2097.7001	3,5	1	200
2	2097.7002	3,5	1	200
3	2097.7003	2,0	1	141
4	2097.7004	2,0	1	142
5	2097.7005	2,4	1	601
6	2097.7006	2,4	1	602
7	2097.7007	0,5	2	
8	2097.7008	1,5	1	260/080
9	2097.7009	1,5	1	260/080
10	2097.7010	0,4	2	
11	2097.7011	0,8	2	
12	2097.7012	2,0	1	140/080
13	2097.7013	2,0	1	140/080
14	2097.7014	0,3	2	
15	2097.7015	1,9	1	080
16	2097.7016	1,9	1	080
17	2097.7017	2,7	1	140
18	2097.7018	2,7	1	140
19	2097.7019	1,8	1	260/080
20	2097.7020	1,8	1	260/080
21	2097.7021	1,2	2	
22	2097.7022	3,2	1	260
23	2097.7023	3,2	1	260
24	2097.7024	2,4	1	260
25	2097.7025	2,4	1	260
26	2097.7026	3,2	1	200
27	2097.7027	3,2	1	200
28	2113.7001	1,0	1	

M 8-35	4
M 10-30	4
M 12-25	2
M 12-30	2
M 14-25	2
M 14-50	2
M 10x1,25-35	2
M 12x1,25-40	2
M 12x1,25-70	2
M 12x1,25-120	2
M 12x1,25-140	4
M 14x1,50-70	2
M 14x1,50-90	2

M 10	4
------	---

2113.300

62 Kg 16.03.2007 423-D-28A

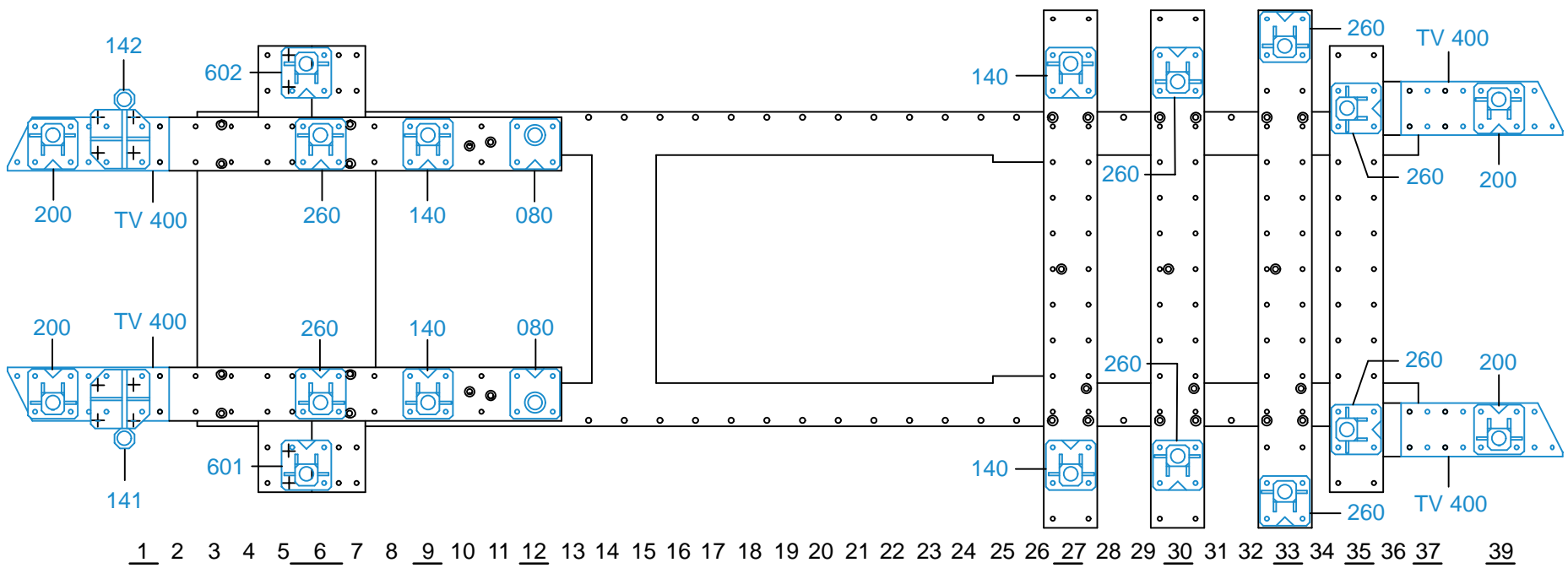

1 2 3 4 5 6 7 8 9 10 11 12 13 14 15 16 17 18 19 20 21 22 23 24 25 26 27 28 29 30 31 32 33 34 35 36 37 39

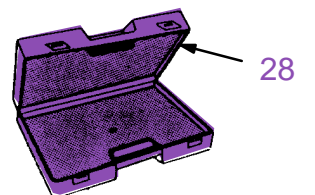
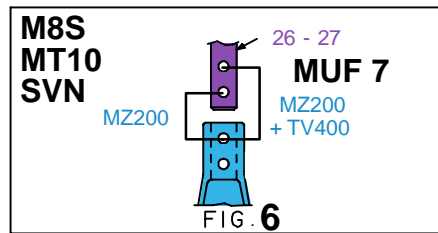
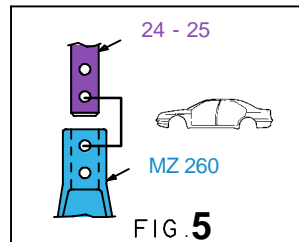
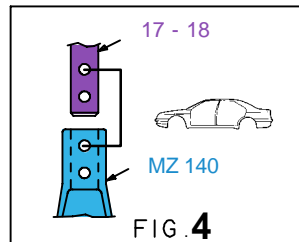
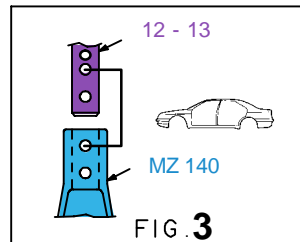
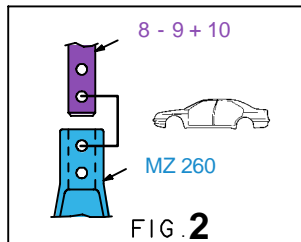
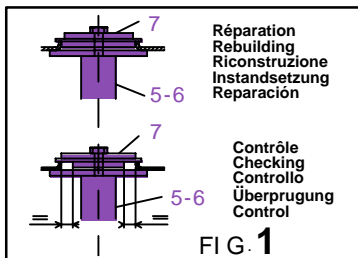

2113.300-RVA3-1 00

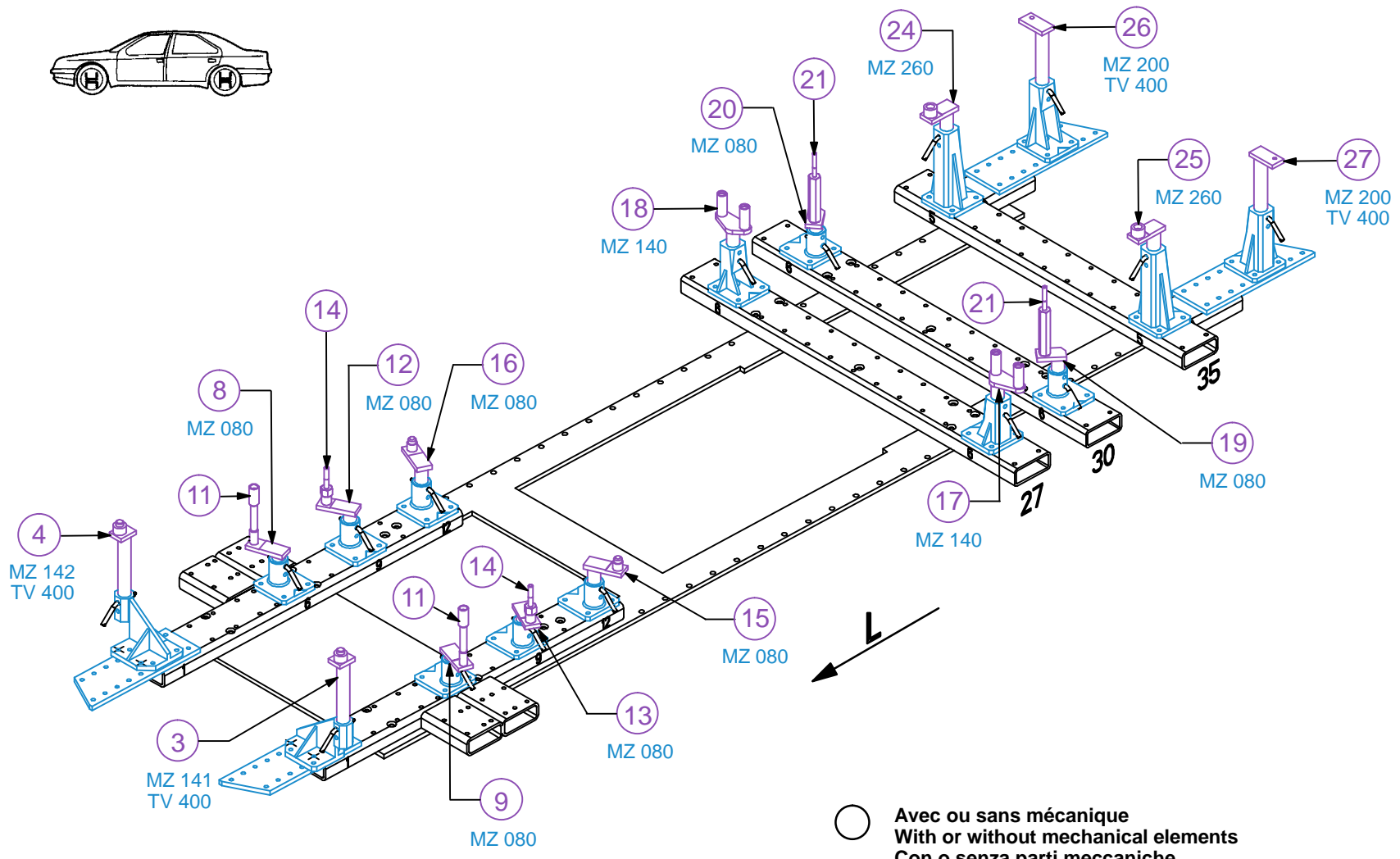

○ Avec ou sans mécanique
 With or without mechanical elements
 Con o senza parti meccaniche
 Mit oder ohne Aggregate
 Con ó sin mecanica desmontada

PEUGEOT / CITROEN

2113.300

62 Kg	16.03.2007	423-D-28B
-------	------------	-----------

