

REP.	REFERENCE	PDS	NB	MZ
28	2097.7028	3,2	1	200
29	2097.7029	3,2	1	200
30	2097.7030	0,7	2	
31	2097.7031	4,0	1	601
32	2097.7032	4,0	1	602
33	2097.7033	2,8	1	140
34	2097.7034	2,8	1	140
35	2097.7035	0,4	2	
36	2097.7036	1,8	1	260
37	2097.7037	1,8	1	260
38	2097.7038	3,0	1	260
39	2097.7039	3,0	1	260
40	2097.7040	2,4	1	260
41	2097.7041	2,4	1	260
42	2097.7042	3,2	1	200
43	2097.7043	3,2	1	200

○ Avec ou sans mécanique
 With or without mechanical elements
 Con o senza parti meccaniche
 Mit oder ohne Aggregate
 Con ó sin mecanica desmontada

complément au
 complementary set to
 complemento al
 zusatz zu

2097.300
 Ou/Or/Oder/O
2113.300

DODGE

2097.309

43 Kg 31.03.2008 442-D-14A

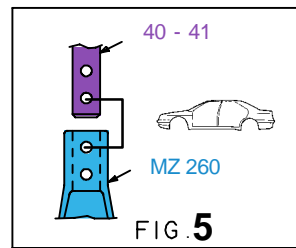
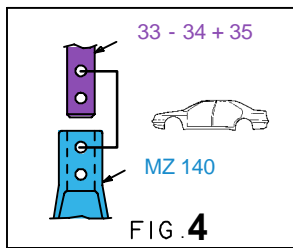
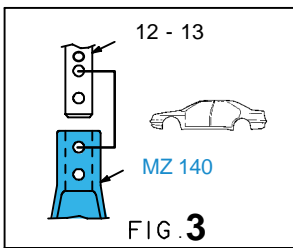
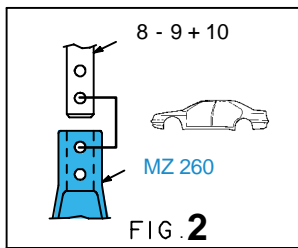
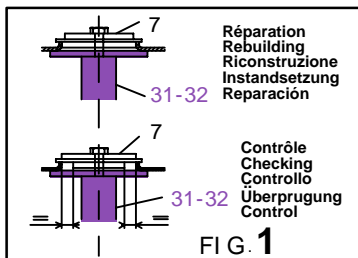
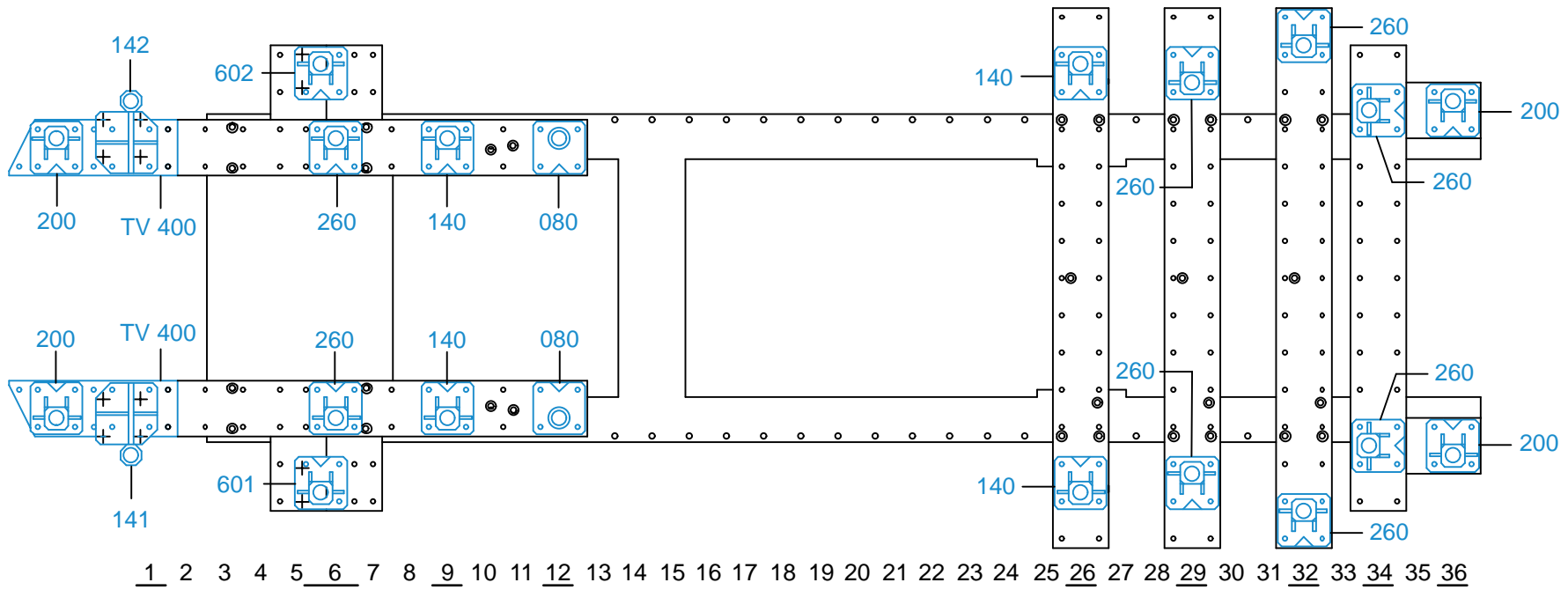

2097.309-RVA3-1 00

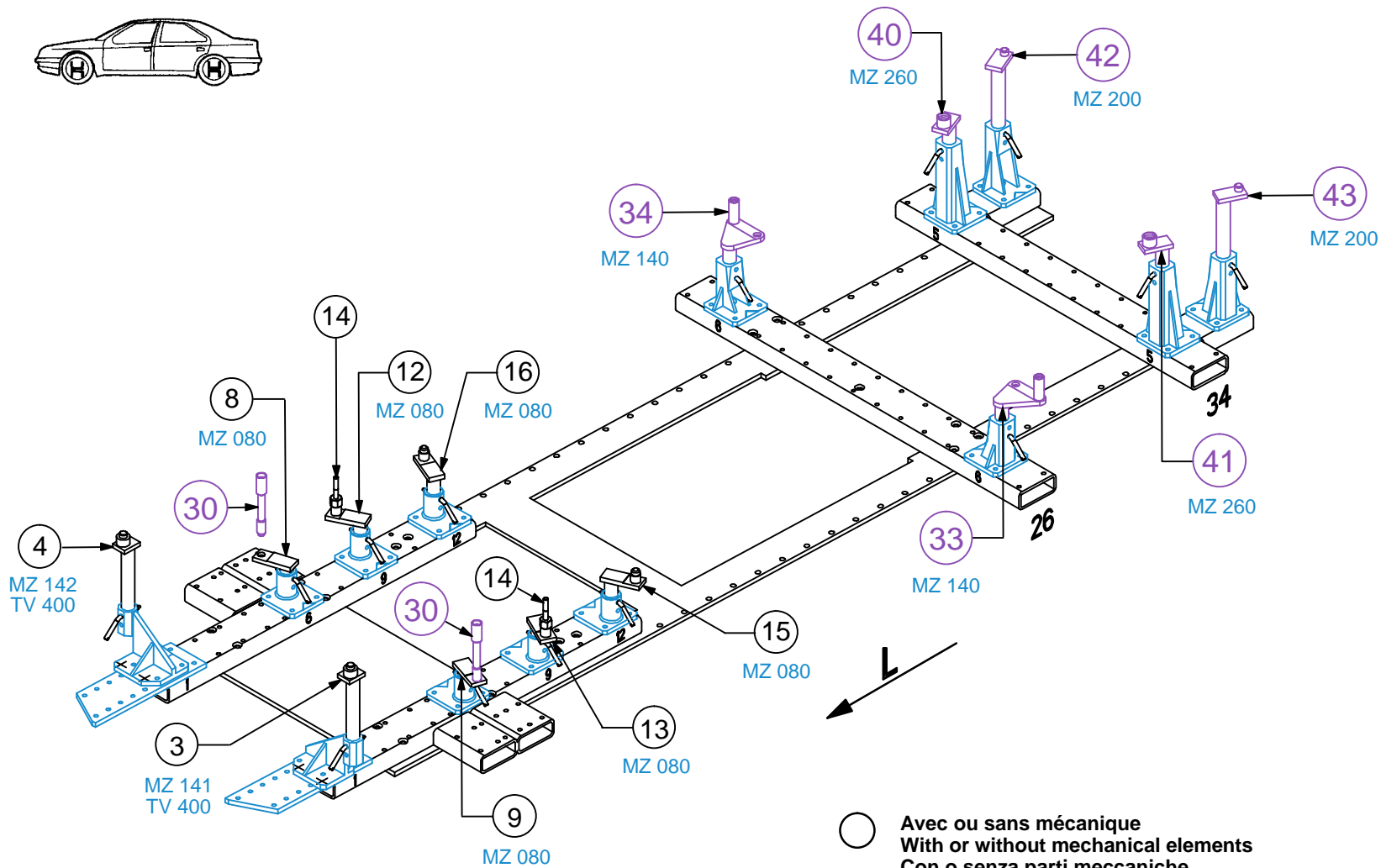
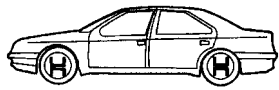

○ Avec ou sans mécanique
 With or without mechanical elements
 Con o senza parti meccaniche
 Mit oder ohne Aggregate
 Con ó sin mecánica desmontada

DODGE

2097.309		
43 Kg	31.03.2008	442-D-14B

