

○ Avec ou sans mécanique
 With or without mechanical elements
 Con o senza parti meccaniche
 Mit oder ohne Aggregate
 Con ó sin mecanica desmontada

MITSUBISHI

| REP. | REFERENCE | PDS | NB | MZ |
|------|-----------|-----|----|---------|
| 1 | 2097.7001 | 3,5 | 1 | 200 |
| 2 | 2097.7002 | 3,5 | 1 | 200 |
| 3 | 2097.7003 | 2,0 | 1 | 141 |
| 4 | 2097.7004 | 2,0 | 1 | 142 |
| 5 | 2097.7005 | 2,4 | 1 | 601 |
| 6 | 2097.7006 | 2,4 | 1 | 602 |
| 7 | 2097.7007 | 0,5 | 2 | |
| 8 | 2097.7008 | 1,5 | 1 | 260/080 |
| 9 | 2097.7009 | 1,5 | 1 | 260/080 |
| 10 | 2097.7010 | 0,4 | 2 | |
| 11 | 2097.7011 | 0,8 | 2 | |
| 12 | 2097.7012 | 2,0 | 1 | 140/080 |
| 13 | 2097.7013 | 2,0 | 1 | 140/080 |
| 14 | 2097.7014 | 0,3 | 2 | |
| 15 | 2097.7015 | 1,9 | 1 | 080 |
| 16 | 2097.7016 | 1,9 | 1 | 080 |
| 17 | 2097.7017 | 2,7 | 1 | 140 |
| 18 | 2097.7018 | 2,7 | 1 | 140 |
| 19 | 2097.7019 | 1,8 | 1 | 260/080 |
| 20 | 2097.7020 | 1,8 | 1 | 260/080 |
| 21 | 2097.7021 | 1,2 | 2 | |
| 22 | 2097.7022 | 3,2 | 1 | 260 |
| 23 | 2097.7023 | 3,2 | 1 | 260 |
| 24 | 2097.7024 | 2,4 | 1 | 260 |
| 25 | 2097.7025 | 2,4 | 1 | 260 |
| 26 | 2097.7026 | 3,2 | 1 | 200 |
| 27 | 2097.7027 | 3,2 | 1 | 200 |

| | |
|---------------|---|
| M 8-35 | 4 |
| M 10-30 | 4 |
| M 12-25 | 2 |
| M 12-30 | 2 |
| M 14-25 | 2 |
| M 14-50 | 2 |
| M 10x1,25-35 | 2 |
| M 12x1,25-40 | 2 |
| M 12x1,25-70 | 2 |
| M 12x1,25-120 | 2 |
| M 12x1,25-140 | 4 |
| M 14x1,50-70 | 2 |
| M 14x1,50-90 | 2 |

| | |
|------|---|
| M 10 | 4 |
|------|---|

2097.300

61 Kg 19.12.2006 421-D-34A

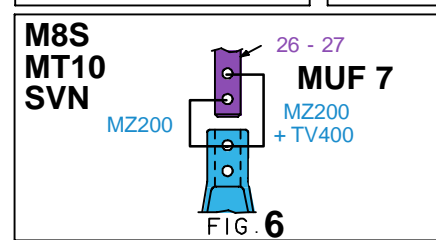
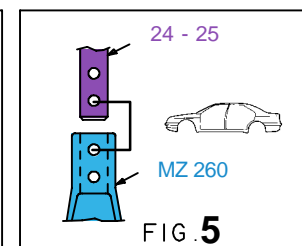
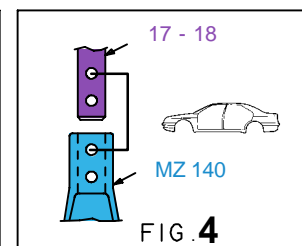
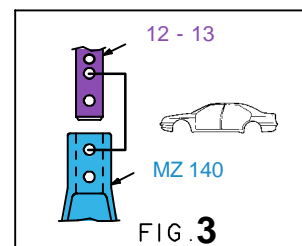
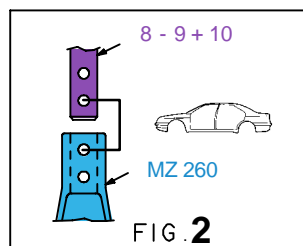
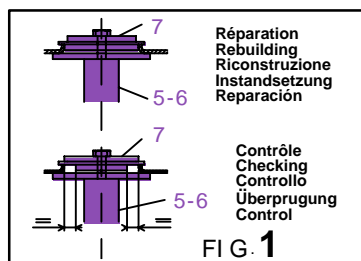
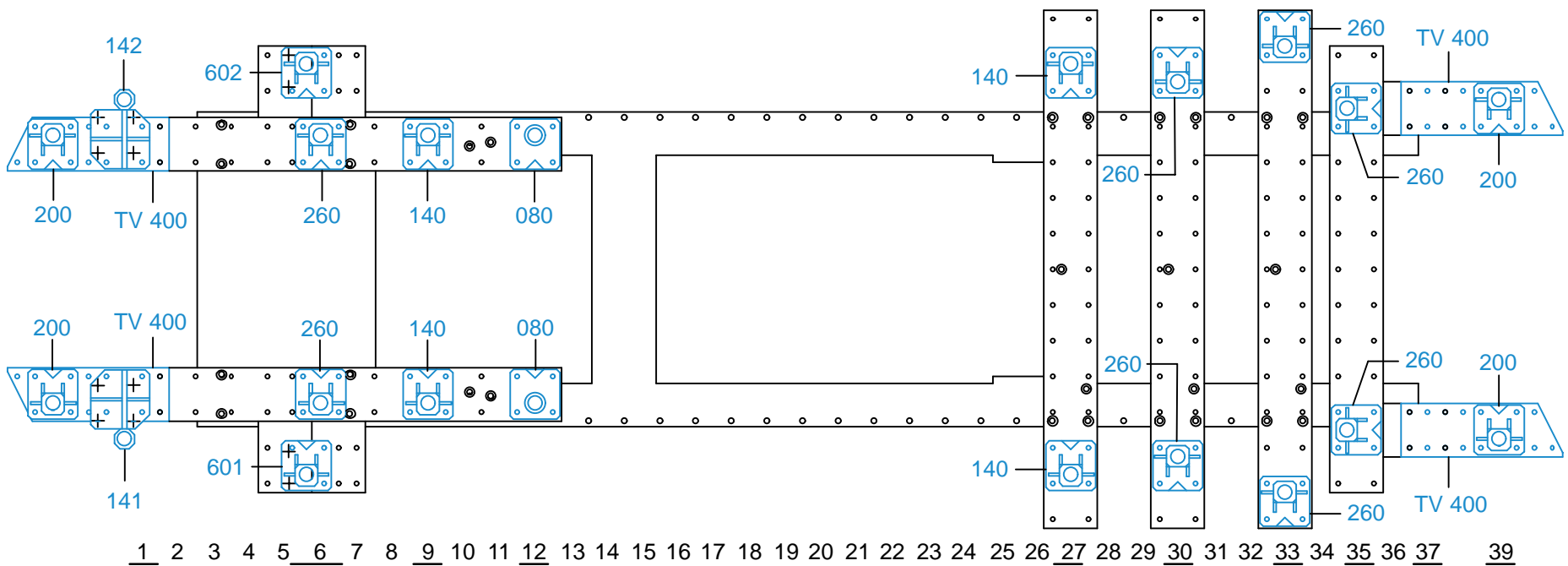

2097.300-RVA3-1 00

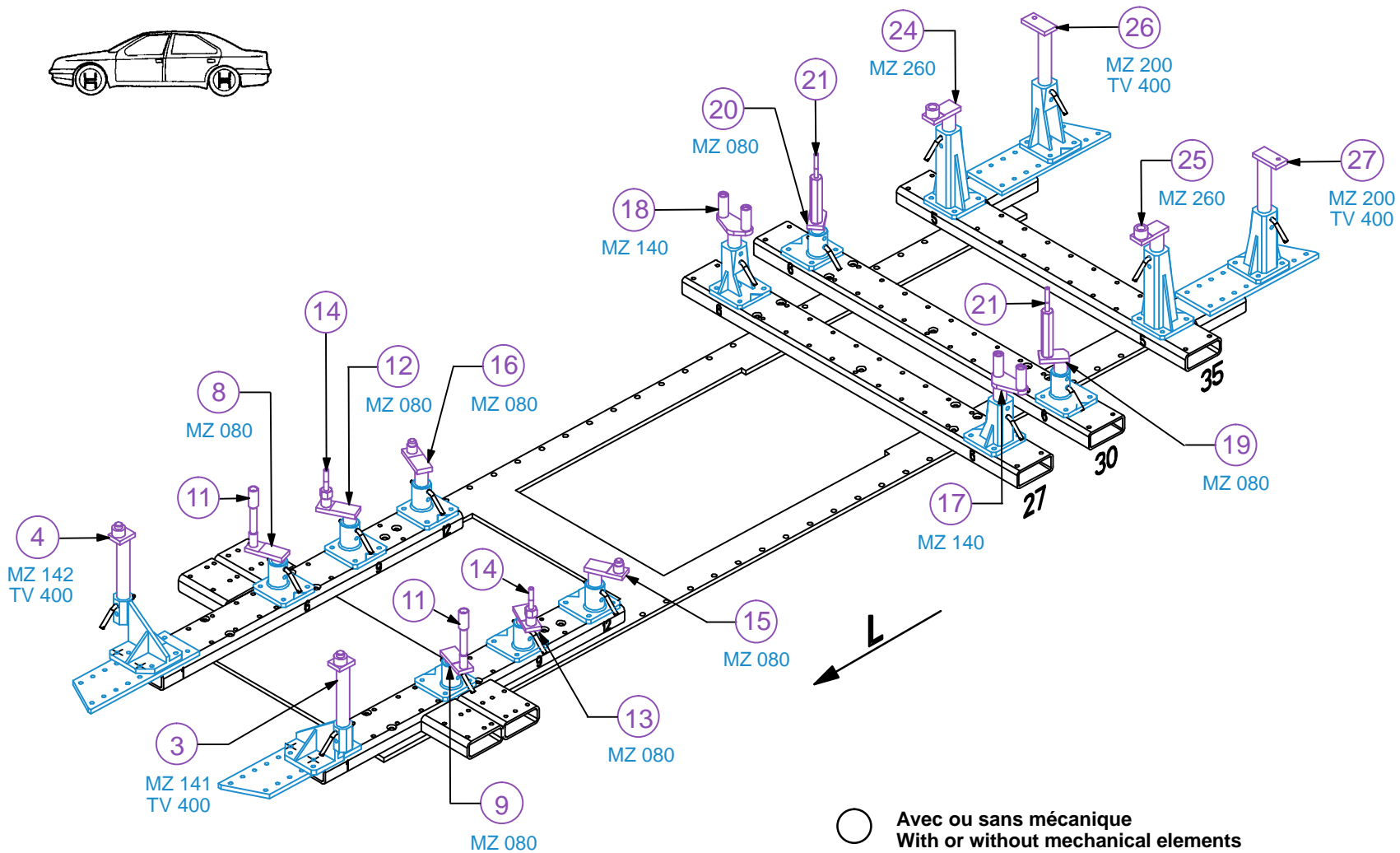

○ Avec ou sans mécanique
 With or without mechanical elements
 Con o senza parti meccaniche
 Mit oder ohne Aggregate
 Con ó sin mecánica desmontada

MITSUBISHI

| | | |
|----------|------------|-----------|
| 2097.300 | | |
| 61 Kg | 11.10.2006 | 421-D-34B |

