

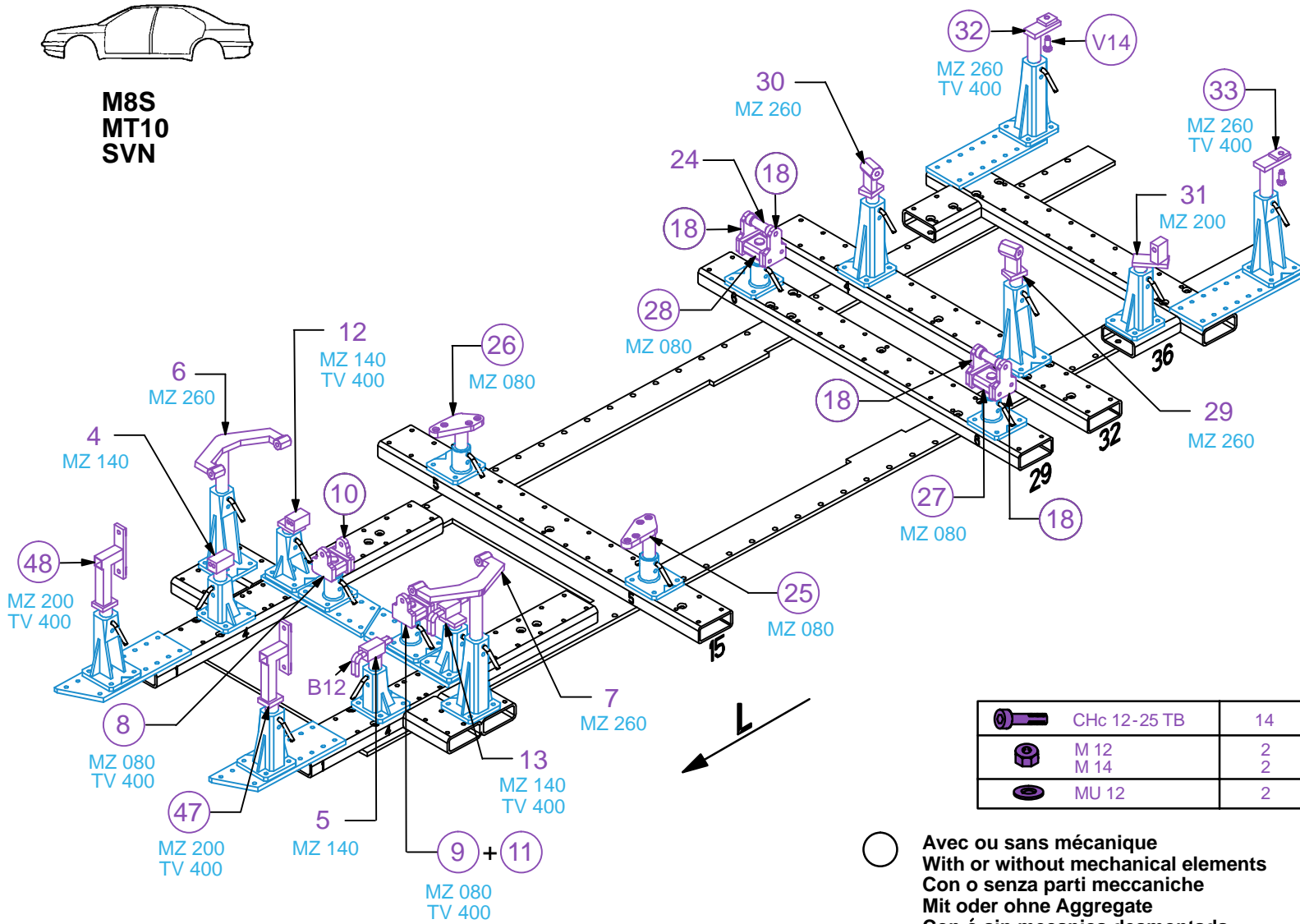

**M8S  
MT10  
SVN**



	CHc 12-25 TB	14
	M 12 M 14	2
	MU 12	2

○ Avec ou sans mécanique  
With or without mechanical elements  
Con o senza parti meccaniche  
Mit oder ohne Aggregate  
Con ó sin mecanica desmontada

REP.	REFERENCE	PDS	NB	MZ
4	2016.7004	1,9	1	140
5	2016.7005	1,9	1	140
6	2016.7006	5,2	1	260
7	2016.7007	5,2	1	260
8	2016.7008	2,6	1	080
9	2016.7009	2,6	1	080
10	2016.7010	0,7	1	
11	2016.7011	0,7	1	
12	2016.7012	2,0	1	140
13	2016.7013	2,0	1	140
18	2016.7018	0,9	4	
22	2016.7022	2,4	1	260
23	2016.7023	2,4	1	260
24	2016.7024	0,1	2	
25	2016.7025	3,0	1	080
26	2016.7026	3,0	1	080
27	2016.7027	2,6	1	080
28	2016.7028	2,6	1	080
29	2016.7029	2,5	1	260
30	2016.7030	2,5	1	260
31	2016.7031	2,3	1	200
32	2016.7032	2,5	1	260
33	2016.7033	2,5	1	260
34	2016.7034	2,4	7	
35	2016.7035	3,8	1	080
36	2016.7036	3,8	1	080
37	2016.7037	2,6	1	140
38	2016.7038	2,6	1	140
39	2016.7039	2,0	1	260
40	2016.7040	2,0	1	260
41	2016.7041	2,0	1	200
42	2016.7042	2,0	1	200
43	2016.7043	1,0	2	
44	2016.7044	1,0	2	
45	2016.7045	2,4	1	260
46	2016.7046	2,4	1	260
47	2016.7047	2,8	1	200
48	2016.7048	2,8	1	200
49	2016.7049	0,2	2	
50	2016.7050	0,2	2	
51	2016.7051	0,1	4	
52	2016.7052	0,1	4	
	V14	0,1	2	
	B12	0,2	8	

M 12-20	2
M 12-25	14
M 12-30	16
M 12-50	2
M 14-120	2
M 14-160	1
M 10x1,25-40	4
M 10x1,25-70	4
M 12x1,25-40	4
M 14x1,50-60	2

**SSANG YONG**

**2093.300**

115 Kg    29.06.2006    456-D-5J

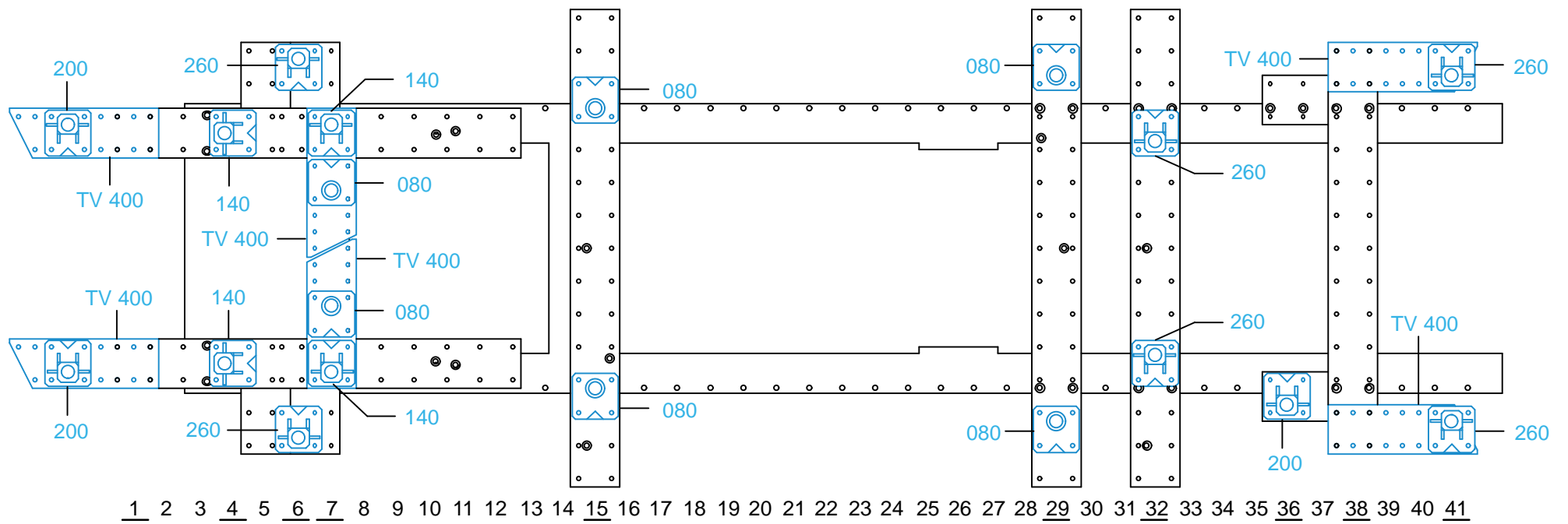

1 2 3 4 5 6 7 8 9 10 11 12 13 14 15 16 17 18 19 20 21 22 23 24 25 26 27 28 29 30 31 32 33 34 35 36 37 38 39 40 41

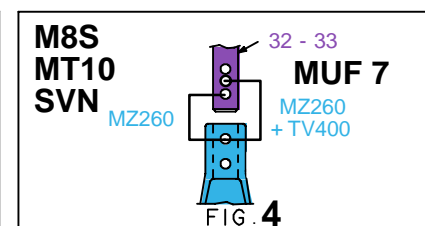
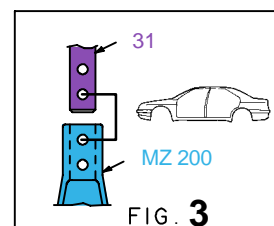
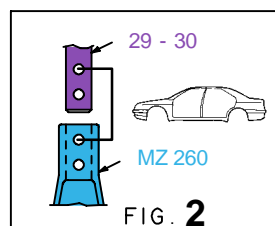
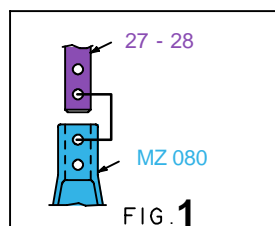

2093.300-RVA3-1 00

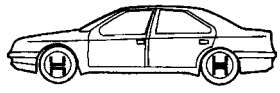

M8S  
MT10  
SVN

11 = RHD

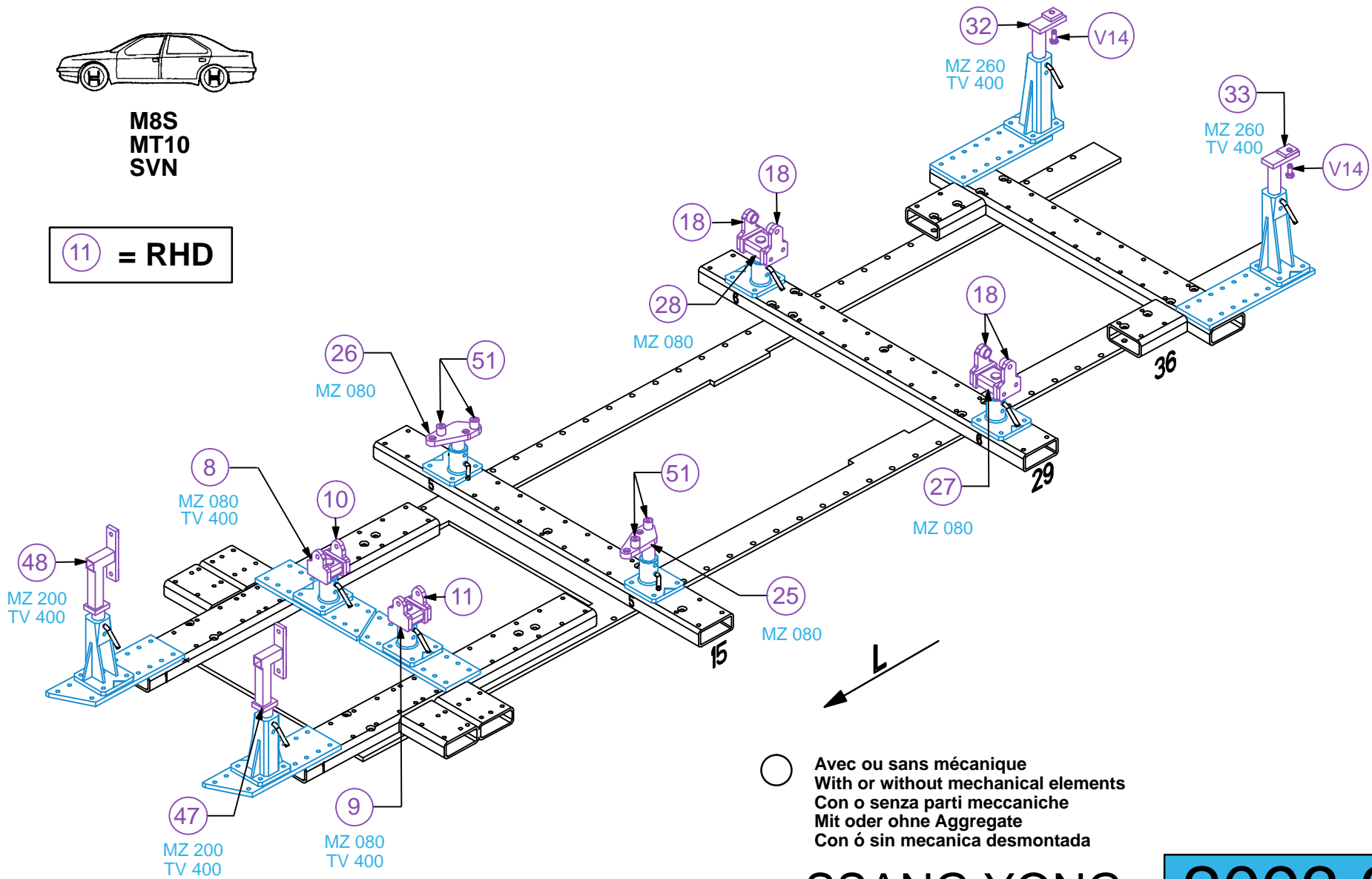

**SSANG YONG**

**2093.300**

115 Kg | 29.06.2006 | 456-D-5P

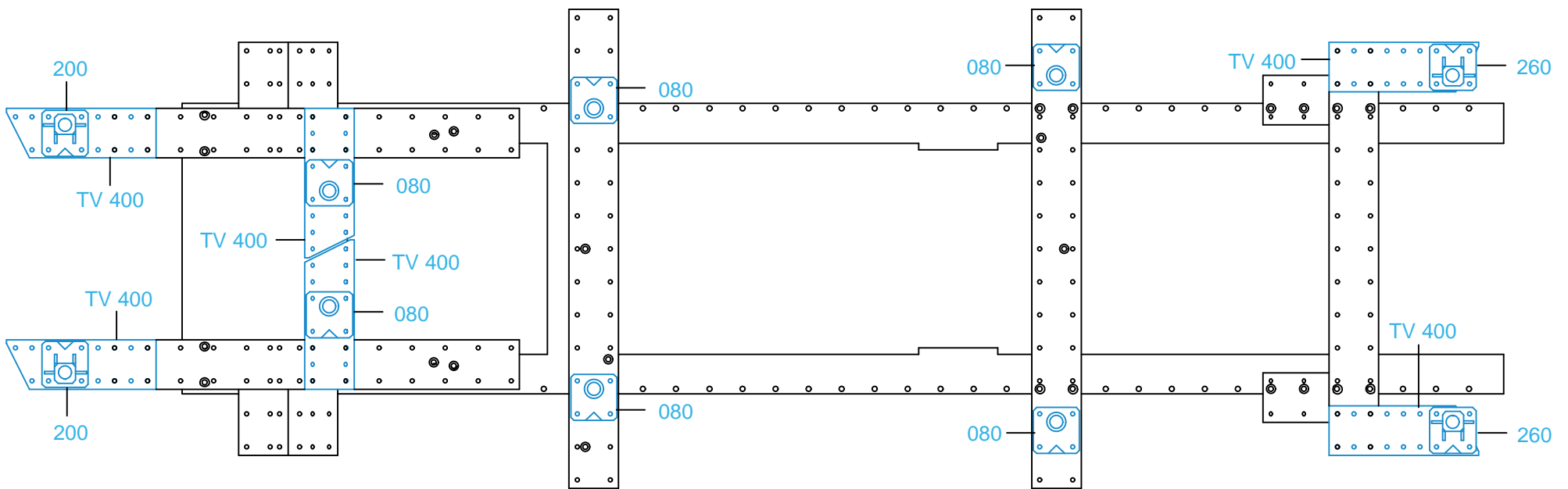

1 2 3 4 5 6 7 8 9 10 11 12 13 14 15 16 17 18 19 20 21 22 23 24 25 26 27 28 29 30 31 32 33 34 35 36 37 38 39 40 41

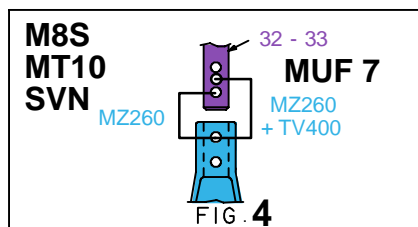
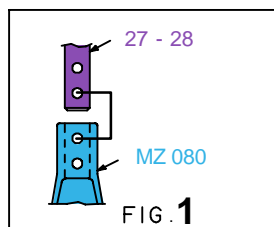
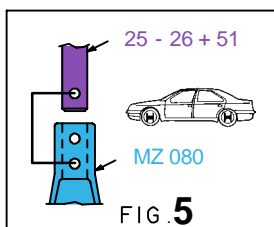



**M8S  
MT10  
SVN**

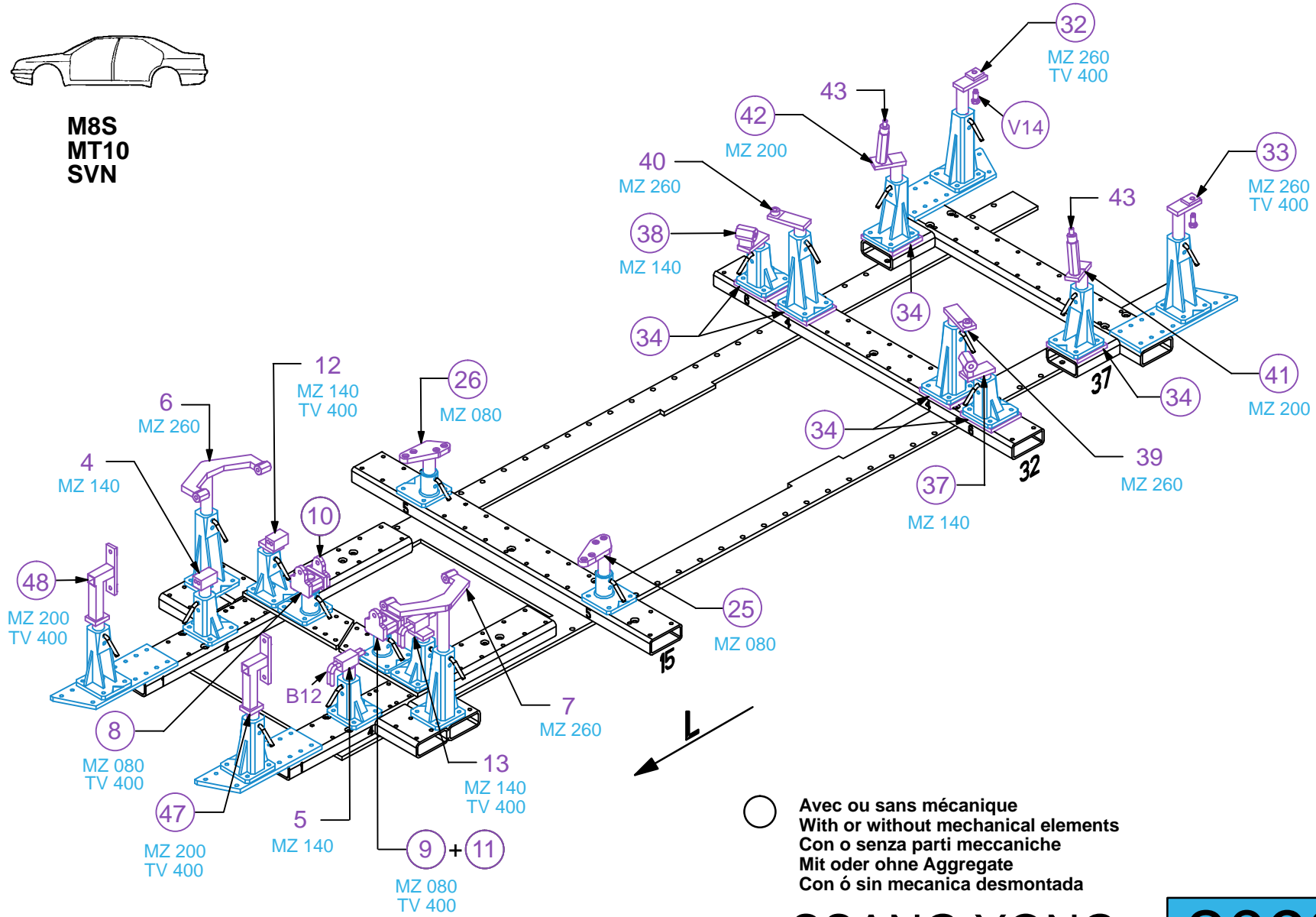

○ Avec ou sans mécanique  
With or without mechanical elements  
Con o senza parti meccaniche  
Mit oder ohne Aggregate  
Con ó sin mecanica desmontada

**SSANG YONG**

**2093.300**

115 Kg | 31.05.2006 | 456-D-5Q

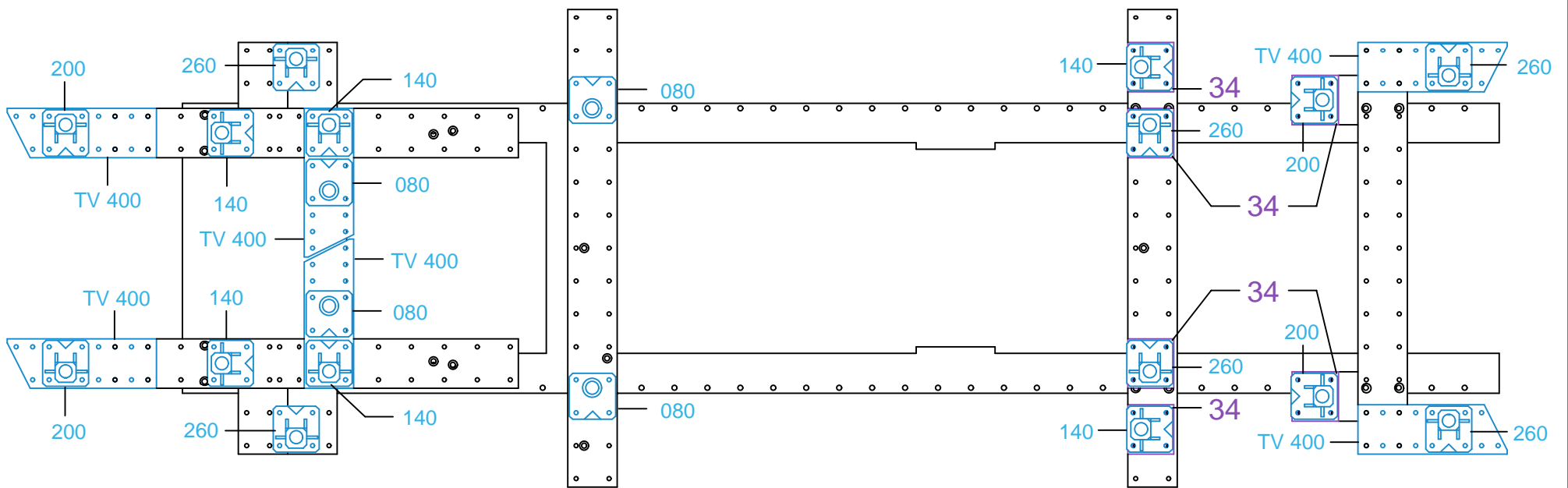

1 2 3 4 5 6 7 8 9 10 11 12 13 14 15 16 17 18 19 20 21 22 23 24 25 26 27 28 29 30 31 32 33 34 35 36 37 38 39 40 41

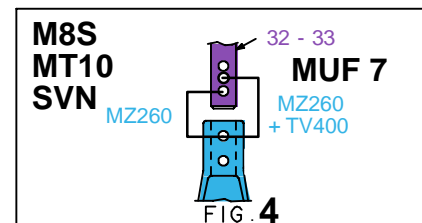
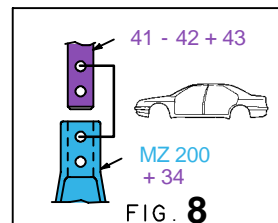
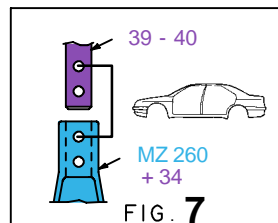
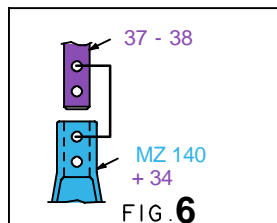

2093.300-RVA3-2 | 00

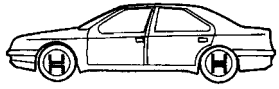

M8S  
MT10  
SVN

11 = RHD

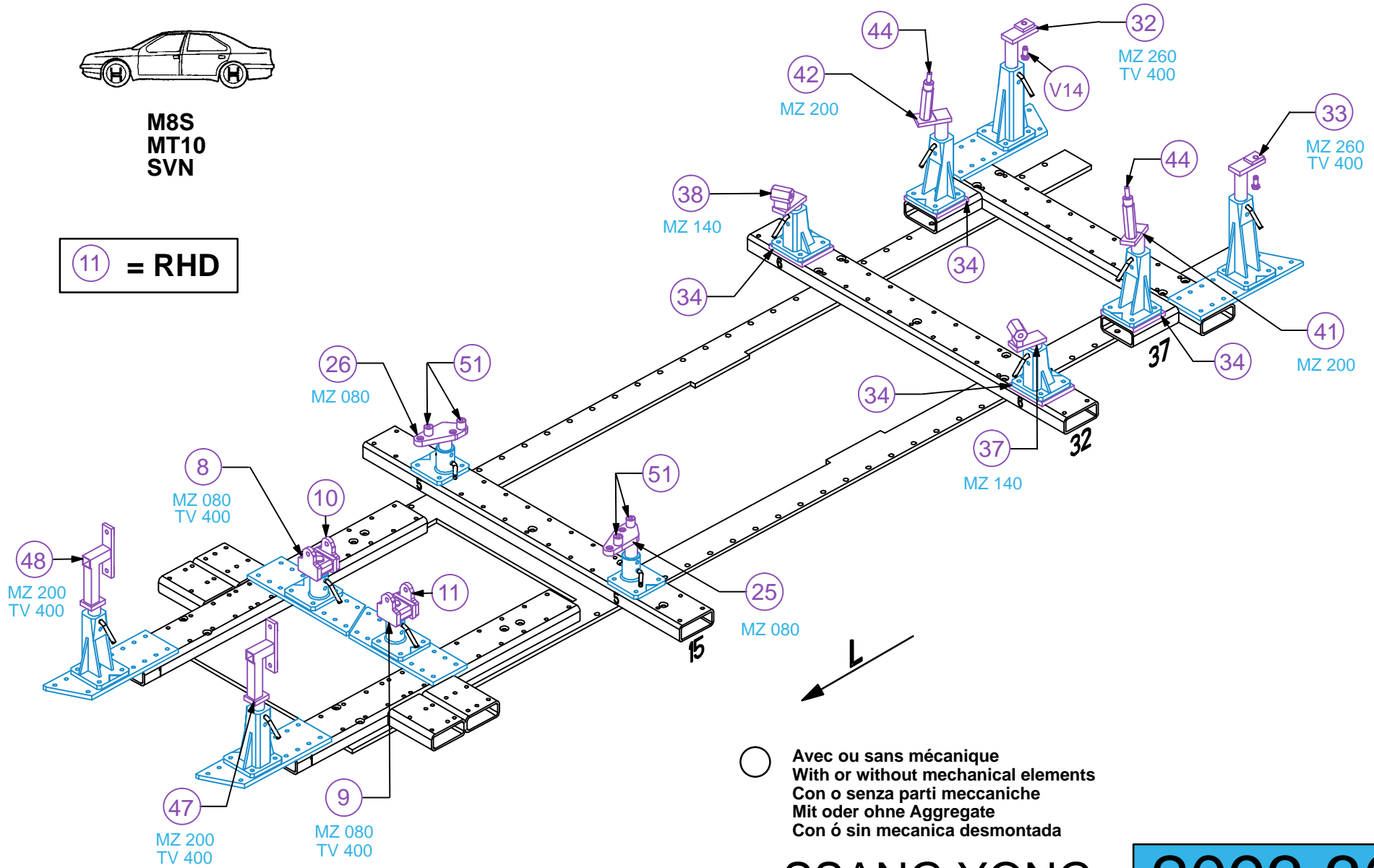

○ Avec ou sans mécanique  
With or without mechanical elements  
Con o senza parti meccaniche  
Mit oder ohne Aggregate  
Con ó sin mecánica desmontada

**SSANG YONG**

<b>2093.300</b>		
115 Kg	29.06.2006	456-D-5R

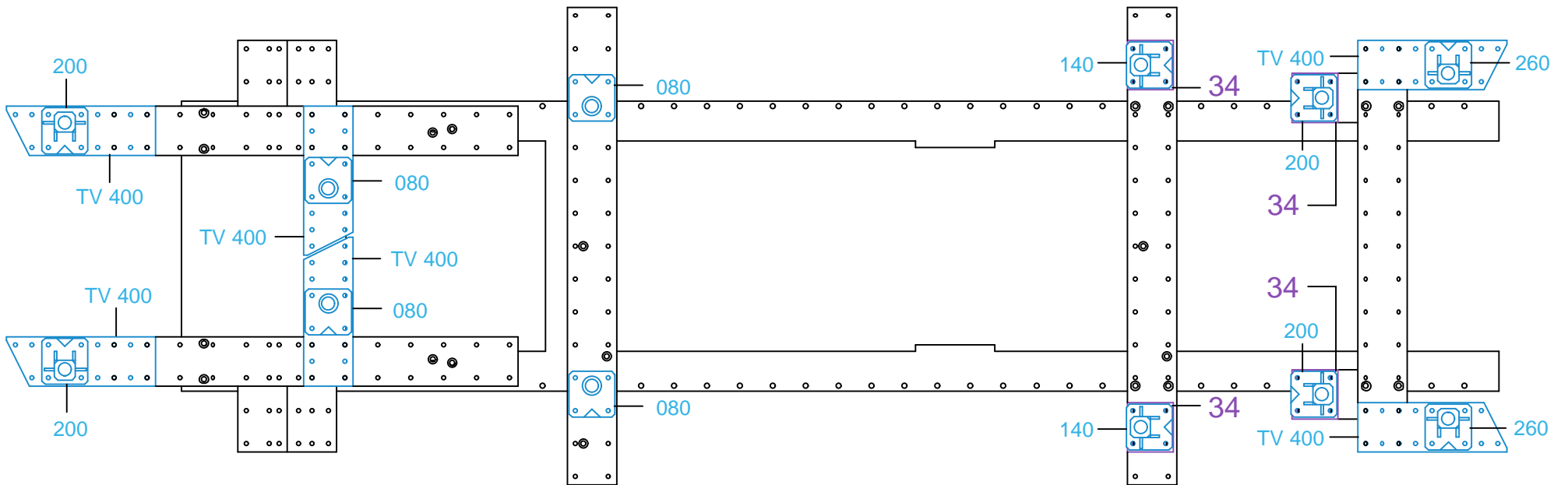

1 2 3 4 5 6 7 8 9 10 11 12 13 14 15 16 17 18 19 20 21 22 23 24 25 26 27 28 29 30 31 32 33 34 35 36 37 38 39 40 41

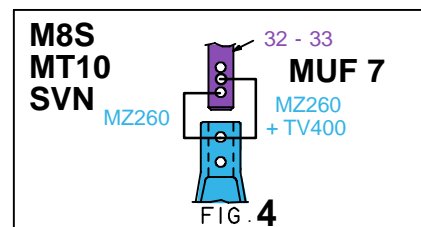
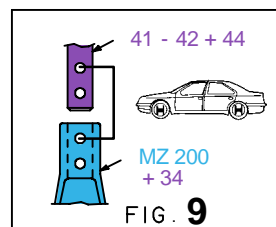
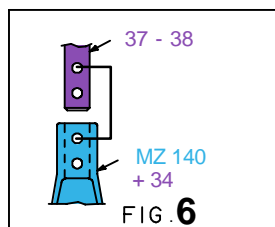
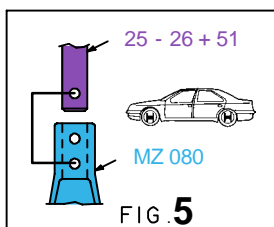



**M8S  
MT10  
SVN**

**11 = RHD**

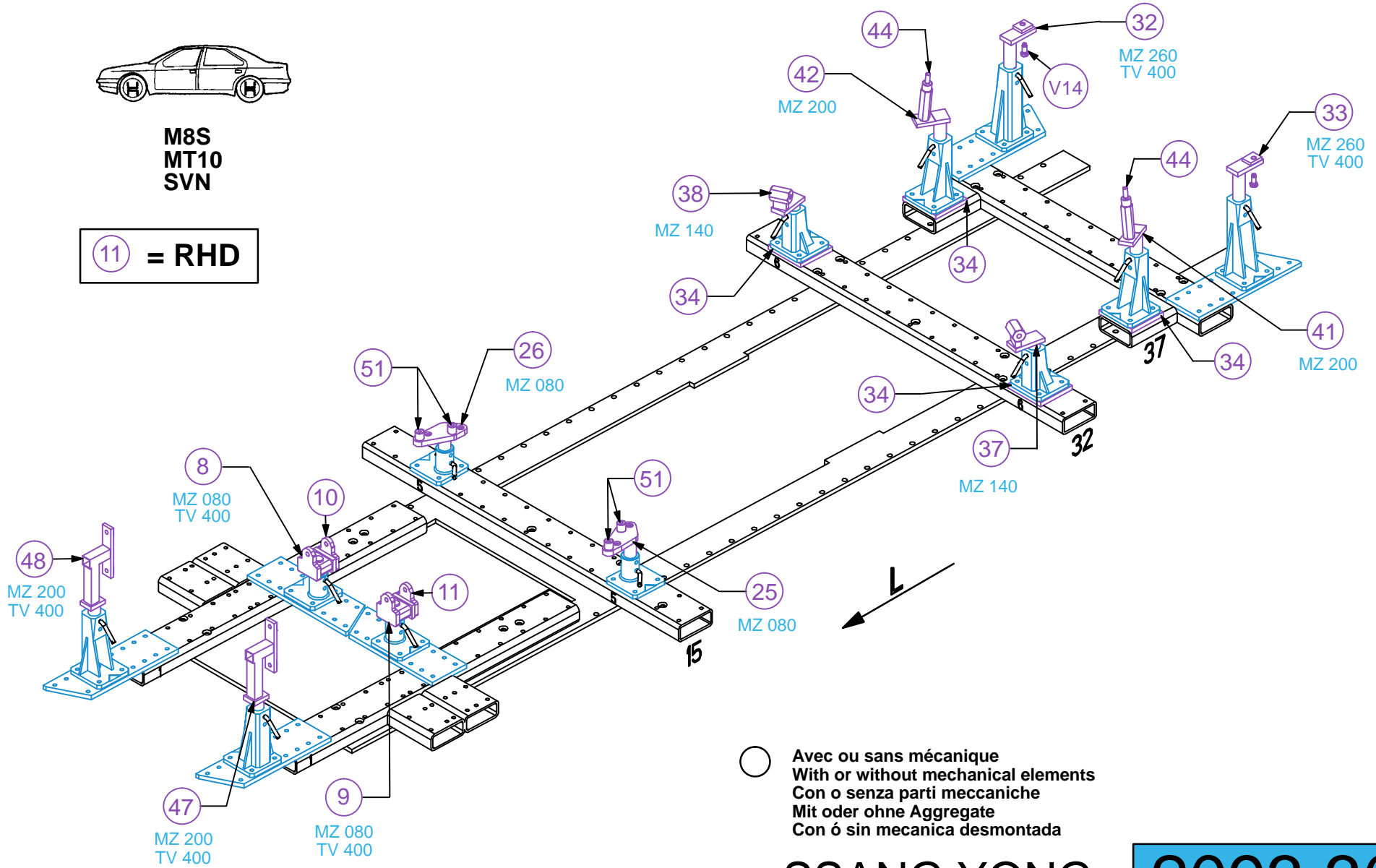

**SSANG YONG**

**2093.300**

115 Kg    29.06.2006    456-D-5S

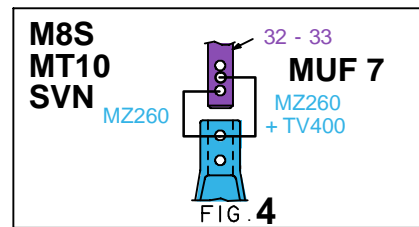
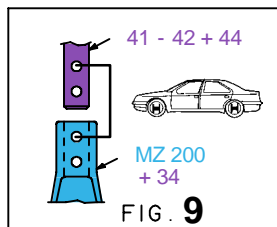
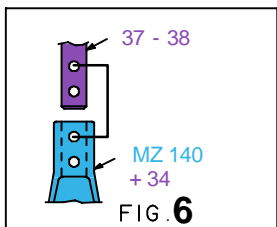
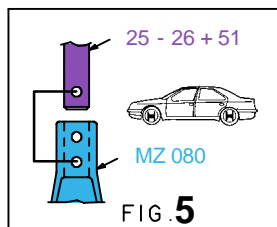
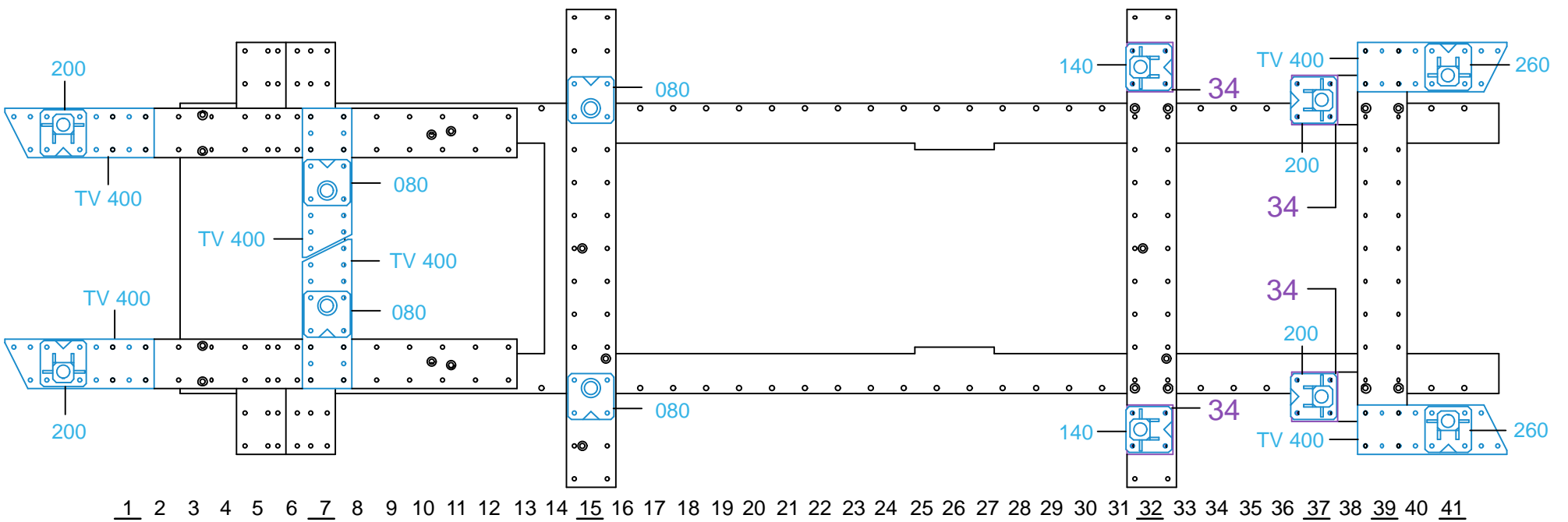

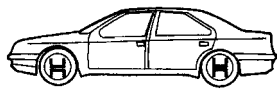

M8S  
MT10  
SVN

11 = RHD

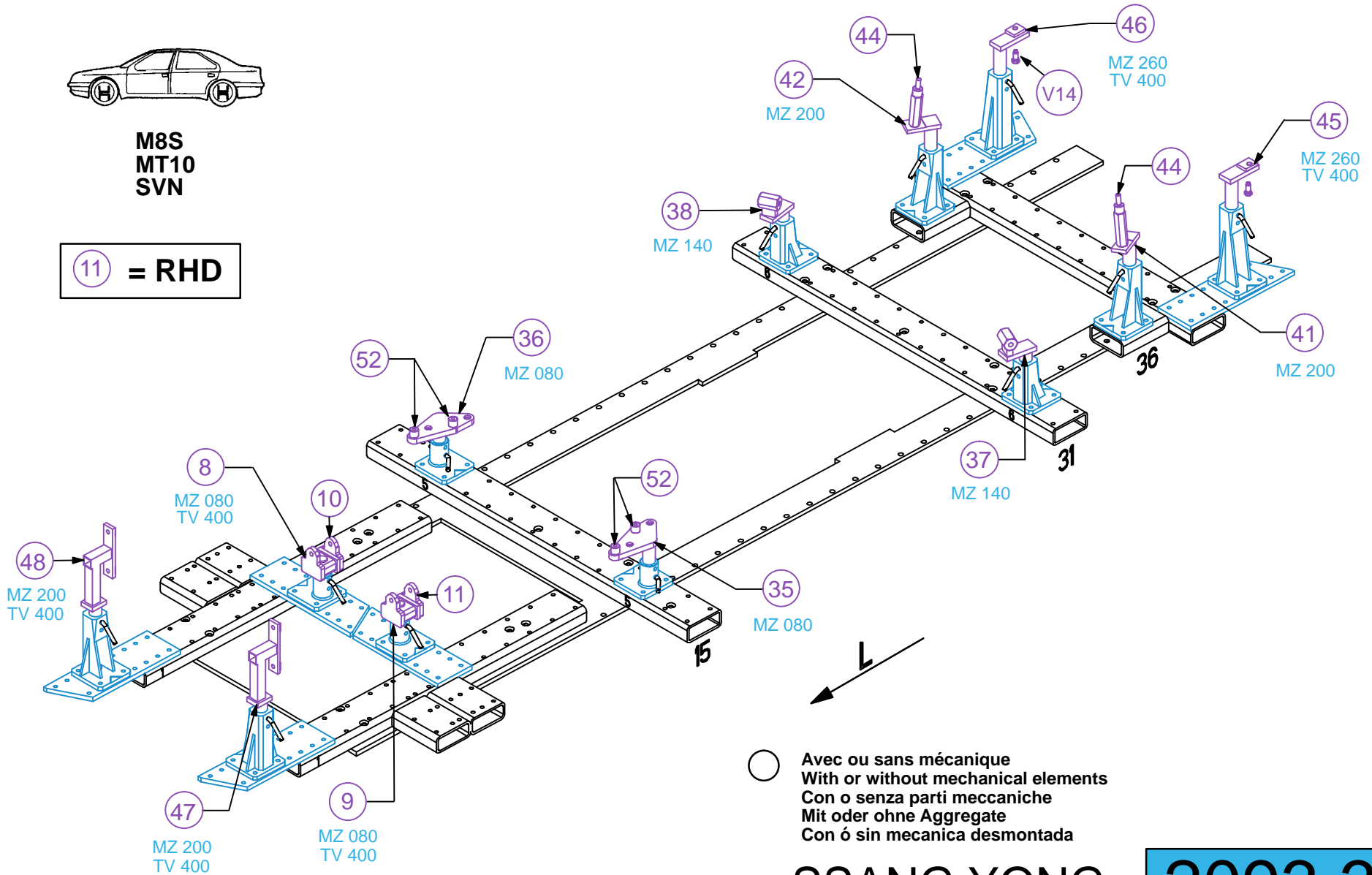

○ Avec ou sans mécanique  
With or without mechanical elements  
Con o senza parti meccaniche  
Mit oder ohne Aggregate  
Con ó sin mecanica desmontada

**SSANG YONG**

<b>2093.300</b>		
115 Kg	29.06.2006	456-D-5T

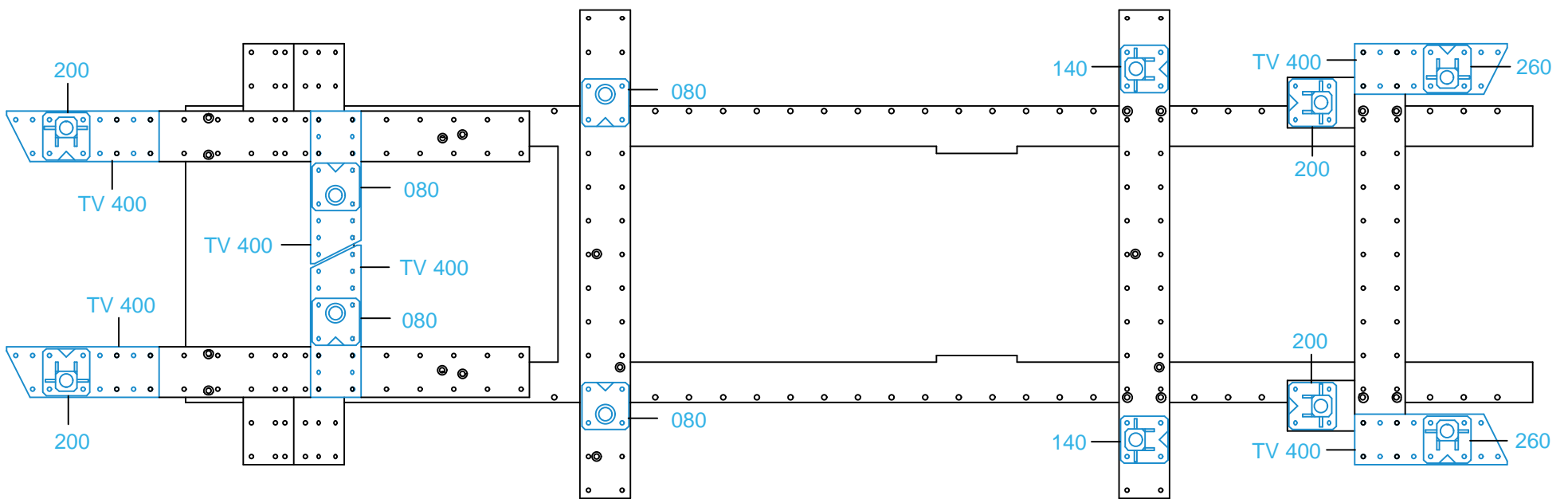

1 2 3 4 5 6 7 8 9 10 11 12 13 14 15 16 17 18 19 20 21 22 23 24 25 26 27 28 29 30 31 32 33 34 35 36 37 38 39 40 41

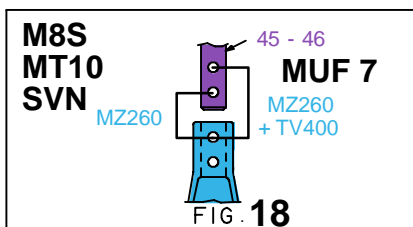
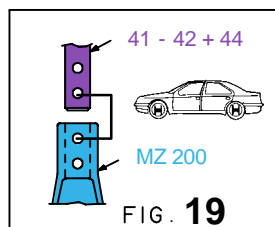
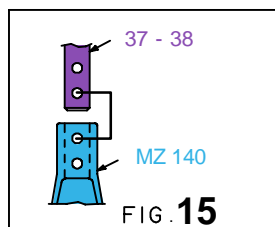
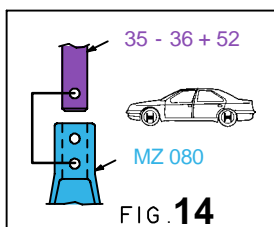

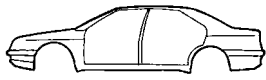

**M8S  
MT10  
SVN**

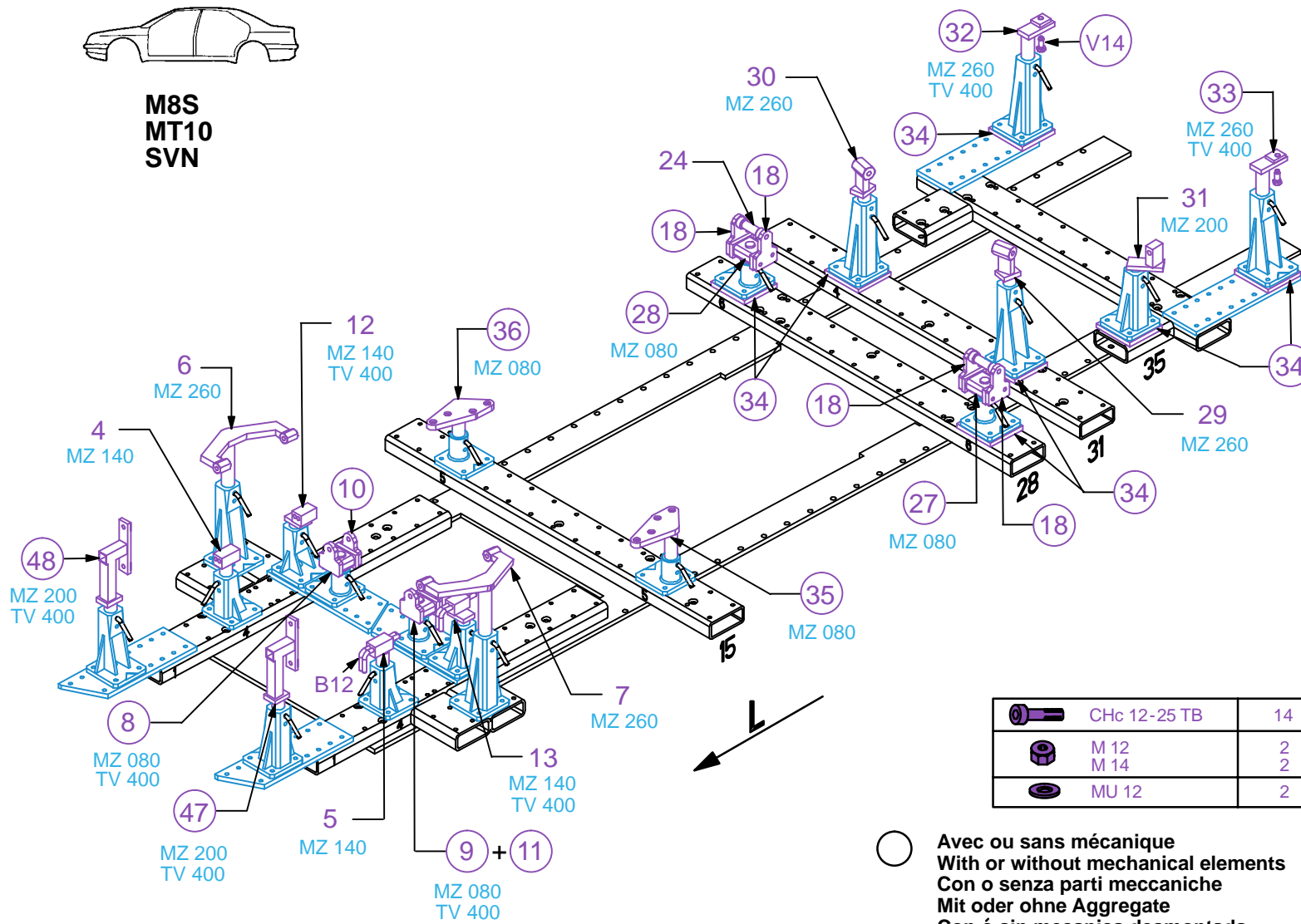

○ Avec ou sans mécanique  
With or without mechanical elements  
Con o senza parti meccaniche  
Mit oder ohne Aggregate  
Con ó sin mecanica desmontada

**SSANG YONG**

REP.	REFERENCE	PDS	NB	MZ
4	2016.7004	1,9	1	140
5	2016.7005	1,9	1	140
6	2016.7006	5,2	1	260
7	2016.7007	5,2	1	260
8	2016.7008	2,6	1	080
9	2016.7009	2,6	1	080
10	2016.7010	0,7	1	
11	2016.7011	0,7	1	
12	2016.7012	2,0	1	140
13	2016.7013	2,0	1	140
18	2016.7018	0,9	4	
22	2016.7022	2,4	1	260
23	2016.7023	2,4	1	260
24	2016.7024	0,1	2	
25	2016.7025	3,0	1	080
26	2016.7026	3,0	1	080
27	2016.7027	2,6	1	080
28	2016.7028	2,6	1	080
29	2016.7029	2,5	1	260
30	2016.7030	2,5	1	260
31	2016.7031	2,3	1	200
32	2016.7032	2,5	1	260
33	2016.7033	2,5	1	260
34	2016.7034	2,4	7	
35	2016.7035	3,8	1	080
36	2016.7036	3,8	1	080
37	2016.7037	2,6	1	140
38	2016.7038	2,6	1	140
39	2016.7039	2,0	1	260
40	2016.7040	2,0	1	260
41	2016.7041	2,0	1	200
42	2016.7042	2,0	1	200
43	2016.7043	1,0	2	
44	2016.7044	1,0	2	
45	2016.7045	2,4	1	260
46	2016.7046	2,4	1	260
47	2016.7047	2,8	1	200
48	2016.7048	2,8	1	200
49	2016.7049	0,2	2	
50	2016.7050	0,2	2	
51	2016.7051	0,1	4	
52	2016.7052	0,1	4	
	V14	0,1	2	
	B12	0,2	8	

M 12-20	2
M 12-25	14
M 12-30	16
M 12-50	2
M 14-120	2
M 14-160	1
M 10x1,25-40	4
M 10x1,25-70	4
M 12x1,25-40	4
M 14x1,50-60	2

**2093.300**

115 Kg    29.06.2006    456-D-5U

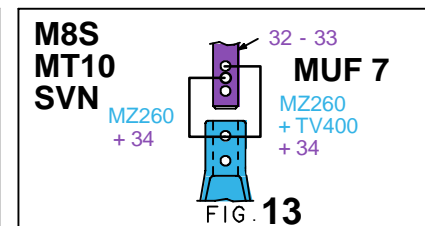
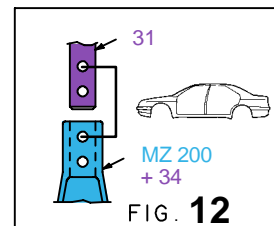
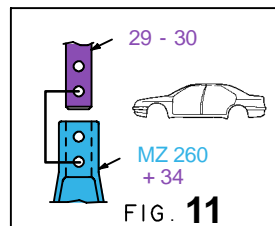
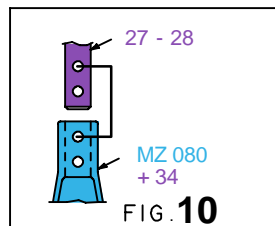
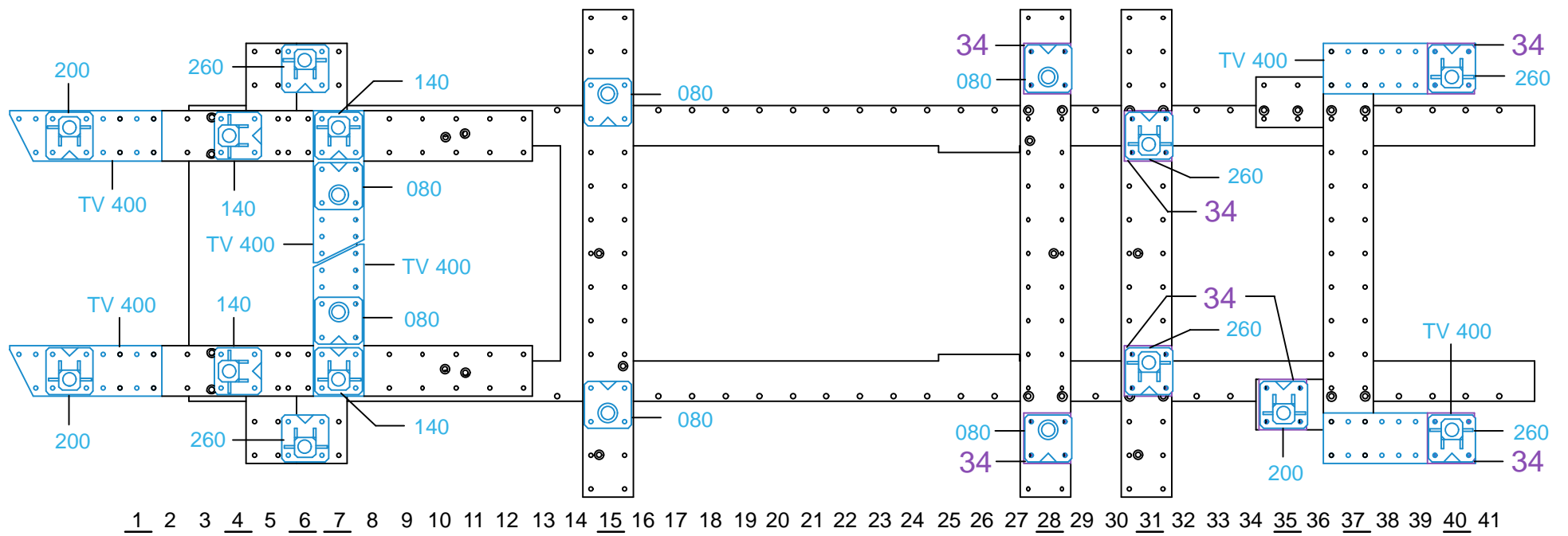

2093.300-RVA3-4 00

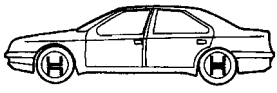

**M8S  
MT10  
SVN**

**11 = RHD**

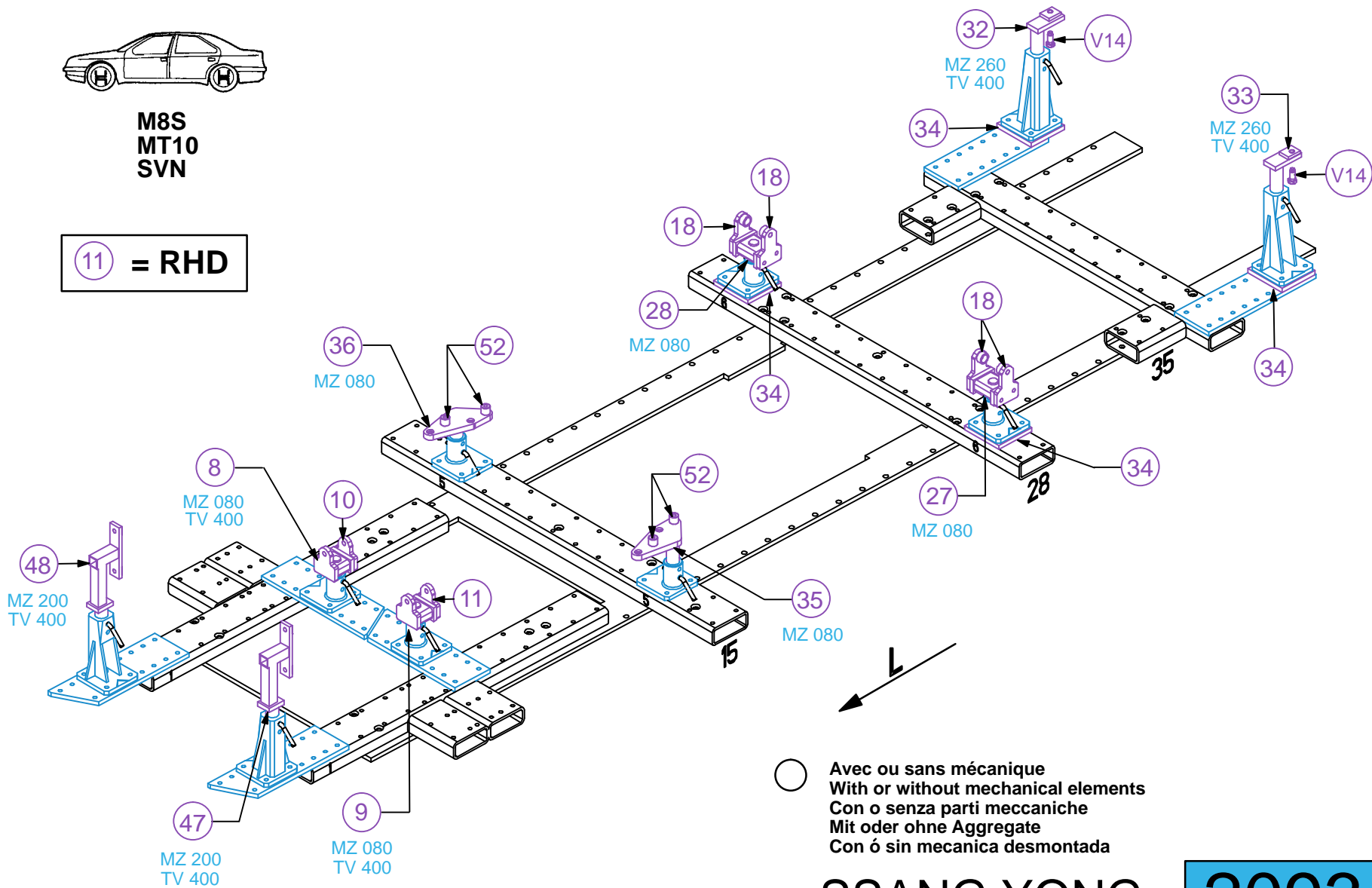

**SSANG YONG**

<b>2093.300</b>		
115 Kg	29.06.2006	456-D-5V

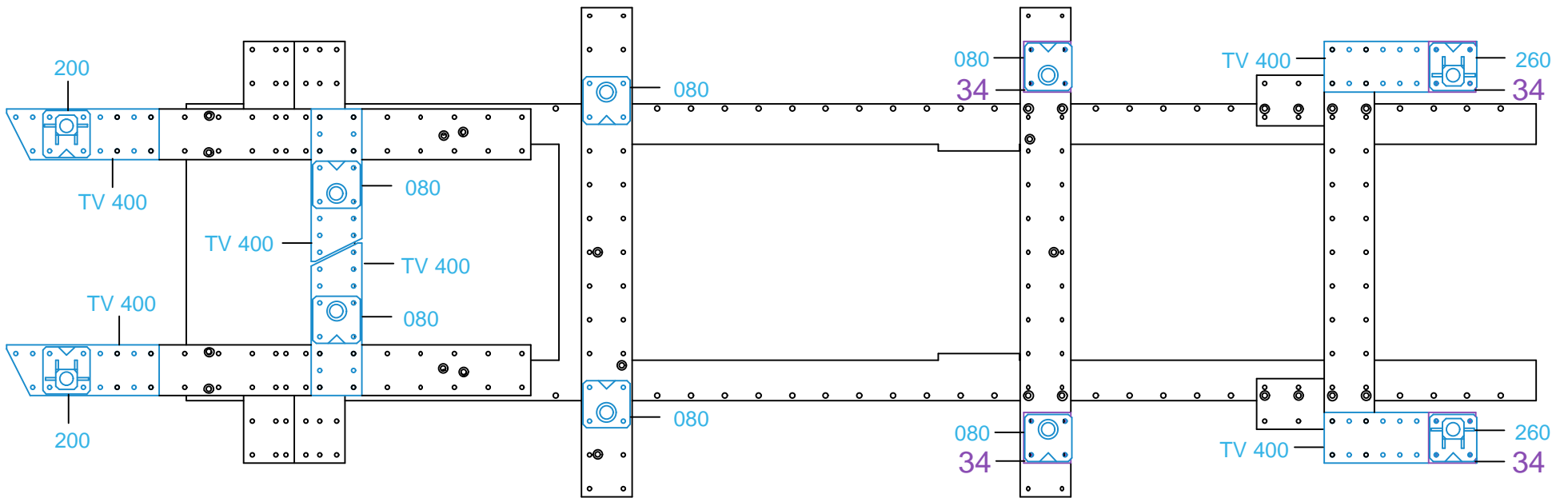

1 2 3 4 5 6 7 8 9 10 11 12 13 14 15 16 17 18 19 20 21 22 23 24 25 26 27 28 29 30 31 32 33 34 35 36 37 38 39 40 41

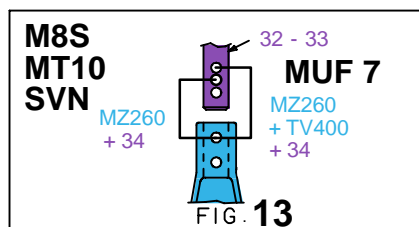
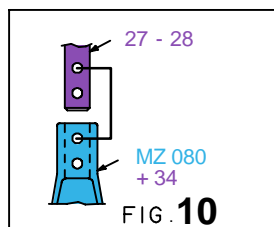
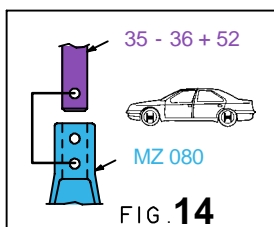



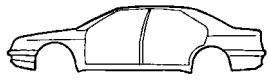

**M8S  
MT10  
SVN**

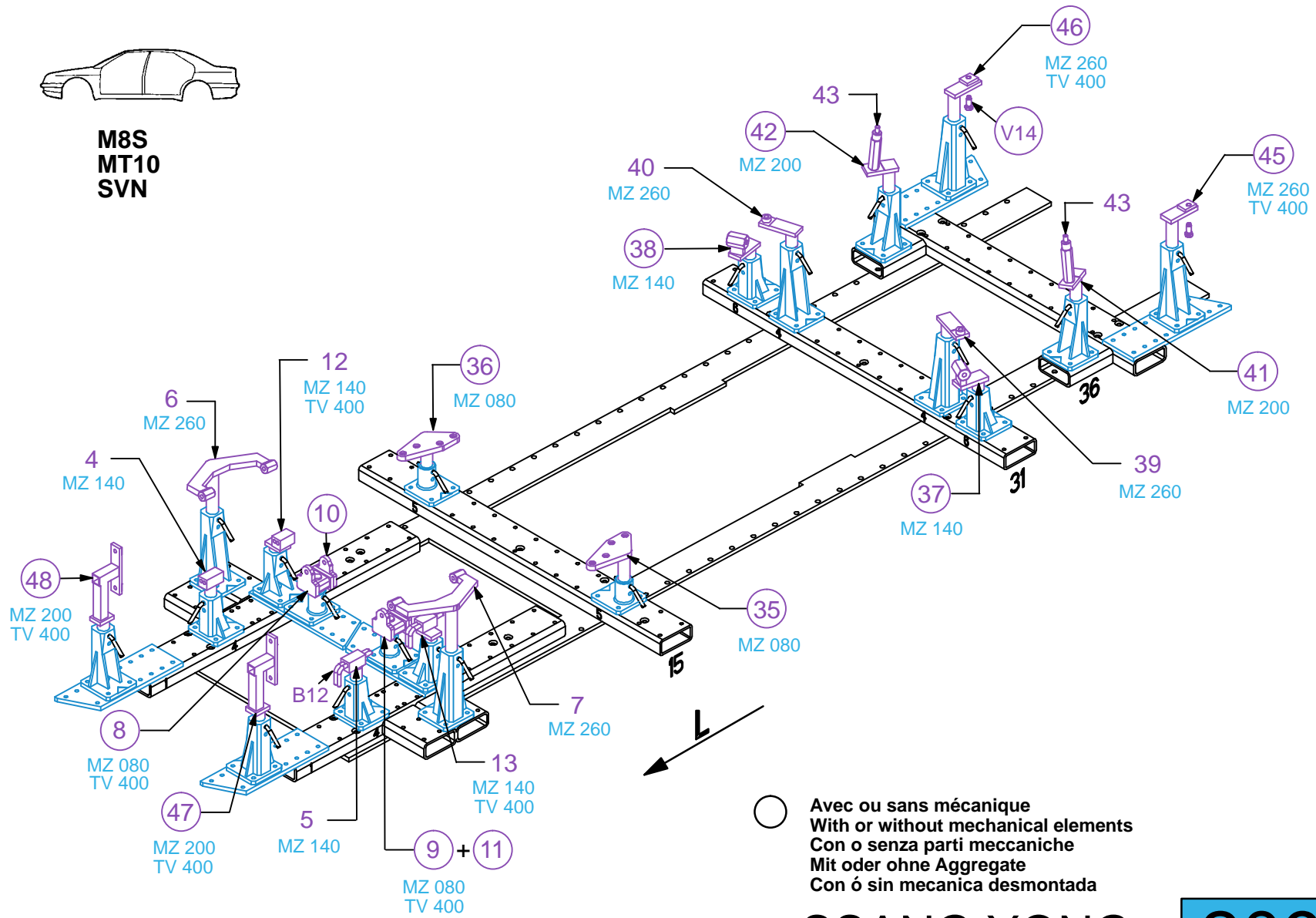

**SSANG YONG**

<b>2093.300</b>		
115 Kg	31.05.2006	456-D-5W

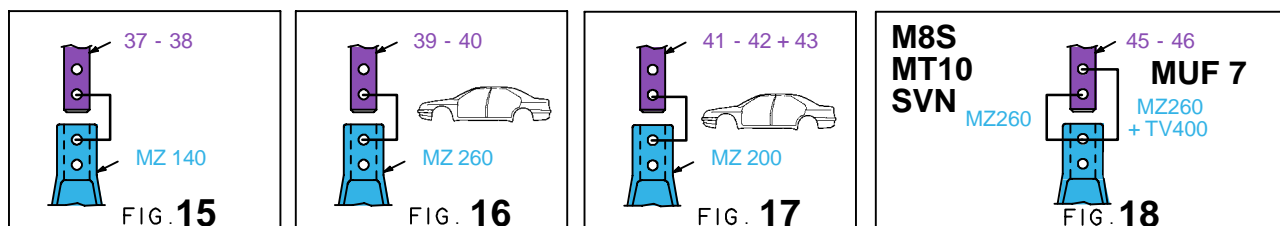
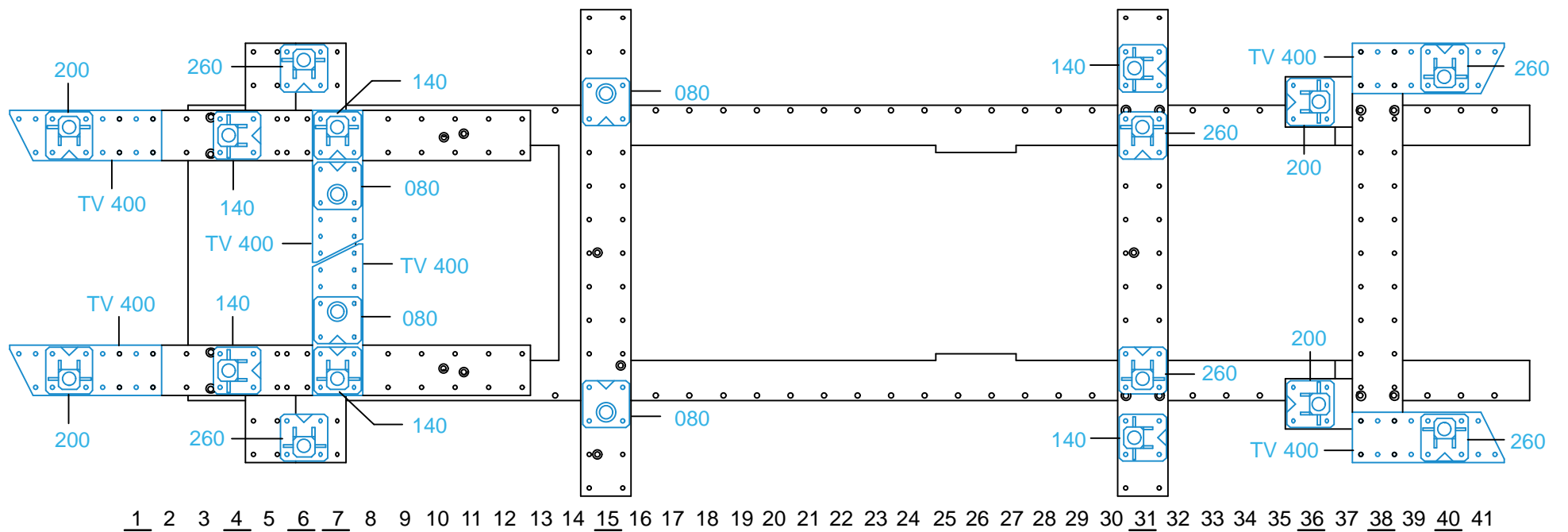

2093.300-RVA3-5 00



M8S  
MT10  
SVN

11 = RHD

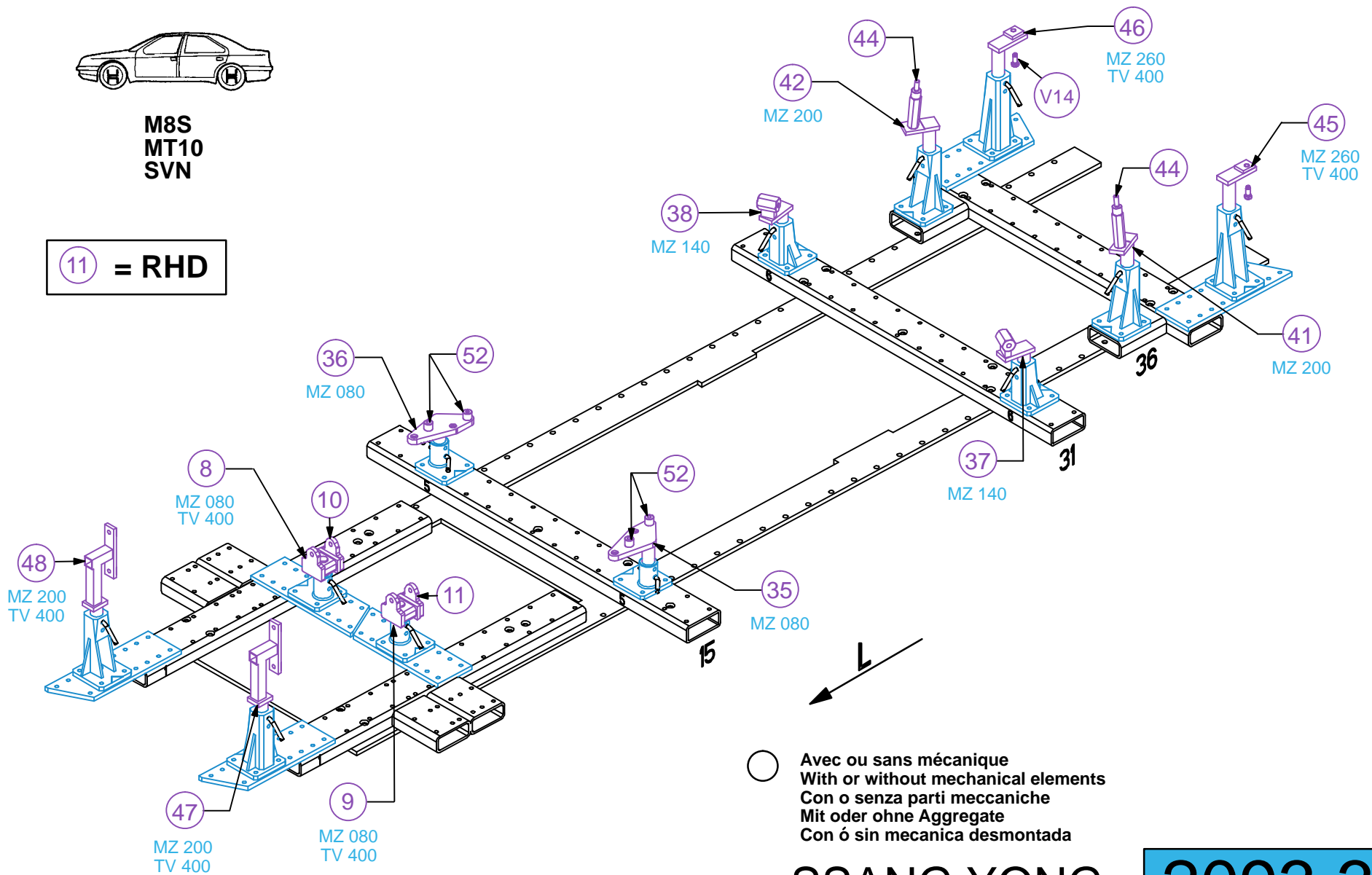

○ Avec ou sans mécanique  
With or without mechanical elements  
Con o senza parti meccaniche  
Mit oder ohne Aggregate  
Con ó sin mecanica desmontada

**SSANG YONG**

<b>2093.300</b>		
115 Kg	29.06.2006	456-D-5X

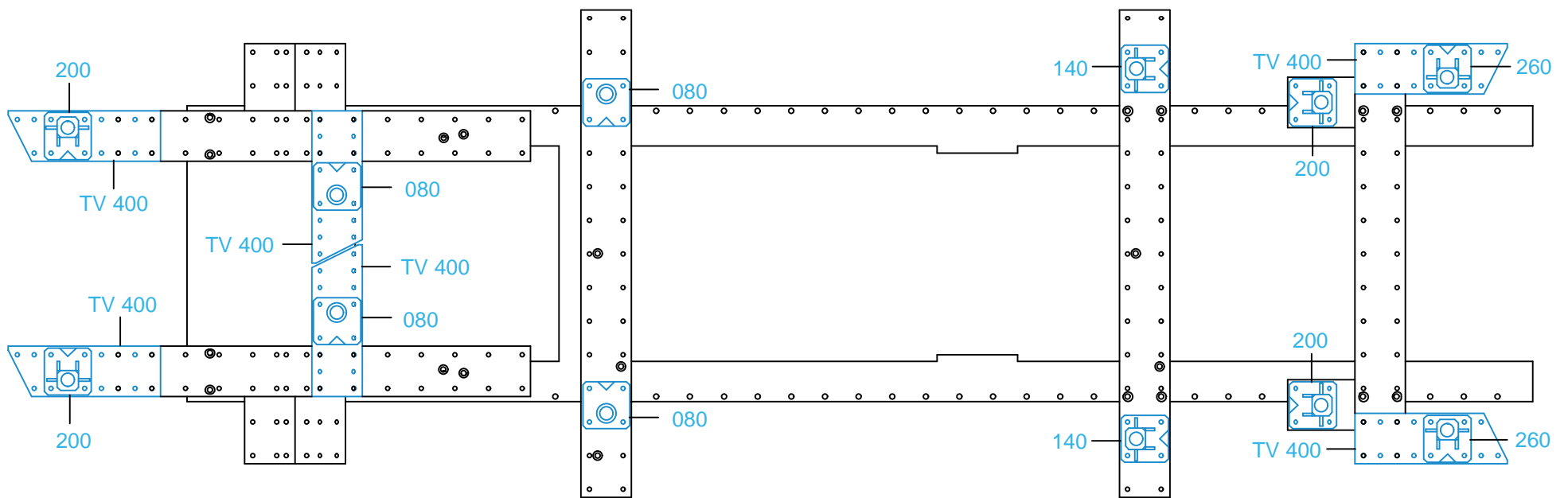

1 2 3 4 5 6 7 8 9 10 11 12 13 14 15 16 17 18 19 20 21 22 23 24 25 26 27 28 29 30 31 32 33 34 35 36 37 38 39 40 41

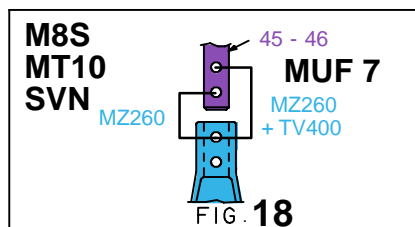
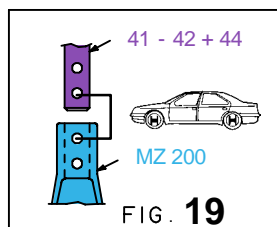
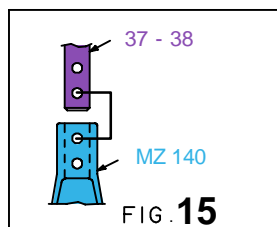
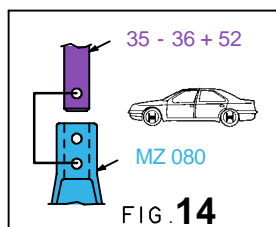

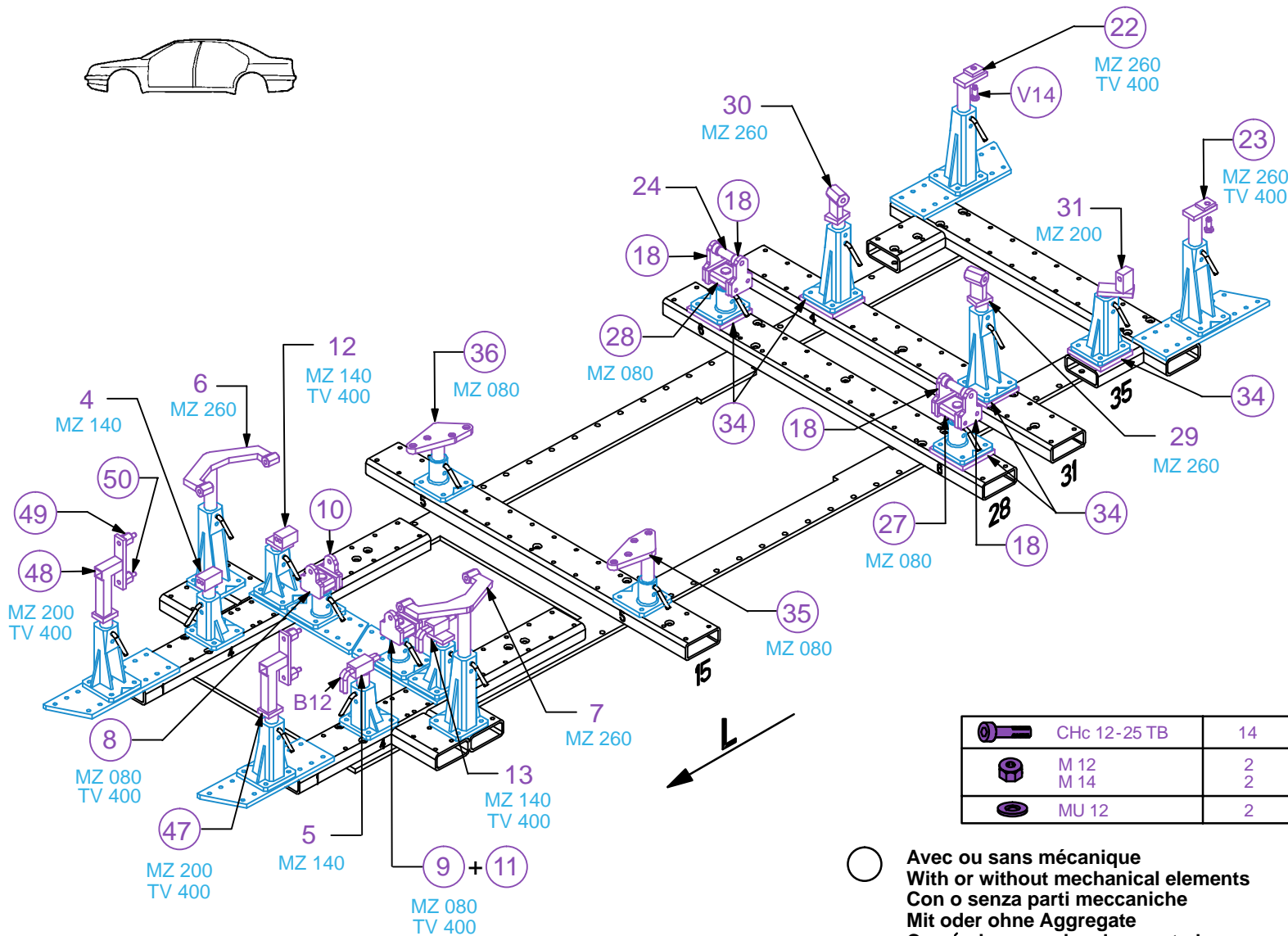
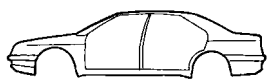

	CHc 12-25 TB	14
	M 12 M 14	2
	MU 12	2

○ Avec ou sans mécanique  
 With or without mechanical elements  
 Con o senza parti meccaniche  
 Mit oder ohne Aggregate  
 Con ó sin mecanica desmontada

REP.	REFERENCE	PDS	NB	MZ
4	2016.7004	1,9	1	140
5	2016.7005	1,9	1	140
6	2016.7006	5,2	1	260
7	2016.7007	5,2	1	260
8	2016.7008	2,6	1	080
9	2016.7009	2,6	1	080
10	2016.7010	0,7	1	
11	2016.7011	0,7	1	
12	2016.7012	2,0	1	140
13	2016.7013	2,0	1	140
18	2016.7018	0,9	4	
22	2016.7022	2,4	1	260
23	2016.7023	2,4	1	260
24	2016.7024	0,1	2	
25	2016.7025	3,0	1	080
26	2016.7026	3,0	1	080
27	2016.7027	2,6	1	080
28	2016.7028	2,6	1	080
29	2016.7029	2,5	1	260
30	2016.7030	2,5	1	260
31	2016.7031	2,3	1	200
32	2016.7032	2,5	1	260
33	2016.7033	2,5	1	260
34	2016.7034	2,4	7	
35	2016.7035	3,8	1	080
36	2016.7036	3,8	1	080
37	2016.7037	2,6	1	140
38	2016.7038	2,6	1	140
39	2016.7039	2,0	1	260
40	2016.7040	2,0	1	260
41	2016.7041	2,0	1	200
42	2016.7042	2,0	1	200
43	2016.7043	1,0	2	
44	2016.7044	1,0	2	
45	2016.7045	2,4	1	260
46	2016.7046	2,4	1	260
47	2016.7047	2,8	1	200
48	2016.7048	2,8	1	200
49	2016.7049	0,2	2	
50	2016.7050	0,2	2	
51	2016.7051	0,1	4	
52	2016.7052	0,1	4	
	V14	0,1	2	
	B12	0,2	8	

	M 12-20	2
	M 12-25	14
	M 12-30	16
	M 12-50	2
	M 14-120	2
	M 14-160	1
	M 10x1,25-40	4
	M 10x1,25-70	4
	M 12x1,25-40	4
	M 14x1,50-60	2

**SSANG YONG**

**2093.300**

115 Kg    29.06.2006    456-D-5Y

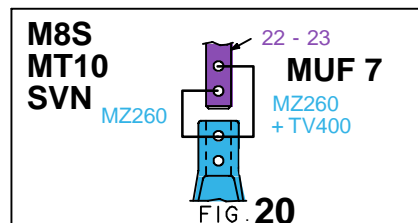
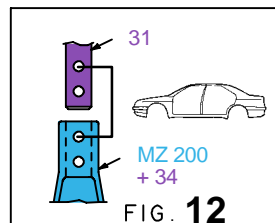
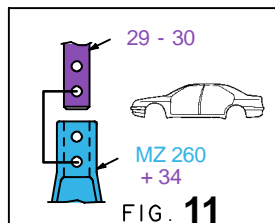
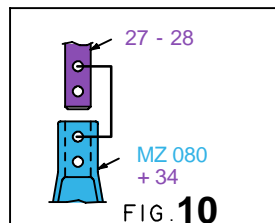
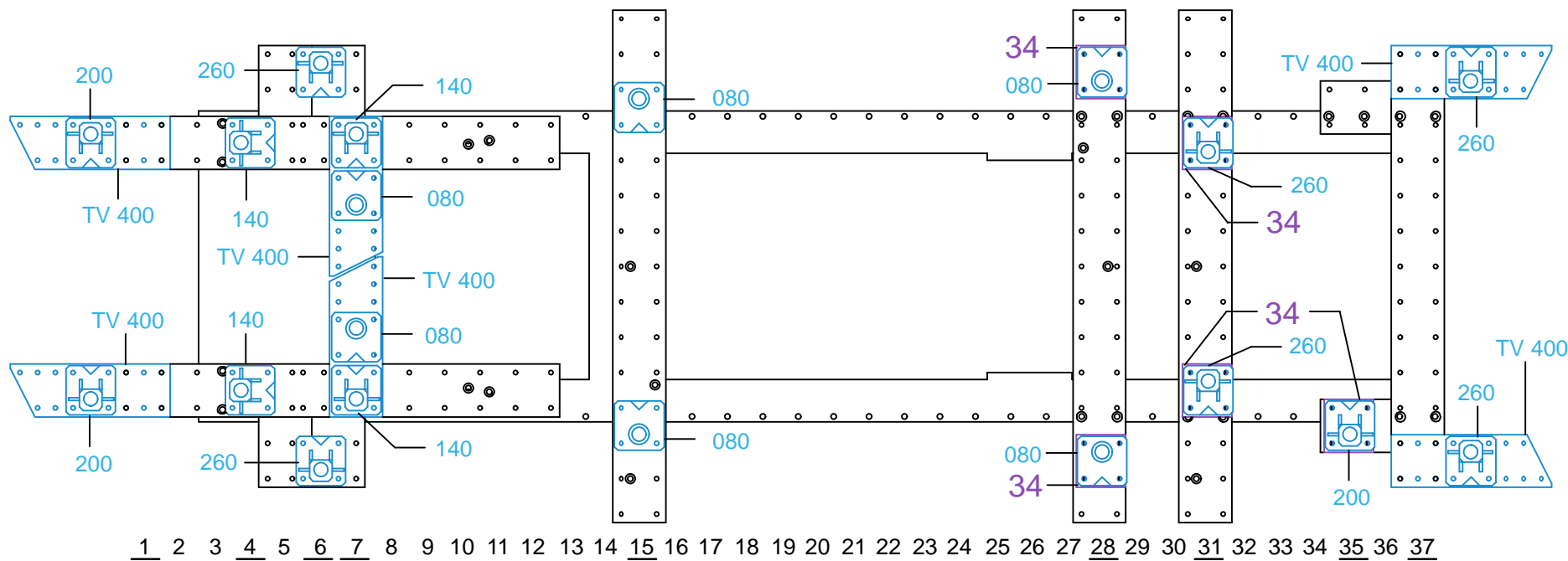

2093.300-RVA3-6 00

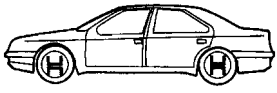

11 = RHD

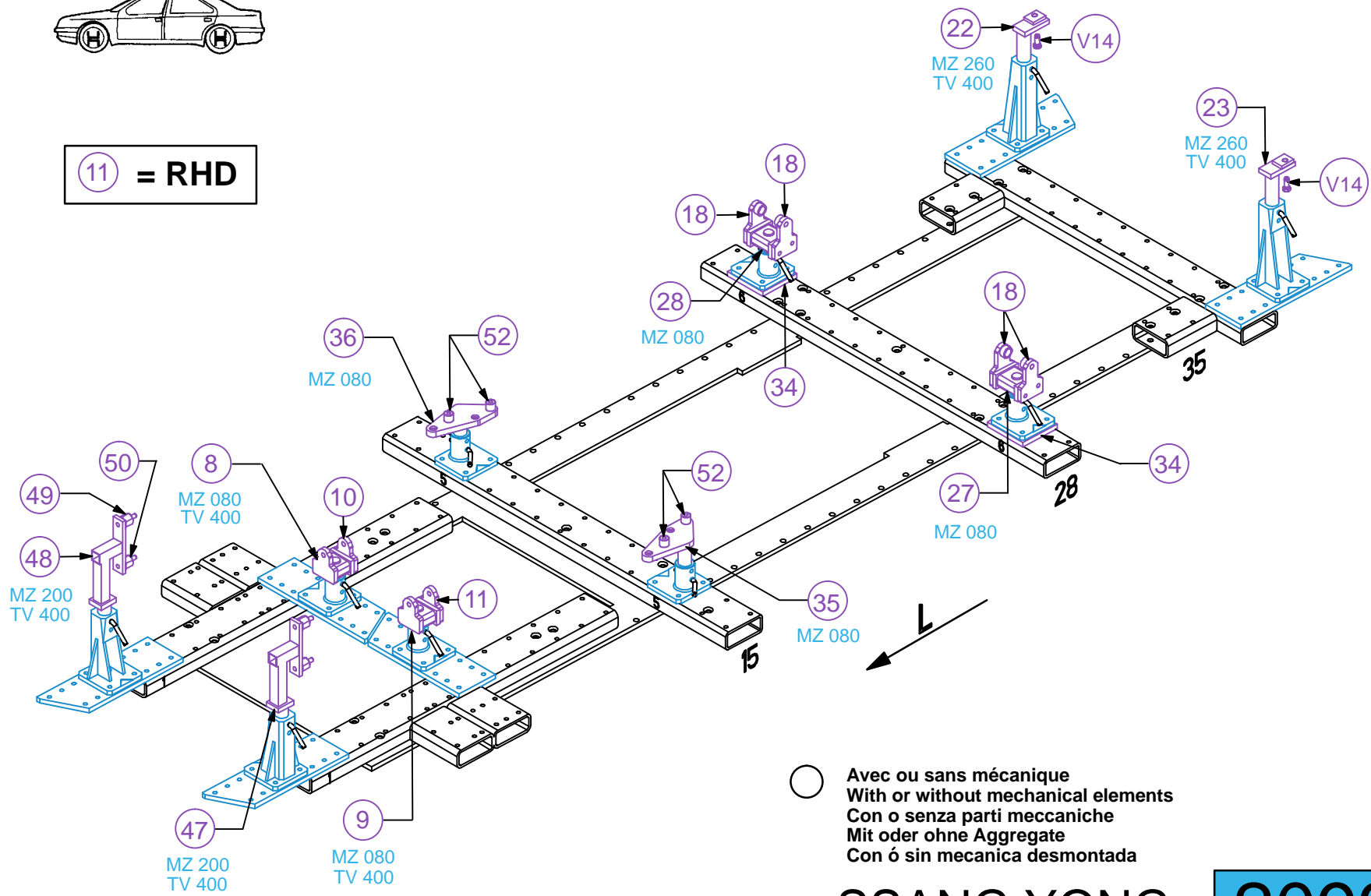

**SSANG YONG**

**2093.300**

115 Kg | 29.06.2006 | 456-D-5Z

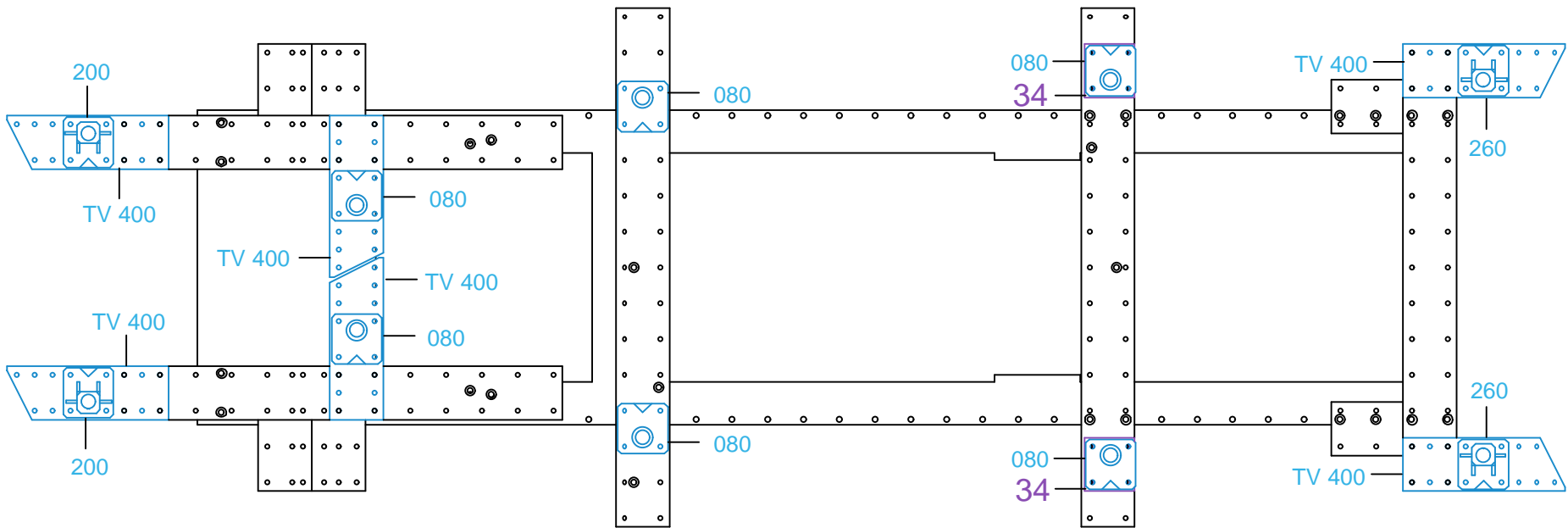

1 2 3 4 5 6 7 8 9 10 11 12 13 14 15 16 17 18 19 20 21 22 23 24 25 26 27 28 29 30 31 32 33 34 35 36 37

