

REP.	REFERENCE	PDS	NB	MZ
1	2092.7001	2,9	1	142
2	2092.7002	2,9	1	141
3	2092.7003	1,6	1	140/080
4	2092.7004	1,6	1	140/080
5	2092.7005	2,9	1	601
6	2092.7006	2,9	1	602
7	2092.7007	0,5	2	
8	2092.7008	1,8	1	200
9	2092.7009	1,8	1	200
10	2092.7010	1,9	1	140/080
11	2092.7011	1,9	1	140/080
12	2092.7012	1,3	1	080
13	2092.7013	1,3	1	080
14	2092.7014	2,9	1	080
15	2092.7015	2,9	1	080
16	2092.7016	2,4	1	260
17	2092.7017	2,4	1	260
18	2092.7018	2,0	1	602
19	2092.7019	2,0	1	601
20	2092.7020	0,2	2	
21	2092.7021	1,6	1	080
22	2092.7022	1,6	1	080
23	2092.7023	2,0	1	260
24	2092.7024	2,0	1	260

M 8-25	4
M 12-25	2
M 12x1,25-35	2
M 12x1,25-70	4
M 12x1,25-160	2
M 12x1,25-170	2
M 12x1,25-180	2
M 14x1,50-180	4

○ Avec ou sans mécanique  
With or without mechanical elements  
Con o senza parti meccaniche  
Mit oder ohne Aggregate  
Con ó sin mecanica desmontada

**HONDA**

**2092.300**

50 Kg 11.07.2006 413-D-42A

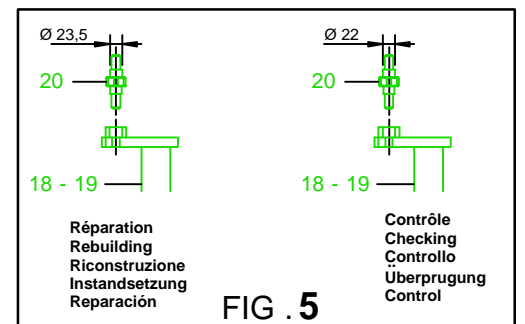
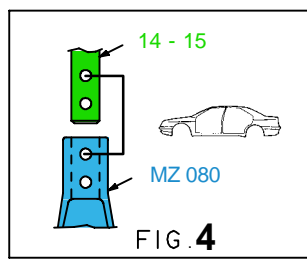
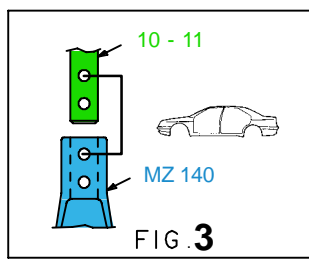
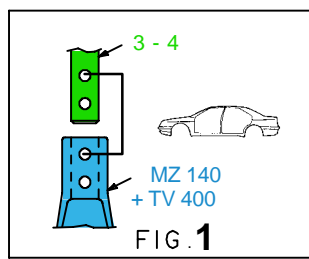
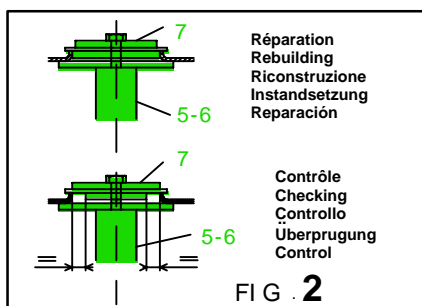
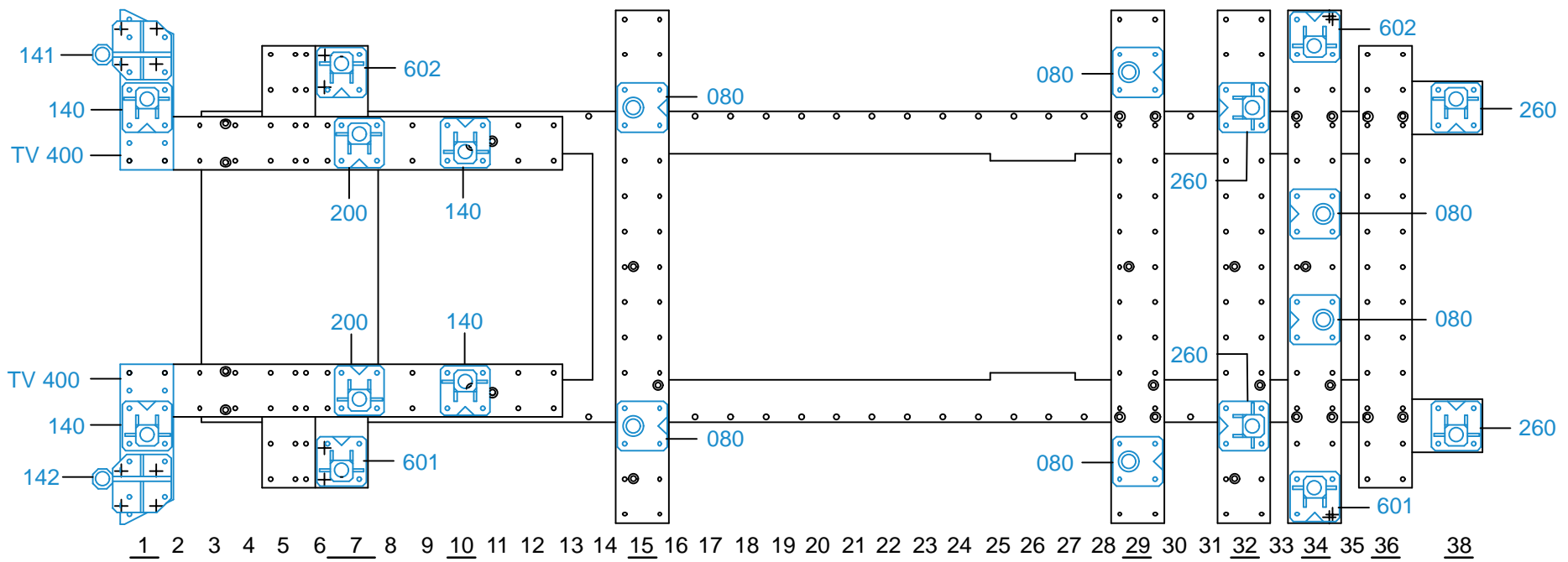

2092.300-RVA3-1 00

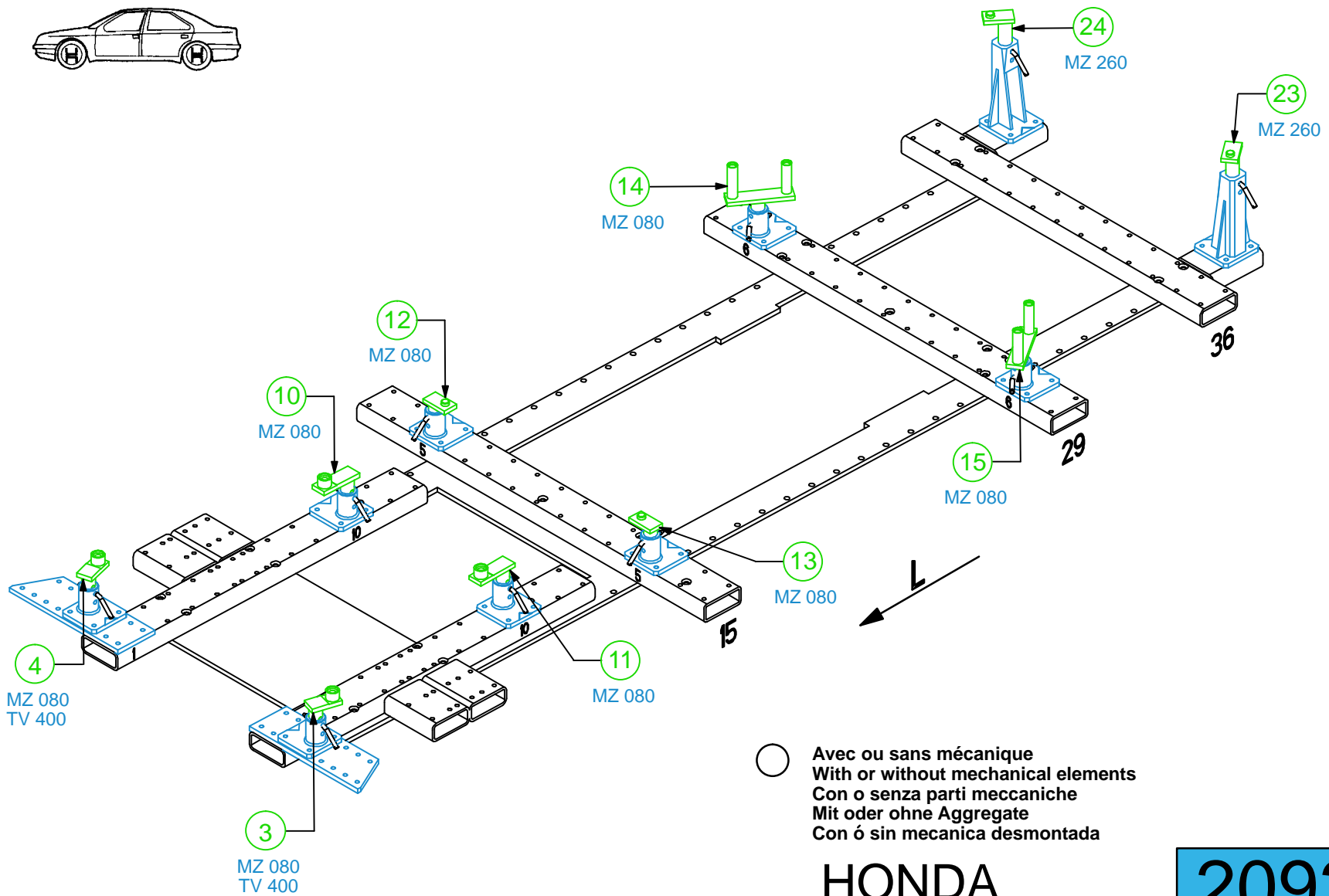
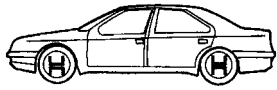

**HONDA**

<b>2092.300</b>		
50 Kg	11.07.2006	413-D-42B

