

**VAS 6384**



○ Avec ou sans mécanique  
With or without mechanical elements  
Con o senza parti meccaniche  
Mit oder ohne Aggregate  
Con ó sin mecanica desmontada

REP.	REFERENCE	PDS	NB	MZ
1	2091.7001	3,4	1	141
2	2091.7002	3,4	1	142
3	2091.7003	0,3	2	
4	2091.7004	2,7	1	
5	2091.7005	2,7	1	
6	2091.7006	3,1	1	260
7	2091.7007	2,5	1	260
8	2091.7008	1,8	1	602
9	2091.7009	1,8	1	601
10	2091.7010	1,2	1	
11	2091.7011	1,6	1	260/080
12	2091.7012	1,6	1	260/080
13	2091.7013	0,8	2	
14	2091.7014	3,1	1	140/080
15	2091.7015	3,1	1	140/080
16	2091.7016	0,1	2	
17	2091.7017	6,4	1	
18	2091.7018	6,4	1	
19	2091.7019	0,8	2	
20	2091.7020	2,6	1	140
21	2091.7021	2,6	1	080
22	2091.7022	2,6	1	080
23	2091.7023	1,1	1	
24	2091.7024	1,1	1	
25	2091.7025	0,1	2	
26	2091.7026	2,7	1	200
27	2091.7027	2,7	1	200
28	2091.7028	2,2	1	602
29	2091.7029	2,2	1	601
30	2091.7030	2,0	1	260/200
31	2091.7031	2,0	1	260/200
32	2091.7032	2,6	1	200
33	2091.7033	2,6	1	200
34	2091.7034 B76	1,2	1	
		0,1	2	

M 8-25	12
M 8-30	2
M 10-20	2
M 10-25	8
M 10-30	4
M 10-55	4
M 12-20	2
M 12-25	8
M 12x1,50-30	4
M 12x1,50-60	2
M 12x1,50-70	4
M 12x1,50-120	2
M 12x1,50-130	2
M 12x1,50-140	2
M 12x1,50-160	2
M 8	2
M 10	4
MU 12	2

**2091.300**

83 Kg    26.06.2006    403-D-20A

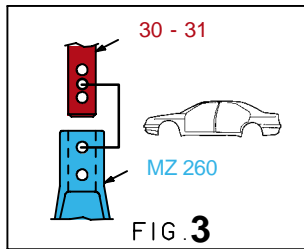
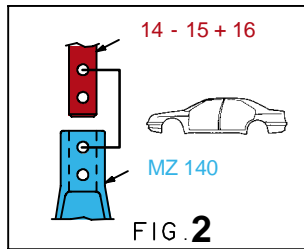
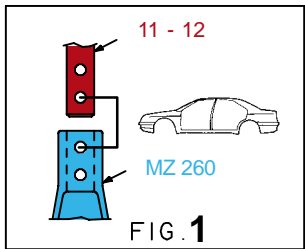
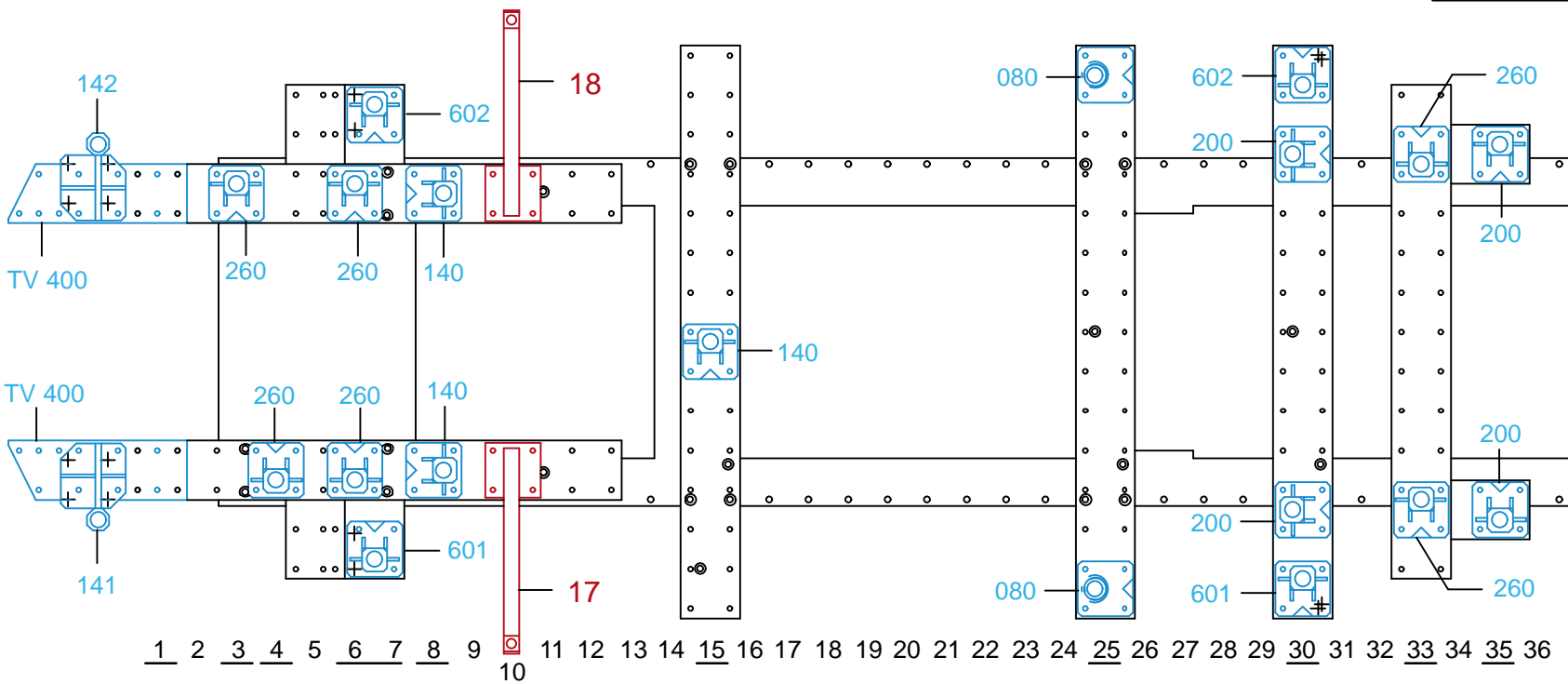

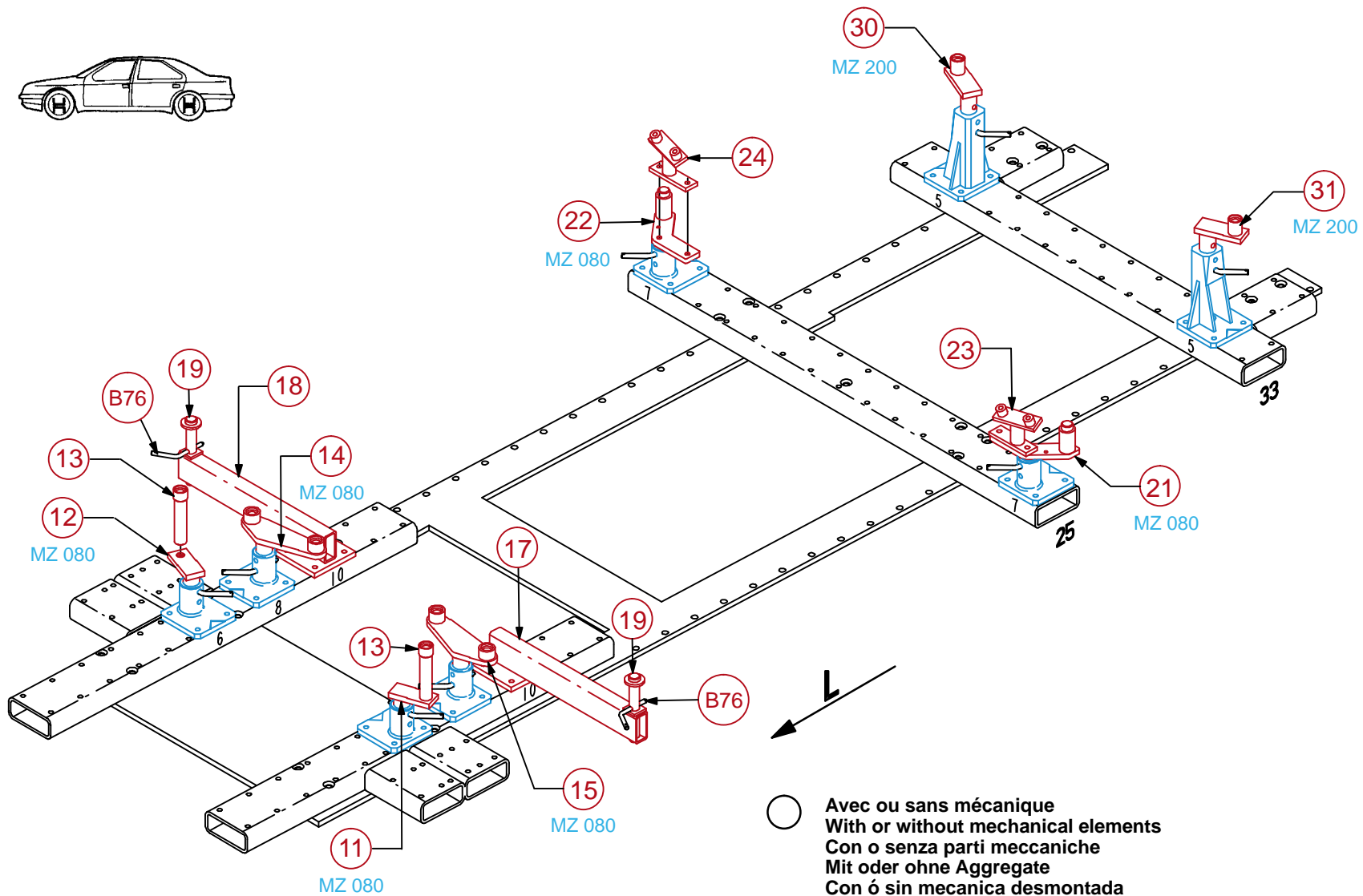
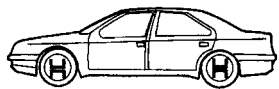

**VAS 6384**



**2091.300**

83 Kg 26.06.2006 403-D-20B

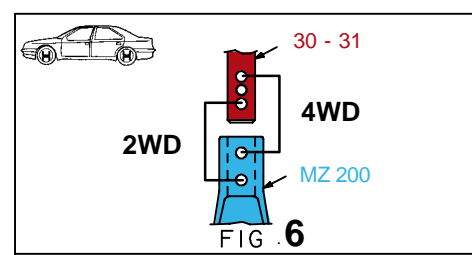
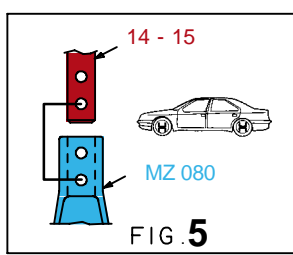
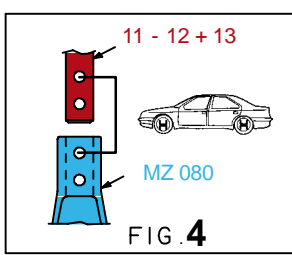
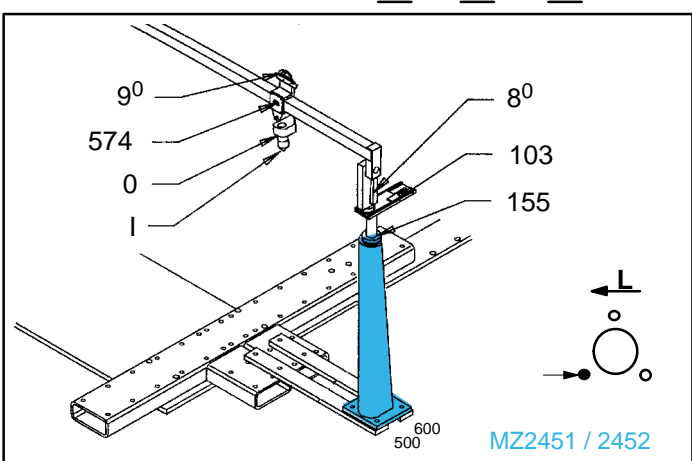
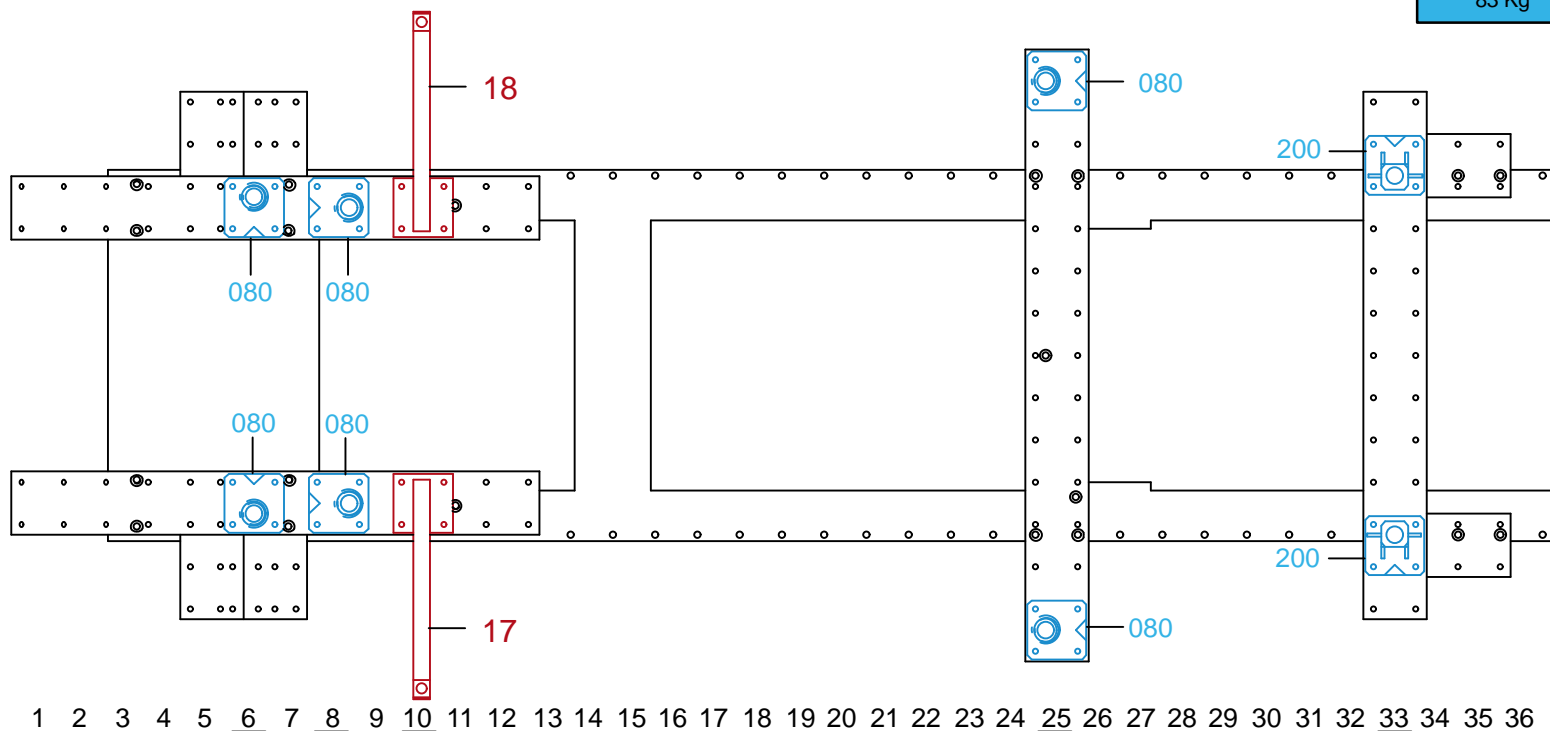

2091.300-RVA3-1 00