

REP.	REFERENCE	PDS	NB	MZ
42	2087.7042	4,8	2	140
43	2087.7043	2,8	2	140
44	2087.7044	2,6	1	
45	2087.7045	2,6	1	
46	2087.7046	0,1	4	

- M 10-35
- M 10-70
- TFHc 16-60
- 955714

complément au
complementary set to
complemento al
zusatz zu

2087.300

2087.308

22,5 Kg 25.07.2007 439-D-14E

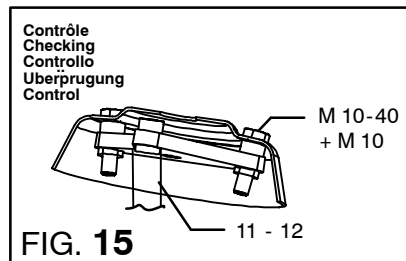

○ Avec ou sans mécanique
With or without mechanical elements
Con o senza parti meccaniche
Mit oder ohne Aggregate
Con ó sin mecanica desmontada

VOLVO

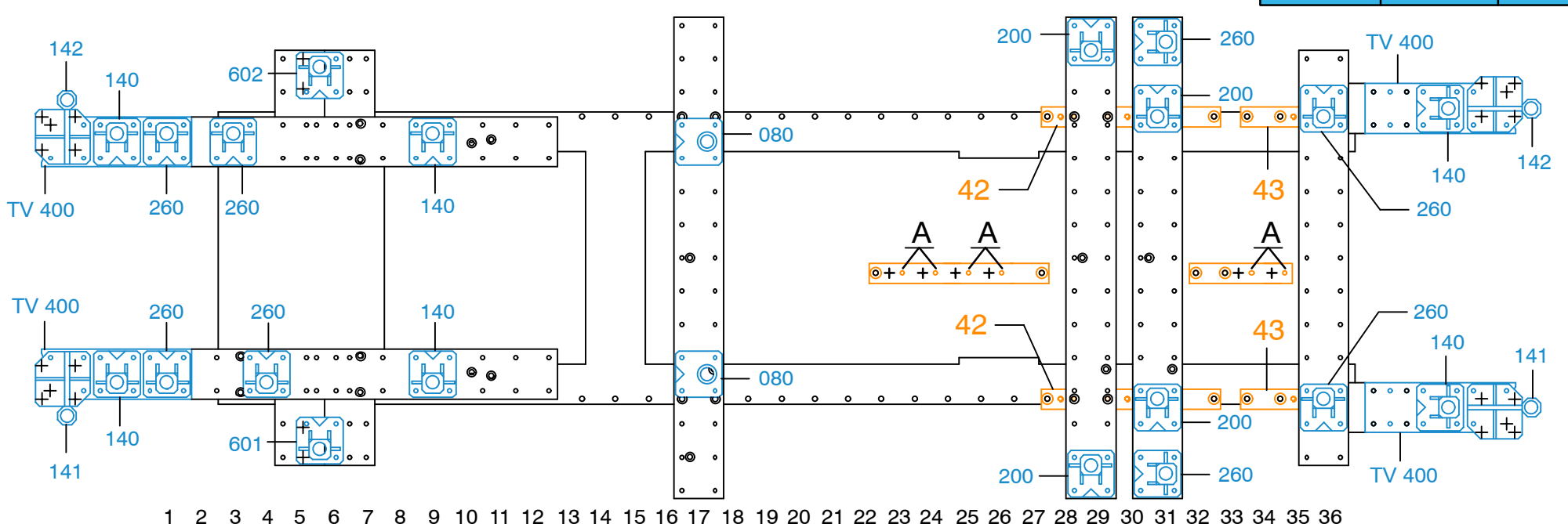

1 2 3 4 5 6 7 8 9 10 11 12 13 14 15 16 17 18 19 20 21 22 23 24 25 26 27 28 29 30 31 32 33 34 35 36

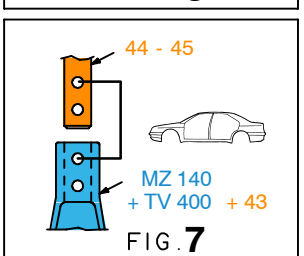
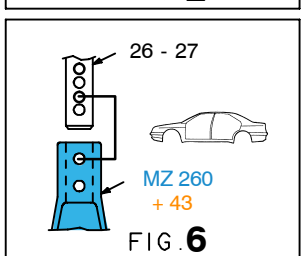
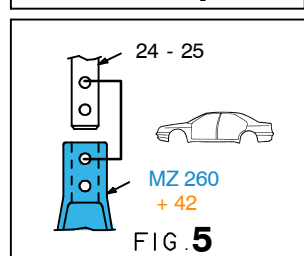
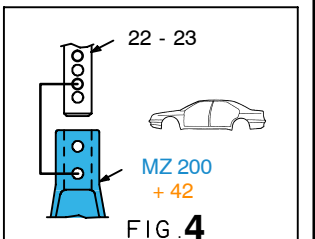
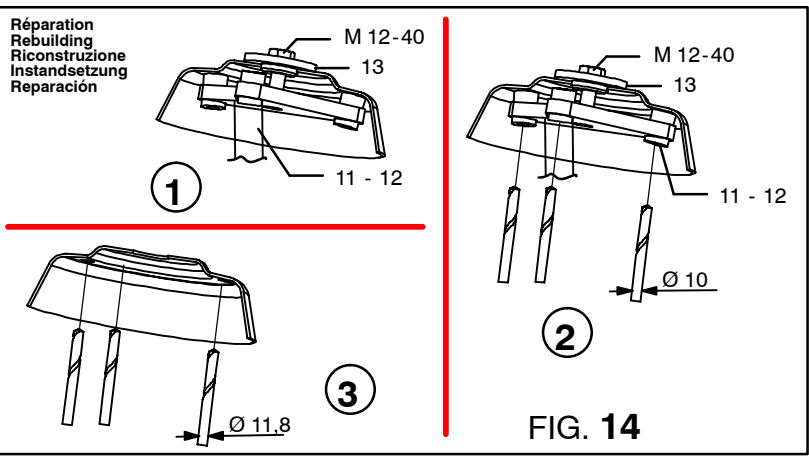
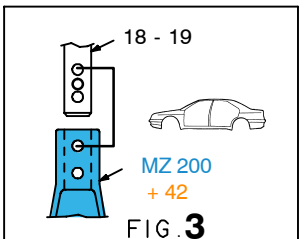
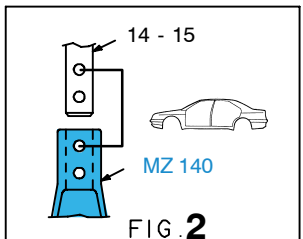
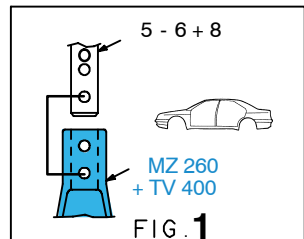

2087.308-RVA3-1 00

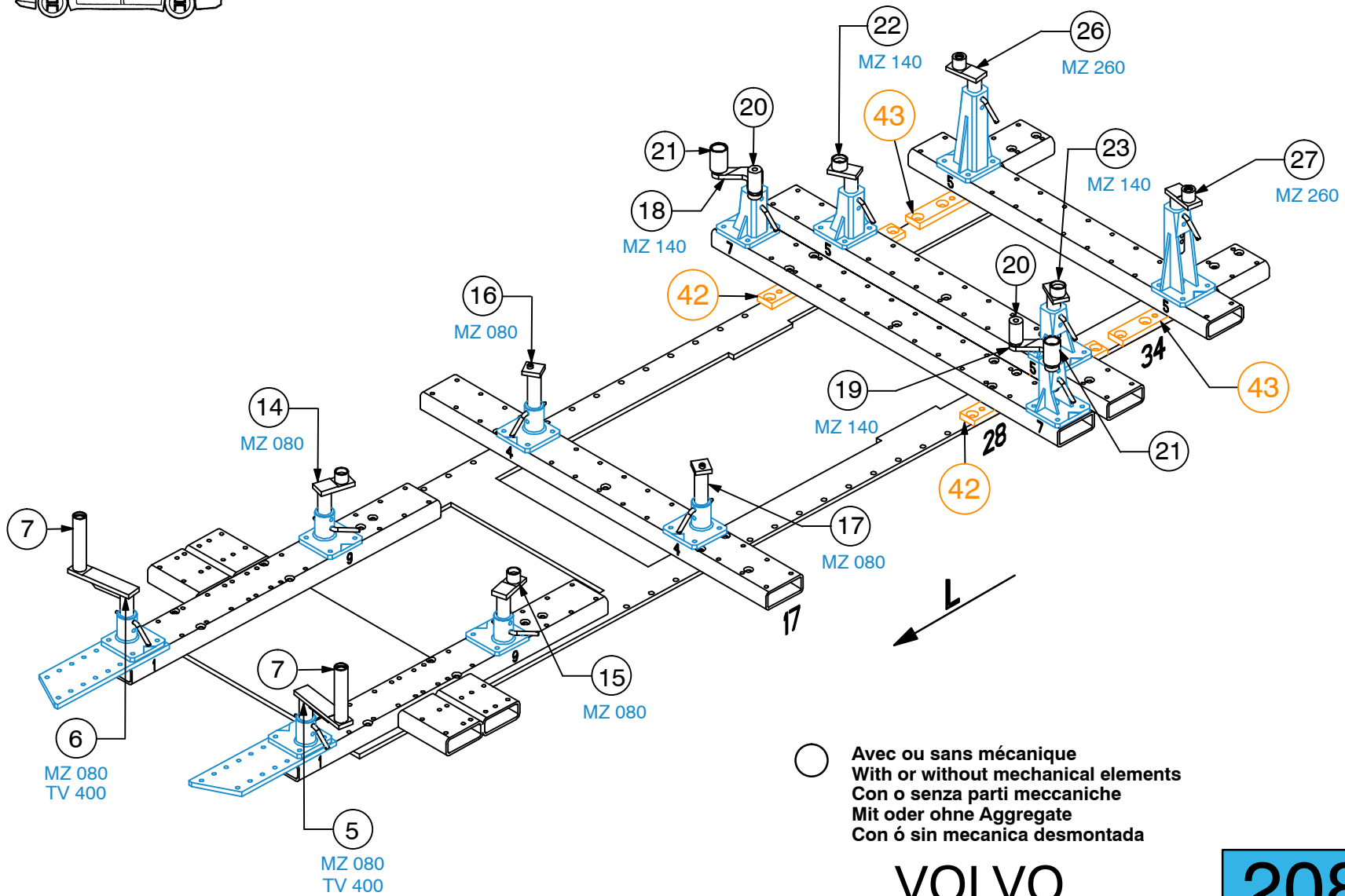
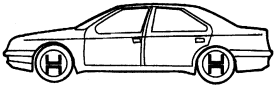

VOLVO

2087.308		
22,5 Kg	25.07.2007	439-D-14F

