

○ Avec ou sans mécanique  
With or without mechanical elements  
Con o senza parti meccaniche  
Mit oder ohne Aggregate  
Con ó sin mecanica desmontada

**VOLVO**

REP.	REFERENCE	PDS	NB	MZ
1	2087.7001	3,8	1	141
2	2087.7002	3,8	1	142
3	2087.7003	3,3	1	140
4	2087.7004	3,3	1	140
5	2087.7005	2,8	1	260/080
6	2087.7006	2,8	1	260/080
7	2087.7007	1,7	2	
8	2087.7008	0,5	2	
9	2087.7009	3,2	1	260
10	2087.7010	3,1	1	260
11	2087.7011	3,1	1	601
12	2087.7012	3,1	1	602
13	2087.7013	0,1	2	
14	2087.7014	2,1	1	140/080
15	2087.7015	2,1	1	140/080
16	2087.7016	2,1	1	080
17	2087.7017	2,1	1	080
18	2087.7018	2,5	1	200/140
19	2087.7019	2,5	1	200/140
20	2087.7020	0,6	2	
21	2087.7021	0,8	2	
22	2087.7022	2,1	1	200/140
23	2087.7023	2,1	1	200/140
24	2087.7024	3,5	1	260
25	2087.7025	3,5	1	260
26	2087.7026	2,7	1	260
27	2087.7027	2,7	1	260
28	2087.7028	2,6	1	140
29	2087.7029	2,6	1	140
30	2087.7030	3,2	1	141
31	2087.7031	3,2	1	142

M 8-30	4
M 10-35	2
M 10-40	10
M 10-50	4
M 12-30	1
M 12-40	2
M 12-45	1
M 12-70	2
M 12-80	2
M 12-140	2
M 12-160	2
M 14-45	2
M 14-60	4
M 14-130	2
M 16-25	2
M 16-70	2
M 16-90	2
M 16-140	2

M 10	6
M 12	2

**2087.300**

84 Kg 18.07.2006 439-D-14A

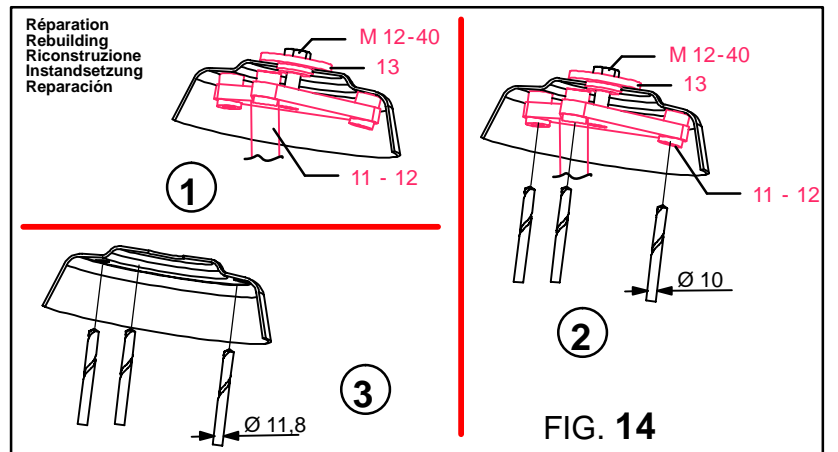
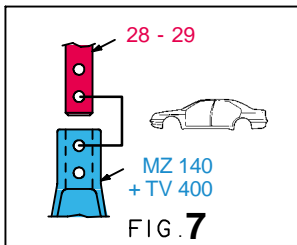
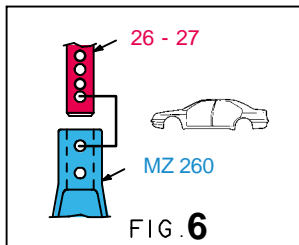
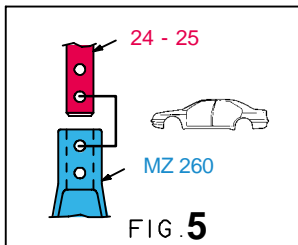
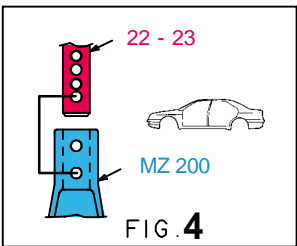
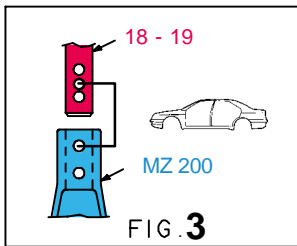
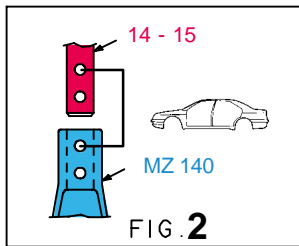
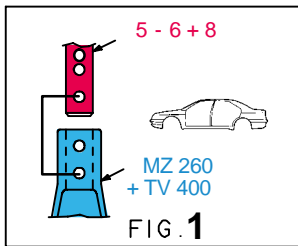
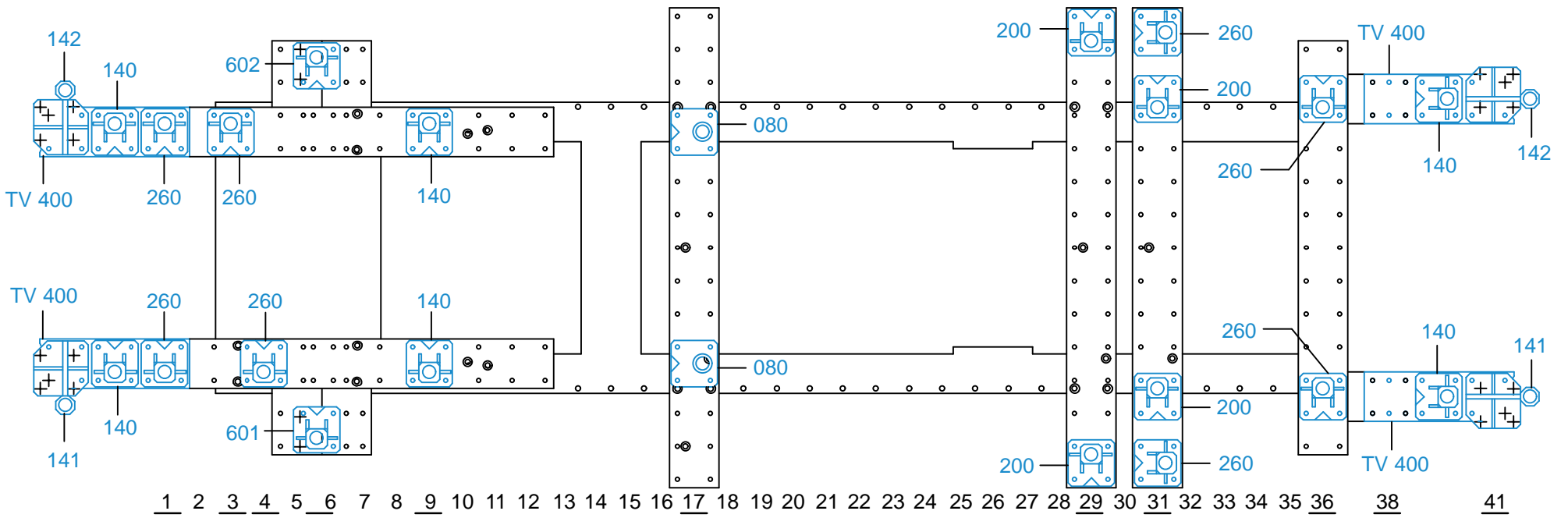

2087.300-RVA3-1 00

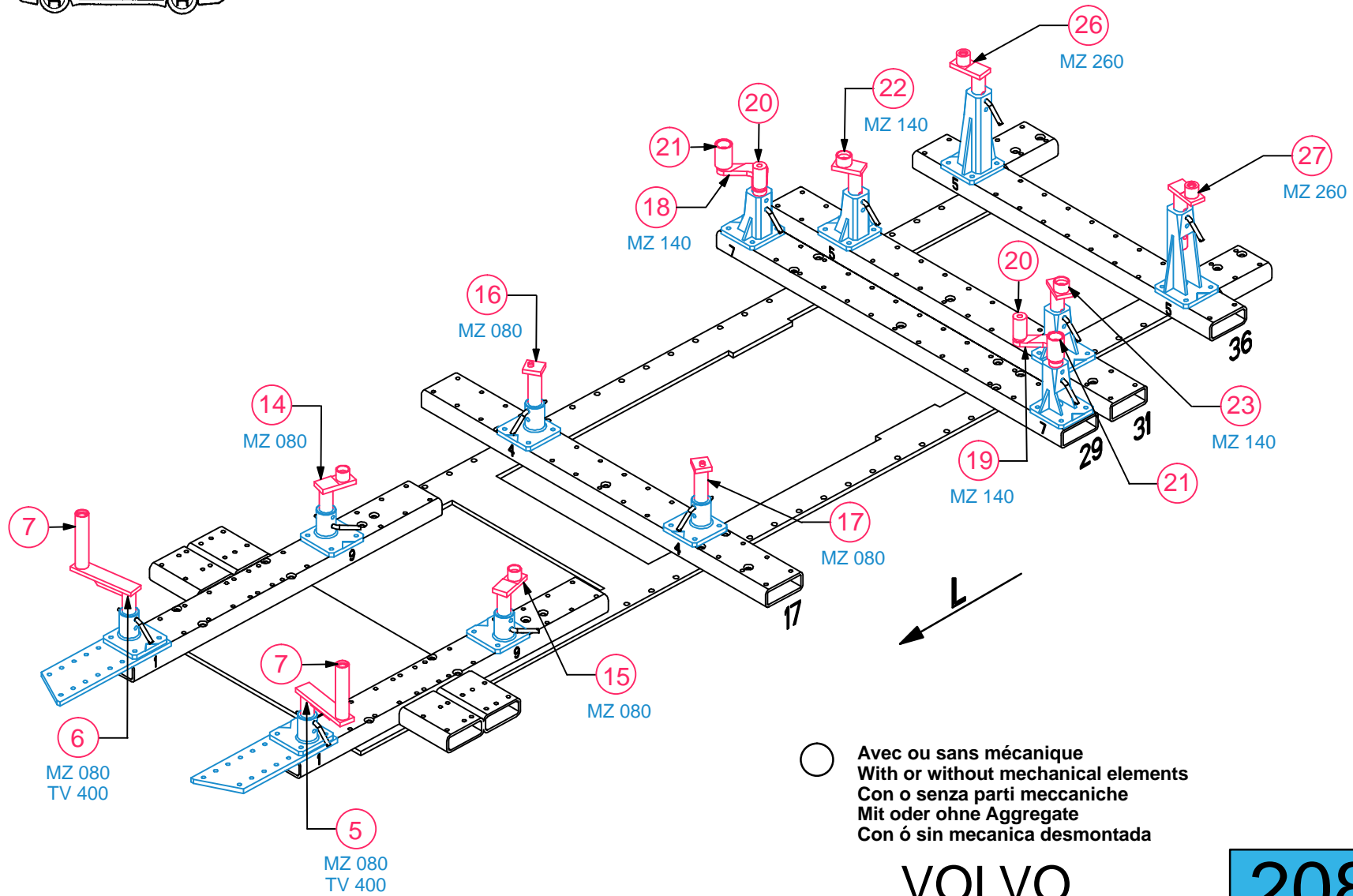
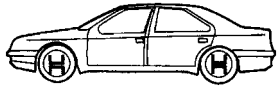

○ Avec ou sans mécanique  
With or without mechanical elements  
Con o senza parti meccaniche  
Mit oder ohne Aggregate  
Con ó sin mecánica desmontada

**VOLVO**

<b>2087.300</b>		
84 Kg	18.07.2006	439-D-14B

