

○ Avec ou sans mécanique  
With or without mechanical elements  
Con o senza parti meccaniche  
Mit oder ohne Aggregate  
Con ó sin mecanica desmontada

REP.	REFERENCE	PDS	NB	MZ
1	2086.7001	3,5	1	141
2	2086.7002	3,5	1	142
3	2086.7003	3,1	1	601
4	2086.7004	3,1	1	602
5	2086.7005	0,4	2	
6	2086.7006	1,4	1	080/260
7	2086.7007	1,4	1	080/260
9	2086.7009	0,7	2	
10	2086.7010	2,8	1	080
11	2086.7011	2,8	1	080
12	2086.7012	2,7	1	260
13	2086.7013	2,4	1	260
14	2086.7014	0,3	4	
15	2086.7015	1,8	1	080
16	2086.7016	1,8	1	080
17	2086.7017	2,8	1	140
18	2086.7018	2,8	1	140
19	2086.7019	2,2	1	200
20	2086.7020	2,2	1	200
21	2086.7021	2,9	1	601
22	2086.7022	2,9	1	602
23	2086.7023	1,9	1	260
24	2086.7024	1,9	1	260

M 10-25	4
M 10-30	8
M 10-35	1
M 12-20	4
M 12-35	1
M 12-60	2
M 12-80	2
M 12-90	4
M 12-110	2

**2086.300**

55 Kg 08.03.2007 411-D-24A

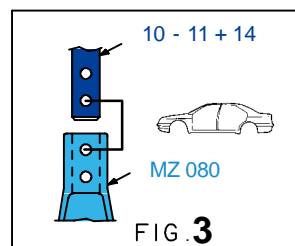
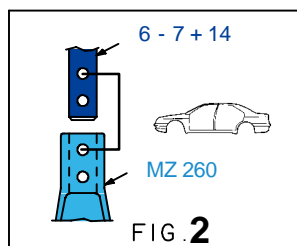
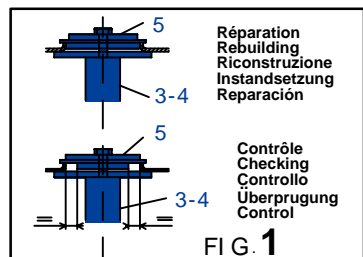
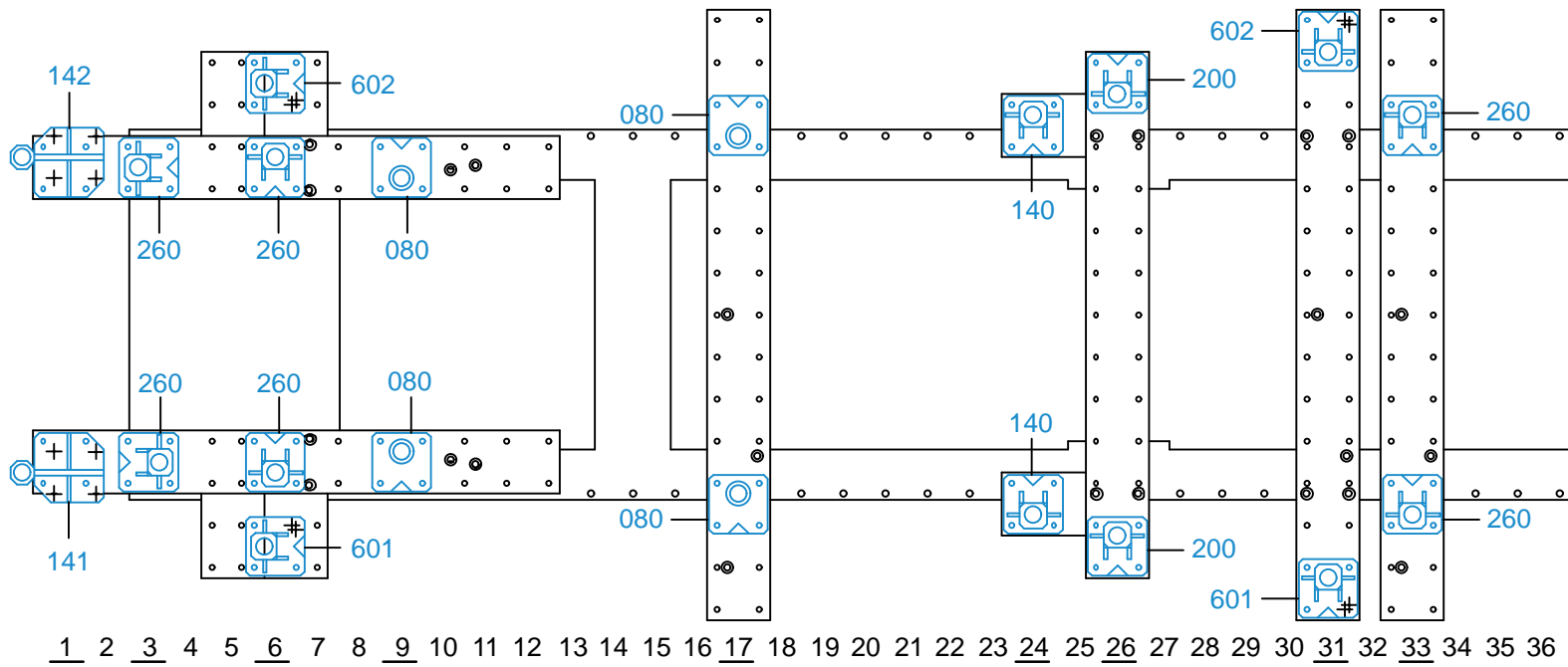

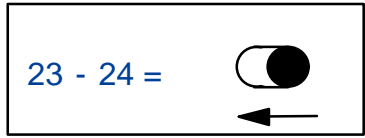
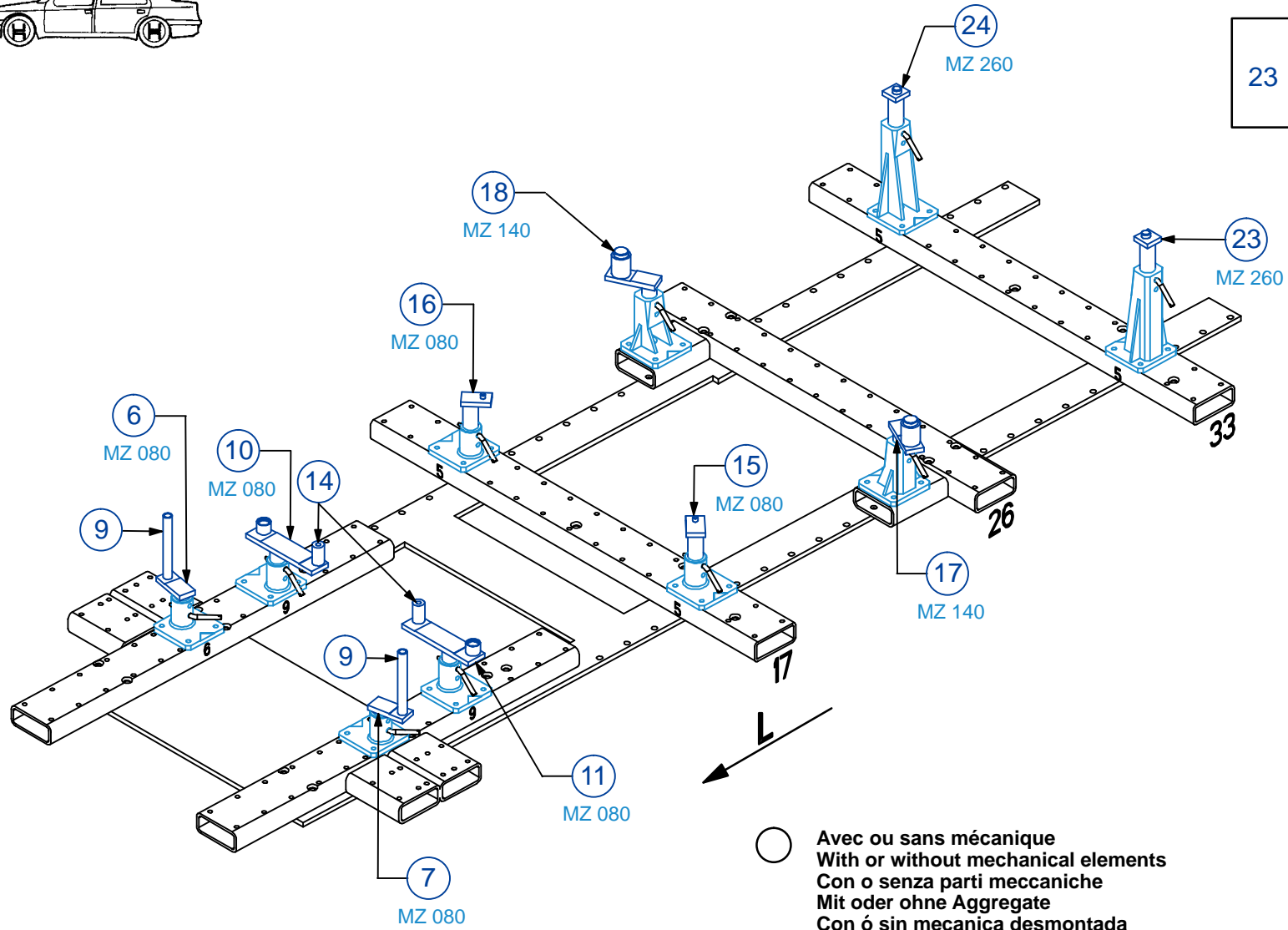
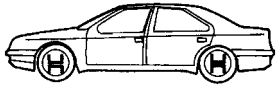

○ Avec ou sans mécanique  
With or without mechanical elements  
Con o senza parti meccaniche  
Mit oder ohne Aggregate  
Con ó sin mecanica desmontada

**FIAT**

<b>2086.300</b>		
55 Kg	26.04.2006	411-D-24B

